

Parker O-Ring Handbook

ORD 5700



ENGINEERING YOUR SUCCESS.

Table of Contents



Failure, improper selection or improper use of the products and/or systems described herein or related items can cause death, personal injury or property damage.

This document and other information from Parker Hannifin Corporation, its subsidiaries and authorized distributors provides product and/or system options for further investigation by users having technical expertise. It is important that you analyze all aspects of your application and review the information concerning the product or system in the current product catalog. Due to the variety of operating conditions and applications for

these products or systems, the user, through his or her own analysis and testing, is solely responsible for making the final selection of the products and systems and assuring that all performance, safety and warning requirements of the application are met.

The products described herein, including without limitation, product features, specifications, designs, availability and pricing, are subject to change by Parker Hannifin Corporation and its subsidiaries at any time without notice.

OFFER OF SALE

The items described in this document are hereby offered for sale by Parker Hannifin Corporation, its subsidiaries and its authorized distributors. This offer and its acceptance are governed by the provisions stated on the separate page of this document entitled "Offer of Sale."

Copyright © 2021, Parker Hannifin Corporation, Cleveland, OH. All rights reserved.

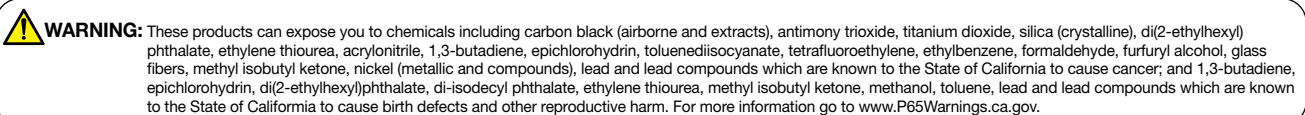

50th Anniversary Edition



Since its initial release in 1957, the Parker O-Ring Handbook has become a fixture on the reference shelves of engineers worldwide. This book contains extensive information about the properties of basic sealing elastomers, as well as examples of typical o-ring applications, fundamentals of static and dynamic seal design and o-ring failure modes. It also provides an overview of international sizes and standards, and compatibility data for fluids, gases and solids.

Engineers in every industry choose o-rings made by Parker Hannifin to keep their equipment running safely and reliably. That's because Parker's O-Ring Division, a developer, manufacturer and supplier of precision-engineered o-rings, offers a unique combination of experience, innovation and support.

Value Added Services through Parker O-Ring Division:

- Desktop seal design – InPhorm software
- Free engineering assistance
- Quality assurance –
 TS 16949 / ISO 9001 / AS 9100 registered
- Premier customer service
- Online tools
 - temperature/dimension converters
 - gland design recommendation charts
 - troubleshooting utility
 - pressure calculator
- ParZap inventory management
- Worldwide distribution
- Extensive product literature, test reports and much more...

⚠ WARNING: These products can expose you to chemicals including carbon black (airborne and extracts), antimony trioxide, titanium dioxide, silica (crystalline), di(2-ethylhexyl) phthalate, ethylene thiourea, acrylonitrile, 1,3-butadiene, epichlorohydrin, toluenediisocyanate, tetrafluoroethylene, ethylbenzene, formaldehyde, furfuryl alcohol, glass fibers, methyl isobutyl ketone, nickel (metallic and compounds), lead and lead compounds which are known to the State of California to cause cancer; and 1,3-butadiene, epichlorohydrin, di(2-ethylhexyl)phthalate, di-isodecyl phthalate, ethylene thiourea, methyl isobutyl ketone, methanol, toluene, lead and lead compounds which are known to the State of California to cause birth defects and other reproductive harm. For more information go to www.P65Warnings.ca.gov.

Table of Contents

Introduction – Section I	1-1
Basic O-Ring Elastomers – Section II	2-1
O-Ring Applications – Section III	3-1
Static O-Ring Sealing – Section IV	4-1
Dynamic O-Ring Sealing – Section V	5-1
Back-up Rings – Section VI	6-1
Compatibility Tables for Gases, Fluids, Solids – Section VII	7-1
Specifications – Section VIII	8-1
Sizes – Section IX	9-1
Appendix – Section X	10-1
Index – Section XI	11-1

 **WARNING:** These products can expose you to chemicals including carbon black (airborne and extracts), antimony trioxide, titanium dioxide, silica (crystalline), di(2-ethylhexyl) phthalate, ethylene thiourea, acrylonitrile, 1,3-butadiene, epichlorohydrin, toluenediisocyanate, tetrafluoroethylene, ethylbenzene, formaldehyde, furfuryl alcohol, glass fibers, methyl isobutyl ketone, nickel (metallic and compounds), lead and lead compounds which are known to the State of California to cause cancer; and 1,3-butadiene, epichlorohydrin, di(2-ethylhexyl)phthalate, di-isodecyl phthalate, ethylene thiourea, methyl isobutyl ketone, methanol, toluene, lead and lead compounds which are known to the State of California to cause birth defects and other reproductive harm. For more information go to www.P65Warnings.ca.gov.

Section I – Introduction

1.0 How to Use This Handbook	1-2	1.8 O-Rings as Drive Belts	1-6
1.1 What is an O-Ring?	1-2	1.9 Custom Molded Shapes	1-6
1.2 What is an O-Ring Seal?	1-2	1.10 Parker Engineering	1-6
1.3 Advantages of O-Rings	1-2	1.11 Comparison of Common Seal Types	1-7
1.4 Operation	1-3	1.12 Recommended Design Procedure	1-7
1.5 O-Ring Characteristics	1-3	1.12.1 O-Ring Design Procedure Using inPHorm™ O-Ring Design & Material Selection Software	1-7
1.6 Limitations of O-Ring Use	1-4	1.12.2 Recommended Manual Design Procedure	1-7
1.7 Scope of O-Ring Use	1-4		
1.7.1 Static Seals	1-5		
1.7.2 Reciprocating Seals	1-5		
1.7.3 Oscillating Seals	1-5		
1.7.4 Rotary Seals	1-5		
1.7.5 Seat Seals	1-5		
1.7.6 Pneumatic Seals	1-5		
1.7.7 Vacuum Seals	1-6		
1.7.8 Cushion Installation	1-6		
1.7.9 Crush Installation	1-6		
1.7.10 Rod Wiper Installation	1-6		

inPHorm™ is a trademark of Parker Hannifin Corporation.

 **WARNING:** These products can expose you to chemicals including carbon black (airborne and extracts), antimony trioxide, titanium dioxide, silica (crystalline), di(2-ethylhexyl) phthalate, ethylene thiourea, acrylonitrile, 1,3-butadiene, epichlorohydrin, toluenediisocyanate, tetrafluoroethylene, ethylbenzene, formaldehyde, furfuryl alcohol, glass fibers, methyl isobutyl ketone, nickel (metallic and compounds), lead and lead compounds which are known to the State of California to cause cancer; and 1,3-butadiene, epichlorohydrin, di(2-ethylhexyl)phthalate, di-isodecyl phthalate, ethylene thiourea, methyl isobutyl ketone, methanol, toluene, lead and lead compounds which are known to the State of California to cause birth defects and other reproductive harm. For more information go to www.P65Warnings.ca.gov.

Introduction

1.0 How to Use This Handbook

For those who are unfamiliar with O-ring design, it is recommended to first study this introductory section, becoming familiar with the basic principles of O-ring seals, their common uses and general limitations.

Those who are already familiar with O-ring seal design may simply refer to the appropriate design tables for the information needed. Even those who have designed many O-ring seals may profit by reviewing the basics from time to time.

1.1 What is an O-Ring?

An O-ring is a torus, or doughnut-shaped ring, generally molded from an elastomer, although O-rings are also made from PTFE and other thermoplastic materials, as well as metals, both hollow and solid. This handbook, however, deals entirely with elastomeric O-rings.

O-rings are used primarily for sealing. The various types of O-ring seals are described in this section under “Scope of O-Ring Use.” O-rings are also used as light-duty, mechanical drive belts. More information, including design criteria on O-ring drive belts and their application will be found in O-Ring Applications, Section III.

1.2 What is an O-Ring Seal?

An O-ring seal is used to prevent the loss of a fluid or gas. The seal assembly consists of an elastomer O-ring and a gland. An O-ring is a circular cross-section ring molded from rubber (Figure 1-1). The gland — usually cut into metal or another rigid material — contains and supports the O-ring (Figures 1-2 and 1-3). The combination of these two elements; O-ring and gland — constitute the classic O-ring seal assembly.

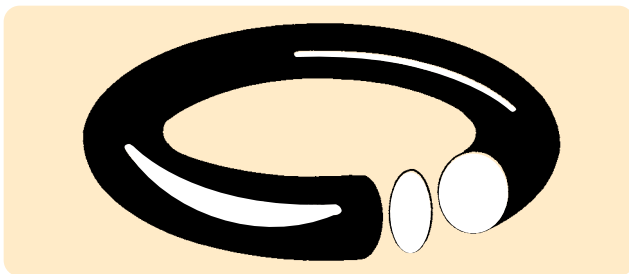

Figure 1-1: Basic O-Ring

1.3 Advantages of O-Rings

- They seal over a wide range of pressure, temperature and tolerance.
- Ease of service, no smearing or retightening.
- No critical torque on tightening, therefore unlikely to cause structural damage.
- O-rings normally require very little room and are light in weight.
- In many cases an O-ring can be reused, an advantage over non-elastic flat seals and crush-type gaskets.
- The duration of life in the correct application corresponds to the normal aging period of the O-ring material.
- O-ring failure is normally gradual and easily identified.
- Where differing amounts of compression effect the seal function (as with flat gaskets), an O-ring is not effected because metal to metal contact is generally allowed for.
- They are cost-effective.

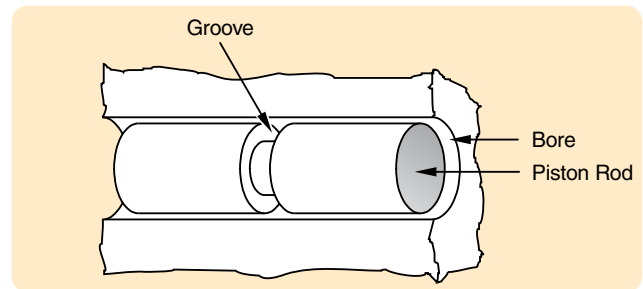

Figure 1-2: Basic Gland

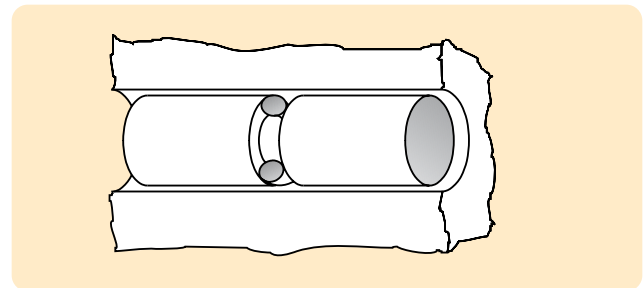

Figure 1-3: Gland and O-Ring Seal

WARNING: These products can expose you to chemicals including carbon black (airborne and extracts), antimony trioxide, titanium dioxide, silica (crystalline), di(2-ethylhexyl) phthalate, ethylene thiourea, acrylonitrile, 1,3-butadiene, epichlorohydrin, toluenediisocyanate, tetrafluoroethylene, ethylbenzene, formaldehyde, furfuryl alcohol, glass fibers, methyl isobutyl ketone, nickel (metallic and compounds), lead and lead compounds which are known to the State of California to cause cancer; and 1,3-butadiene, epichlorohydrin, di(2-ethylhexyl)phthalate, di-isodecyl phthalate, ethylene thiourea, methyl isobutyl ketone, methanol, toluene, lead and lead compounds which are known to the State of California to cause birth defects and other reproductive harm. For more information go to www.P65Warnings.ca.gov.

1.4 Operation

All robust seals are characterized by the absence of any pathway by which fluid or gas might escape. Detail differences exist in the manner by which zero clearance is obtained — welding, brazing, soldering, ground fits or lapped finishes — or the yielding of a softer material wholly or partially confined between two harder and stiffer members of the assembly. The O-ring seal falls in the latter class.

The rubber seal should be considered as essentially an incompressible, viscous fluid having a very high surface tension. Whether by mechanical pressure from the surrounding structure or by pressure transmitted through hydraulic fluid, this extremely viscous fluid is forced to flow within the gland to produce “zero clearance” or block to the flow of the less viscous fluid being sealed. The rubber absorbs the stack-up of tolerances of the unit and its internal memory maintains the sealed condition. Figure 1-4 illustrates the O-ring as installed, before the application of pressure. Note that the O-ring is mechanically squeezed out of round between the outer and inner members to close the fluid passage. The seal material under mechanical pressure extrudes into the microfine grooves of the gland. Figure 1-5 illustrates the application of fluid pressure on the O-ring. Note that the O-ring has been forced to flow up to, but not into, the narrow *gap* between the mating surfaces and in so doing, has gained greater area and force of sealing contact. Figure 1-6 shows the O-ring at its pressure limit with a small portion of the seal material entering the narrow gap between inner and outer members of the gland. Figure 1-7 illustrates the result of further increasing pressure and the resulting extrusion failure. The surface tension of the elastomer is no longer sufficient to resist flow and the material extrudes (flows) into the open passage or clearance gap.

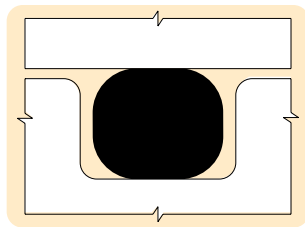

Figure 1-4: O-Ring Installed

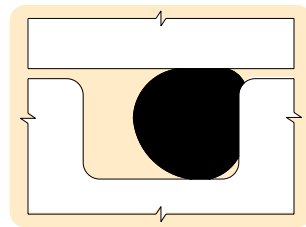

Figure 1-5: O-Ring Under Pressure

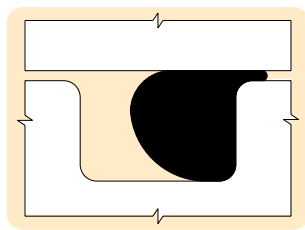

Figure 1-6: O-Ring Extruding

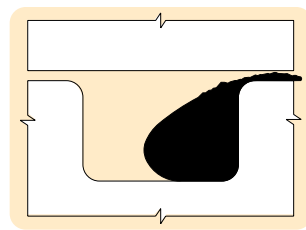

Figure 1-7: O-Ring Failure

1.5 O-Ring Characteristics

A very early and historically prominent user of O-rings⁽¹⁾ cites a number of characteristics of O-ring seals which are still of interest to seal designers. Extracts of the more general characteristics are listed as follows:

Note: While Parker Seal generally agrees with the author on most of his statements, exception will be taken to certain generalizations due to more recent developments in sealing geometry and improved elastomer technology.

- A. The seals can be made perfectly leak-proof for cases of static pistons and cylinders for fluid pressures up to 5000 psi. (Limit of test pressure). The pressure may be constant or variable.
- B. The seals can be made to seal satisfactorily between reciprocating pistons and cylinders at any fluid pressure up to 5000 psi. There may be slight running leakage (a few drops per hundred strokes) depending on the film-forming ability of the hydraulic medium. O-rings can be used between rotating members with similar results but in all cases the surface rubbing speed must be kept low.
- C. A single O-ring will seal with pressure applied alternately on one side and then on the other, but in cases of severe loading or usage under necessarily unfavorable conditions, seal life can be extended by designing the mechanism so that each seal is subjected to pressure in one direction only. Seals may be arranged in series as a safety measure but the first seal exposed to pressure will take the full load.
- D. O-ring seals must be radially compressed between the bottom of the seal groove and the cylinder wall for proper sealing action. This compression may cause the seal to roll slightly in its groove under certain conditions of piston motion, but the rolling action is not necessary for normal operation of the seals.
- E. In either static or dynamic O-ring seals under high pressure the primary cause of seal failure is extrusion of the seal material into the piston-cylinder clearance. The major factors effecting extrusion are fluid pressure, seal hardness and strength, and piston-cylinder clearance.
- F. Dynamic seals may fail by abrasion against the cylinder or piston walls. Therefore, the contacting surfaces should be polished for long seal life. Moving seals that pass over ports or surface irregularities while under hydraulic pressure are very quickly cut or worn to failure.
- G. The shape of the seal groove is unimportant as long as it results in proper compression of the seal between the bottom of the groove and the cylinder wall, and provides room for the compressed material to flow so that the seal is not solidly confined between metal surfaces.
- H. The seal may be housed in a groove cut in the cylinder wall instead of on the piston surface without any change in design limitations or seal performance.

(1) “O-Ring Seals in the Design of Hydraulic Mechanisms”, a paper presented at the S.A.E. Annual Meeting, January, 1947 by Mr. D. R. Pearl of Hamilton Standard Prop. Div. of United Aircraft Corp.

WARNING: These products can expose you to chemicals including carbon black (airborne and extracts), antimony trioxide, titanium dioxide, silica (crystalline), di(2-ethylhexyl) phthalate, ethylene thiourea, acrylonitrile, 1,3-butadiene, epichlorohydrin, toluenediisocyanate, tetrafluoroethylene, ethylbenzene, formaldehyde, furfuryl alcohol, glass fibers, methyl isobutyl ketone, nickel (metallic and compounds), lead and lead compounds which are known to the State of California to cause cancer; and 1,3-butadiene, epichlorohydrin, di(2-ethylhexyl)phthalate, di-isodecyl phthalate, ethylene thiourea, methyl isobutyl ketone, methanol, toluene, lead and lead compounds which are known to the State of California to cause birth defects and other reproductive harm. For more information go to www.P65Warnings.ca.gov.

- I. Friction of moving O-ring seals depends primarily on seal compression, fluid pressure, and projected seal area exposed to pressure. The effects of materials, surfaces, fluids, and speeds of motion are normally of secondary importance, although these variables have not been completely investigated. Friction of O-ring seals under low pressures may exceed the friction of properly designed lip type seals, but at higher pressures, developed friction compares favorably with, and is often less than, the friction of equivalent lip type seals.
- J. The effects of temperature changes from +18°C to +121°C (-65°F to +250°F) on the performance of O-ring seals depends upon the seal material used. Synthetic rubber can be made for continual use at high or low temperatures, or for occasional short exposure to wide variations in temperature. At extremely low temperature the seals may become brittle but will resume their normal flexibility without harm when warmed. Prolonged exposure to excessive heat causes permanent hardening and usually destroys the usefulness of the seal. The coefficient of thermal expansion of synthetic rubber is usually low enough so that temperature changes present no design difficulties. (Note: This may not be true for all elastomer compounds, especially FFKM.)
- K. Chemical interaction between the seal and the hydraulic medium may influence seal life favorably or unfavorably, depending upon the combination of seal material and fluid. Excessive hardening, softening, swelling, and shrinkage must be avoided.
- L. O-ring seals are extremely dependable because of their simplicity and ruggedness. Static seals will seal at high pressure in spite of slightly irregular sealing surfaces and slight cuts or chips in the seals. Even when broken or worn excessively, seals may offer some measure of flow restriction for emergency operation and approaching failure becomes evident through gradual leakage.
- M. The cost of O-ring seals and the machining expense necessary to incorporate them into hydraulic mechanism designs are at least as low as for any other reliable type of seal. O-ring seals may be stretched over large diameters for installation and no special assembly tools are necessary.
- N. Irregular chambers can be sealed, both as fixed or moving-parts installations.

Note: See paragraph 1.3 for additional advantages.

1.6 Limitations of O-Ring Use

Again citing Mr. D. R. Pearl's paper ⁽¹⁾, limitations of O-ring use are given as:

“Although it has been stated that O-rings offer a reasonable approach to the ideal hydraulic seal, they should not be considered the immediate solution to all sealing problems. It has been brought out in the foregoing discussion that there are certain definite limitations on

their use, i.e., high temperature, high rubbing speeds, cylinder ports over which seals must pass and large shaft clearances. Disregard for these limitations will result in poor seal performance. Piston rings, lip type seals, lapped fits, flat gaskets and pipe fittings all have their special places in hydraulic design, but where the design specifications permit the proper use of O-ring seals, they will be found to give long and dependable service.”

While no claim is made that an O-ring will serve best in all conditions, the O-ring merits consideration for most seal applications except:

- A. Rotary speeds exceeding 1500 feet per minute contact speed.
- B. An environment completely incompatible with any elastomeric material.
- C. Insufficient structure to support anything but a flat gasket.

Note: These points are general statements and there are, of course, numerous exceptions. Details of O-ring seal design in regard to particular situations are discussed in the following sections: Applications, Elastomers, Factors Applying To all O-Ring Types, Static O-Ring Seals, and Dynamic O-Ring Seals can be referenced as needed.

1.7 Scope of O-Ring Use

Further discussion in this chapter and in the remainder of this handbook is based on specific types of O-ring seals and special applications. Definitions of commonly used terms connected with O-ring seals are provided in the glossary contained in the Appendix, Section X. These terms are common to the sealing industry.

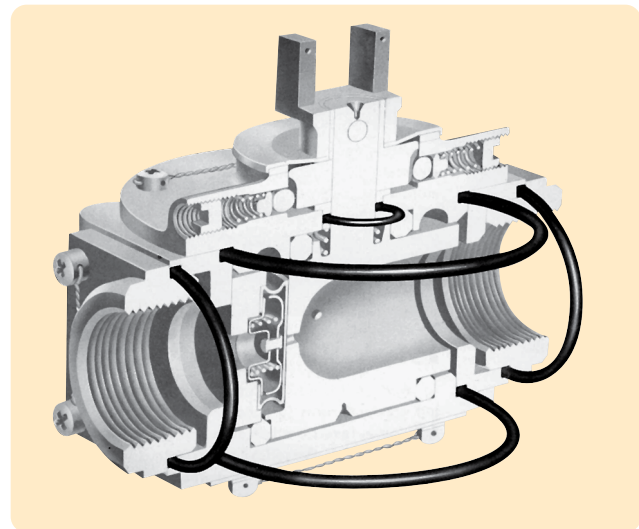

Figure 1-8: Static Seal Application

(1) “O-Ring Seals in the Design of Hydraulic Mechanisms”, a paper presented at the S.A.E. Annual Meeting, January, 1947 by Mr. D. R. Pearl, Hamilton Standard Division of United Aircraft Corp.



WARNING: These products can expose you to chemicals including carbon black (airborne and extracts), antimony trioxide, titanium dioxide, silica (crystalline), di(2-ethylhexyl) phthalate, ethylene thiourea, acrylonitrile, 1,3-butadiene, epichlorohydrin, toluenediisocyanate, tetrafluoroethylene, ethylbenzene, formaldehyde, furfuryl alcohol, glass fibers, methyl isobutyl ketone, nickel (metallic and compounds), lead and lead compounds which are known to the State of California to cause cancer; and 1,3-butadiene, epichlorohydrin, di(2-ethylhexyl)phthalate, di-isodecyl phthalate, ethylene thiourea, methyl isobutyl ketone, methanol, toluene, lead and lead compounds which are known to the State of California to cause birth defects and other reproductive harm. For more information go to www.P65Warnings.ca.gov.

1.7.1 Static Seals

In a truly static seal, the mating gland parts are not subject to relative movement (except for small thermal expansion or separation by fluid pressure), as contrasted from seals in which one of the gland parts has movement relative to the other. Examples of static seals are: a seal under a bolt head or rivet, a seal at a pipe or tubing connection, a seal under a cover plate, plug or similar arrangement or, in general, the equivalent of a flat gasket. Figure 1-8 illustrates a typical static seal.

Note: True static seals are generally quite rare. Vibrational movement is present in virtually all static applications.

1.7.2 Reciprocating Seals

In a reciprocating seal, there is relative reciprocating motion (along the shaft axis) between the inner and outer elements. This motion tends to slide or roll the O-ring, or sealing surface at the O-ring, back and forth with the reciprocal motion. Examples of a reciprocating seal would be a piston in a cylinder, a plunger entering a chamber, and a hydraulic actuator with the piston rod anchored. Figure 1-9 illustrates a typical reciprocating seal.

Note: O-ring seals are generally not recommended for reciprocating installations in which the speed is less than one foot per minute. Consult a Parker Territory Sales Manager for more information on special seals to meet this requirement.

1.7.3 Oscillating Seals

In an oscillating seal, the inner or outer member of the seal assembly moves in an arc (around the shaft axis) relative to the other member. This motion tends to rotate one or the other member in relation to the O-ring. Where the arc of motion exceeds 360°, as in multiple turns to operate a valve handle, the return arc in the opposite direction distinguishes the oscillating seal from a rotary seal. Except for very special cases, any longitudinal motion (as caused by a spiral thread) involved in what is classed as an oscillating seal is not important. An example of an oscillating seal is an O-ring seal for a faucet valve stem. See Figure 1-10.

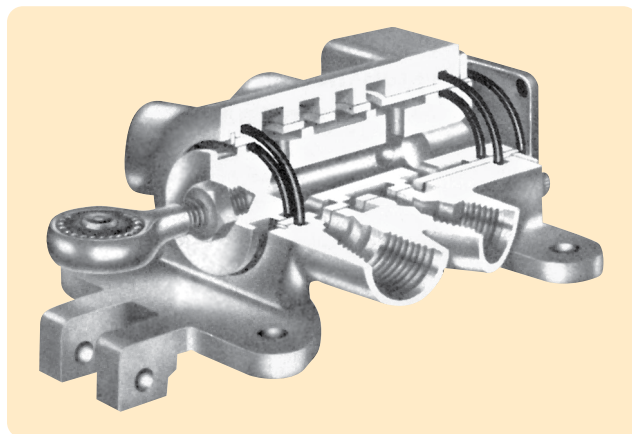

Figure 1-9: Reciprocating Seal Application

1.7.4 Rotary Seals

In a rotary seal, either the inner or outer member of the sealing elements turn (around the shaft axis) in one direction only. This applies when rotation is reversible, but does not allow for starting and stopping after brief arcs of motion, which is classed as an oscillating seal. Examples of a rotary seal include sealing a motor or engine shaft, or a wheel on a fixed axle. See Figure 1-11.

1.7.5 Seat Seals

In a seat seal, the O-ring serves to close a flow passage as one of the contact members. The motion of closing the passage distorts the O-ring mechanically to create the seal, in contrast to conditions of sealing in previously defined types. A sub-classification is closure with impact as compared with non-impact closure. Examples of a seat-seal include O-ring as a “washer” on the face of a spiral threaded valve, a seal on the cone of a floating check valve, and a seal on the end of a solenoid plunger. See Figure 1-12.

1.7.6 Pneumatic Seals

A pneumatic seal may be any of the previously described types of O-ring seals but is given a different classification because of the use of a gas or vapor rather than a liquid. This has a vital affect on the lubrication of the O-ring and thus influences all moving (or dynamic) seal installations. A further point is that pneumatic seals may be affected by the increase in gas temperature with compression. Note that the seal should be defined as “pneumatic-rotary” etc. for complete identification.

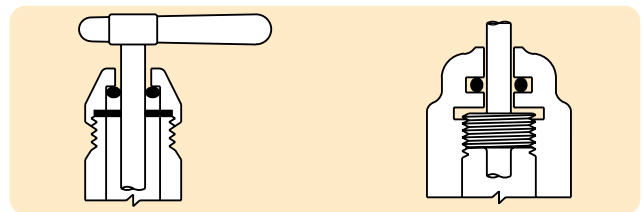

Figure 1-10: Oscillating Seal

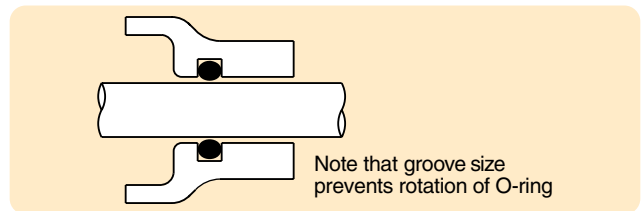

Figure 1-11: Rotary Seal

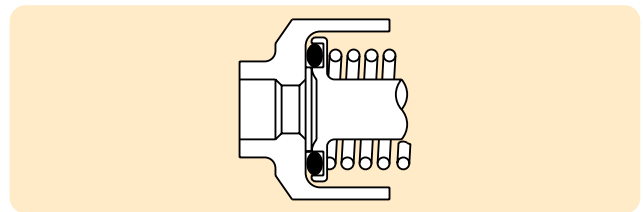

Figure 1-12: Seat Seal

WARNING: These products can expose you to chemicals including carbon black (airborne and extracts), antimony trioxide, titanium dioxide, silica (crystalline), di(2-ethylhexyl) phthalate, ethylene thiourea, acrylonitrile, 1,3-butadiene, epichlorohydrin, toluenediisocyanate, tetrafluoroethylene, ethylbenzene, formaldehyde, furfuryl alcohol, glass fibers, methyl isobutyl ketone, nickel (metallic and compounds), lead and lead compounds which are known to the State of California to cause cancer; and 1,3-butadiene, epichlorohydrin, di(2-ethylhexyl)phthalate, di-isodecyl phthalate, ethylene thiourea, methyl isobutyl ketone, methanol, toluene, lead and lead compounds which are known to the State of California to cause birth defects and other reproductive harm. For more information go to www.P65Warnings.ca.gov.

1.7.7 Vacuum Sealing

A vacuum seal confines or contains a vacuum environment or chamber. The vacuum seal may be any of the previously defined types (except a pneumatic seal) and as in the case of “pneumatic seals”, both terms applicable to the seal should be given for complete identification. This classification is given primarily because, in most cases, the leakage tolerance is less than for pressure seals. In addition, the problem of pressure trapped between multiple O-rings, which increases the load on a single O-ring, does not apply. Multiple O-rings are useful in a vacuum seal to reduce permeation. Additional information on the use of O-rings for sealing in a vacuum environment may be found in Parker Catalog 5705A, Vacuum Sealing. See also Section III, O-Ring Applications.

1.7.8 Cushion Installation

Such an application requires that the O-ring absorb the force of impact or shock by deformation of the ring. Thus, forcible, sudden contact between moving metal parts is prevented. It is essentially a mechanical device. An example is the use of an O-ring to prevent metal-to-metal bottoming of a piston in a cylinder. The O-ring must be properly held in place as otherwise it might shift and interfere with proper operation of the mechanism.

1.7.9 Crush Installation

This use of an O-ring is a variation of the static seal. The O-ring is crushed into a space having a cross-section different from that of a standard gland—for example, triangular. While it is an effective seal, the O-ring is permanently deformed and therefore generally considered non-reusable. See Figure 1-13 and Design Chart 4-6 in Section IV for further information.

1.7.10 Rod Wiper Installation

In this case, the O-ring is used to keep a reciprocating shaft or rod clean to prevent damaging an O-ring seal located in-board from the wiper. The wiper O-ring does not necessarily seal. If there is a possibility of trapping liquid between the wiper and sealing O-rings, the space between the two must be vented. This installation is effective on actuating cylinders of machinery used in dirty, dusty areas. See Figure 1-14.

1.8 O-Rings as Drive Belts

O-rings make superior low-power drive belts. See O-ring Applications, Section III for additional information on drive belt design.

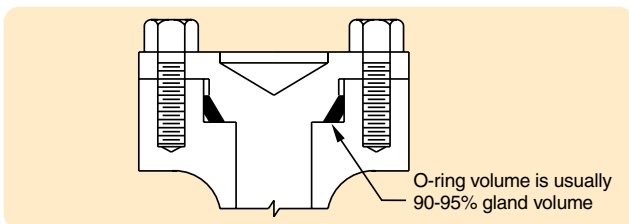

Figure 1-13: Crush Installation

1.9 Custom Molded Shapes

Molded shapes consist of homogenous rubber parts functioning as sealing devices in both dynamic and static applications. Relying on Parker custom designed seals can mean total sealing, cost reduction, fast service, and quality assurance to you. Contact the Parker Engineered Seals Division for more specific information on the availability of custom molded shapes.

1.10 Parker Engineering

Parker’s Application Engineering Department personnel are prepared to help you solve your sealing problems in several ways:

Design Assistance

Our engineers will review your application, study all factors involved such as temperatures, pressures, gland design, bolt torque, surface finish, etc., and suggest several alternate designs. They will work with you in researching and testing those selected until the best possible seal is achieved, based on performance and low manufacturing cost.

Compound Development

Although the geometric configuration of the seal is critical, it is also very important to select the most appropriate compound for the specific application. Even though Parker has many compounds available, we are always ready to develop a special compound having its own distinct properties tailored to the needs of a particular application. To insure that these physical properties are achieved with each batch of material, Parker has designed a control system called “C.B.I.” The initials “C.B.I.” stand for “Controlled Batch Identification”. This is a system of batch numbering and traceability developed by Parker Seal Group which ties the quality assurance system together from the masterbatch to the finished seals.

Total Quality Management

The Parker Seal Group employs a TS16949/AS9100 based system to assure a continuing standard of quality that is commensurate with good manufacturing practices. However, in many cases — as in custom designed molded shapes — a special quality assurance procedure will be developed for each individual molded shape with emphasis on the importance of the actual working area (or sealing interface) of the seal.

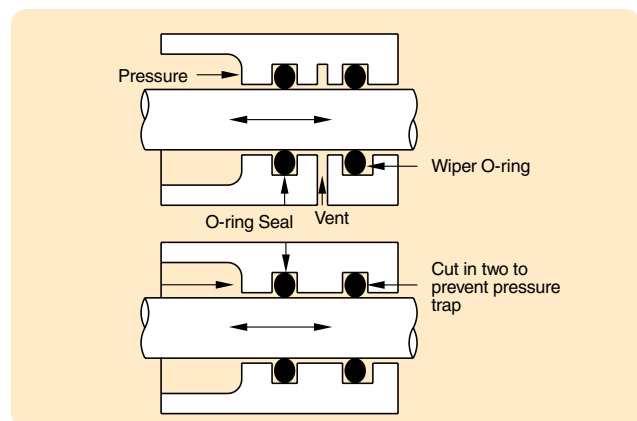

Figure 1-14: Wiper Installation



WARNING: These products can expose you to chemicals including carbon black (airborne and extracts), antimony trioxide, titanium dioxide, silica (crystalline), di(2-ethylhexyl) phthalate, ethylene thiourea, acrylonitrile, 1,3-butadiene, epichlorohydrin, toluenediisocyanate, tetrafluoroethylene, ethylbenzene, formaldehyde, furfuryl alcohol, glass fibers, methyl isobutyl ketone, nickel (metallic and compounds), lead and lead compounds which are known to the State of California to cause cancer; and 1,3-butadiene, epichlorohydrin, di(2-ethylhexyl)phthalate, di-isodecyl phthalate, ethylene thiourea, methyl isobutyl ketone, methanol, toluene, lead and lead compounds which are known to the State of California to cause birth defects and other reproductive harm. For more information go to www.P65Warnings.ca.gov.

1.11 Comparison of Common Seal Types

A number of common seal types, T-Seals, U-Cups, V-Packing and other devices, have been, and are still used for both dynamic and static seals. When compared with an O-ring seal, these other seal types may show one or more design disadvantages which might be overcome by use of an O-ring. As an aid in assessing the relative merits of an O-ring seal, Table 1-1 lists several of the important factors that must be considered in the selection of any effective seal geometry.

1.12 Recommended Design Procedure

The following design steps are recommended for the designer/engineer who is not familiar with O-ring seals:

- O-Ring Design Procedure using inPHorm O-Ring Design & Material Selection Software described in paragraph 1.12.1
- Recommended Manual Design Procedure described in paragraph 1.12.2

1.12.1 O-Ring Design Procedure using inPHorm O-Ring Design & Material Selection Software.

Parker recommends utilizing our inPHorm design software to guide the user through the design and selection of an O-ring and corresponding seal gland. Parker's inPHorm not only addresses standard O-ring sizes, but allows the user to custom design O-ring glands and seals specifically for their application. To obtain inPHorm software, contact Parker Product Information at 1-800-C-PARKER or download from www.parkerorings.com. If inPHorm is not readily available manual calculations can be performed using the following guidelines.

1.12.2 Recommended Manual Design Procedure

1. Study the Basic O-Ring Elastomers and O-Ring Applications Sections (II and III, respectively) to see how a compound is selected, learn the effects of various environments on them, and become familiar with those considerations that apply to all O-ring seal glands.

2. Check the Appendix, Section X, for the compound shrinkage class tables. If it is not AN shrinkage, it may be necessary to compensate in the gland design for best sealing results.
3. Find the recommended O-ring size and gland dimensions in the appropriate design table in Static O-Ring Sealing or Dynamic O-Ring Sealing, Sections IV and V, respectively.
4. For industrial use, order the O-rings by the Parker compound number followed by the appropriate size number.

Example: N0674-70 2-325

For the experienced O-ring seal designer:

1. Determine the gland design for best sealing results.
 - (a) If the fluid medium or its specification is known, refer to the Fluid Compatibility Tables in Section VII or to the various material or other specifications listed in Section VIII.
 - (b) If the compound specification is known, refer to Table 8-2, Table 8-3 or Table 8-4 in Section VIII as applicable.
2. Check the Appendix, Section X, for the compound shrinkage class tables. If it is not AN shrinkage, it may be necessary to compensate in the gland design for best sealing results.
3. Find the recommended O-ring size and gland dimensions in the appropriate design table in Static O-Ring Sealing or Dynamic O-Ring Sealing, Sections IV and V, respectively.
4. For industrial use, order the O-rings by the Parker compound number followed by the size number.

Example: N0674-70 2-325

When ordering parts made with a military, AMS, or NAS specification material, see the Specifications Section VIII.

Example: M83248/1-325

5. For a design problem that cannot be resolved using the information in this reference guide, fill out a copy of the "Statement of Problem" sheet, Table 1-2, as completely as possible, then Contact the Parker O-Ring Division for problem analysis and design recommendations.

Comparison of Seal Types

Type	Applications		Periodic Adjustment Required	Moving Friction	Tolerances Required (Moving Seals)	Gland Adapters Required	Space Requirements
	Static	Moving					
O-Ring	X	X	No	Medium	Close	No	Small
T-Seal	X	X	No	Medium	Fairly Close	No	Small
U-Packing	—	X	No	Low	Close	No	Small
V-Packing	—	X	Yes	Medium	Fairly Close	Yes	Large
Cup Type Packing	—	X	No	Medium	Close	Yes	Medium
Flat Gasket	X	—	Yes	—	—	No	Large
Compression or Jam Packing	X	X	Yes	High	Fairly Close	Yes	Large

Table 1-1: Comparison of Seal Types

WARNING: These products can expose you to chemicals including carbon black (airborne and extracts), antimony trioxide, titanium dioxide, silica (crystalline), di(2-ethylhexyl) phthalate, ethylene thiourea, acrylonitrile, 1,3-butadiene, epichlorohydrin, toluenediisocyanate, tetrafluoroethylene, ethylbenzene, formaldehyde, furfuryl alcohol, glass fibers, methyl isobutyl ketone, nickel (metallic and compounds), lead and lead compounds which are known to the State of California to cause cancer; and 1,3-butadiene, epichlorohydrin, di(2-ethylhexyl)phthalate, di-isodecyl phthalate, ethylene thiourea, methyl isobutyl ketone, methanol, toluene, lead and lead compounds which are known to the State of California to cause birth defects and other reproductive harm. For more information go to www.P65Warnings.ca.gov.

Statement of Problem

1. Seal Type			
2. Fluid Sealed (In sequence if multiple)	A.	B.	
	C.	D.	Material Spec.
3. Temperature	High	Low	Working
4. Pressure	High	Low	Working
5. Applied Pressure	Uni-Directional	Steady	Surge
	Bi-Directional	Fluctuating	Frequency
6. Gland Dimensions (If separate, groove wall)	OD	Finish	Material
	ID	Finish	Material
		Finish	Material
7. Max. Stretch at Installation			
8. Assembly Problems	Dirt	Lint	Lube
	Twisted	Blind	Pinching
	Over Threads	Corners, Holes, Etc.	

Moving Seals

9. Length of Stroke (Reciprocating)	Arc of Travel (Oscillating)		
	Surface Speed (Rotary)		
10. Shaft Bearings	No		
	Side Loading Effect		
11. Operating Clearance	Max.	Min.	
12. Leakage Tolerance			
13. Friction Tolerance	Breakaway	Running	
14. Anticipated Overhaul Period			
Ease of Access and Replacement			
15. Lubrication	By Fluid Sealed	External	
16. Cleanliness	Protected	Open	Bad
O-Ring Size No.	And Parker Compound No.	Or Military Part No.	
17. Please include a drawing or sketch if needed to clarify the assembly, and add any other pertinent information.			

NOTE: For O-rings molded of compounds having other than standard shrinkage, determine the finished dimensions and tolerances as described in the Appendix (Section X).

Table 1-2: Statement of Problem

WARNING: These products can expose you to chemicals including carbon black (airborne and extracts), antimony trioxide, titanium dioxide, silica (crystalline), di(2-ethylhexyl) phthalate, ethylene thiourea, acrylonitrile, 1,3-butadiene, epichlorohydrin, toluenediisocyanate, tetrafluoroethylene, ethylbenzene, formaldehyde, furfuryl alcohol, glass fibers, methyl isobutyl ketone, nickel (metallic and compounds), lead and lead compounds which are known to the State of California to cause cancer; and 1,3-butadiene, epichlorohydrin, di(2-ethylhexyl)phthalate, di-isodecyl phthalate, ethylene thiourea, methyl isobutyl ketone, methanol, toluene, lead and lead compounds which are known to the State of California to cause birth defects and other reproductive harm. For more information go to www.P65Warnings.ca.gov.

Section II – Basic O-Ring Elastomers

2.0 Elastomers	2-2	2.4.16 Permeability	2-18
2.1 Introduction to Elastomers	2-2	2.4.17 Joule Effect	2-18
2.1.1 Polymer	2-2	2.4.18 Coefficient of Friction	2-19
2.1.2 Rubber	2-3	2.4.19 Electrical Properties	2-19
2.1.3 Elastomer	2-3	2.4.20 Coefficient of Thermal Expansion	2-19
2.1.4 Compound	2-3	2.4.21 Effects on Properties	2-20
2.2 Basic Elastomers for O-Ring Seals	2-3	2.5 Standard Test Procedures	2-20
2.2.1 Acrylonitrile-Butadiene (NBR)	2-3	2.5.1 Test Specimens	2-20
2.2.2 Carboxylated Nitrile (XNBR)	2-4	2.5.2 Test Method Variables	2-20
2.2.3 Ethylene Acrylate (AEM, Vamac®)	2-4	2.5.3 Effects of Environment on Testing	2-20
2.2.4 Ethylene Propylene Rubber (EPR, EPDM)	2-4	2.6 Aging	2-21
2.2.5 Butyl Rubber (IIR)	2-4	2.7 Storage	2-21
2.2.6 Chloroprene Rubber (CR)	2-5	2.8 Cure Date	2-21
2.2.7 Fluorocarbon (FKM, FPM)	2-5	2.9 Age Control	2-21
2.2.8 Fluorosilicone (FVMQ)	2-5	2.10 Shrinkage	2-21
2.2.9 Hydrogenated Nitrile (HNBR)	2-5	2.11 Compound Selection	2-22
2.2.10 Perfluoroelastomer (FFKM)	2-6	2.11.1 Non-Pioneering Design	2-22
2.2.11 Polyacrylate (ACM)	2-6	2.11.2 Pioneering Design	2-22
2.2.12 Polyurethane (AU, EU)	2-6	2.12 Rapid Methods for Predicting the Compatibility of Elastomers with Mineral Based Oils	2-22
2.2.13 Silicone Rubber (Q, MQ, VMQ, PVMQ)	2-6	2.12.1 Aniline Point Differences	2-22
2.2.14 Tetrafluoroethylene-Propylene (AFLAS®) (FEPM)	2-6	2.12.2 Elastomer Compatibility Index	2-23
2.3 Compound Selection and Numbering Systems	2-7	2.13 Operating Conditions	2-24
2.3.1 Selection of Base Polymer	2-7	2.13.1 Fluid	2-24
2.4 Physical and Chemical Characteristics	2-8	2.13.2 Temperature	2-25
2.4.1 Resistance to Fluid	2-8	2.13.3 Time	2-26
2.4.2 Hardness	2-9	2.13.4 Pressure	2-26
2.4.3 Toughness	2-10	2.13.5 Mechanical Requirements	2-28
2.4.4 Tensile Strength	2-10	2.14 Selecting a Compound	2-28
2.4.5 Elongation	2-10	2.15 Compound Similarity	2-28
2.4.6 O-Ring Compression Force	2-10	2.16 Testing	2-28
2.4.7 Modulus	2-13	2.17 Specifications	2-29
2.4.8 Tear Resistance	2-13	2.18 Qualification Testing	2-30
2.4.9 Abrasion Resistance	2-13	2.18.1 Original Physical Properties	2-30
2.4.10 Volume Change	2-13	2.18.2 Aged Physical Control	2-30
2.4.11 Compression Set	2-14	2.19 Process Control	2-31
2.4.12 Thermal Effects	2-17		
2.4.13 Resilience	2-18		
2.4.14 Deterioration	2-18		
2.4.15 Corrosion	2-18		

Vamac® is a registered trademark of E.I. du Pont de Nemours & Co.
AFLAS® is a registered trademark of Asahi Glass Co., Ltd.

WARNING: These products can expose you to chemicals including carbon black (airborne and extracts), antimony trioxide, titanium dioxide, silica (crystalline), di(2-ethylhexyl) phthalate, ethylene thiourea, acrylonitrile, 1,3-butadiene, epichlorohydrin, toluenediisocyanate, tetrafluoroethylene, ethylbenzene, formaldehyde, furfuryl alcohol, glass fibers, methyl isobutyl ketone, nickel (metallic and compounds), lead and lead compounds which are known to the State of California to cause cancer; and 1,3-butadiene, epichlorohydrin, di(2-ethylhexyl)phthalate, di-isodecyl phthalate, ethylene thiourea, methyl isobutyl ketone, methanol, toluene, lead and lead compounds which are known to the State of California to cause birth defects and other reproductive harm. For more information go to www.P65Warnings.ca.gov.

Basic O-Ring Elastomers

2.0 Elastomers

The basic core polymer of an elastomeric compound is called a rubber, produced either as natural gum rubber in the wild, on commercial rubber plantations or manufactured synthetically by the chemical industry. Today, more than 32 synthetic rubbers are known, the most important ones are listed in Table 2-1.

Modern elastomeric sealing compounds generally contain 50 to 60% base polymer and are often described simply as “rubber.” The balance of an elastomer compound consists of various fillers, vulcanizing agents, accelerators, aging retardants and other chemical additives which modify and improve the basic physical properties of the base polymer to meet the particular requirements of a specific application.

Elastomers used in producing seals, and particularly those used in O-rings, will usually provide reliable, leak-free function if fundamental design requirements are observed.

“Cross-linking” between the polymer chains is formed during the vulcanization process, see Figure 2-1. Cross-linking of the molecules changes the rubber from a plastic-like material to an elastic material.

After vulcanization, including any required “post-cure,” an elastomer compound attains the physical properties required for a good sealing material. As with all chemical reactions, temperature is responsible for the speed of reaction. Only when the ideal process temperature is constant during the entire vulcanization time, will the optimum degree of curing be reached. For this reason, the conditions of vulcanization are closely controlled and recorded as part of the Parker quality assurance process.

2.1 Introduction to Elastomers

Before reviewing the available elastomers and their general properties, it is necessary to fully understand the terms “polymer,” “rubber,” “elastomer” and “compound” as they are used in this handbook.

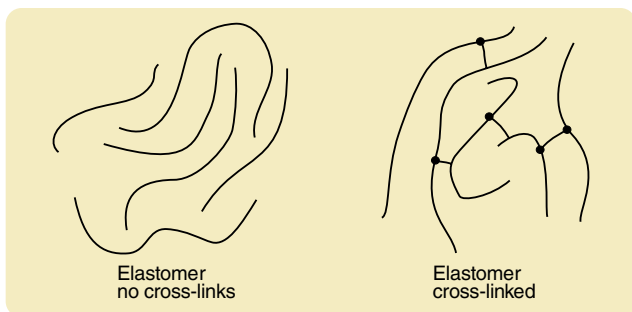

Figure 2-1: Schematic Representation of Polymer Chains Before and After Vulcanization

2.1.1 Polymer

A polymer is the “result of a chemical linking of molecules into a long chain-like structure.” Both plastics and elastomers are classified as polymers. In this handbook, polymer generally refers to a basic class of elastomer, members of which have similar chemical and physical properties. O-rings are made from many polymers, but a few polymers account for the majority of O-rings produced, namely Nitrile, EPDM and Neoprene.

Synthetic Rubber

Chemical Name	Abbreviation	
	DIN/ISO 1629	ASTM D1418
M-Group (saturated carbon molecules in main macro-molecule chain):		
Polyacrylate Rubber	ACM	ACM
Ethylene Acrylate	—	AEM
Chlorosulfonated Polyethylene Rubber	CSM	CSM
Ethylene Propylene Diene Rubber	EPDM	EPDM
Ethylene Propylene Rubber	EPDM	EPM
Fluorocarbon Rubber	FPM	FKM
Tetrafluoroethylene Propylene Copolymer	FEPM	FEPM
Perfluorinated Elastomer	—	FFKM
O-Group (with oxygen molecules in the main macro-molecule chain):		
Epichlorohydrin Rubber	CO	CO
Epichlorohydrin Copolymer Rubber	ECO	ECO
R-Group (unsaturated hydrogen carbon chain):		
Butadiene Rubber	BR	BR
Chloroprene Rubber	CR	CR
Isobutene Isoprene Rubber (Butyl Rubber)	IIR	IIR
Chlorobutyl Rubber	CIIR	CIIR
Isoprene Rubber	IR	IR
Nitrile Butadiene Rubber	NBR	NBR
Styrene Butadiene Rubber	SBR	SBR
Hydrogenated Nitrile	—	HNBR
Carboxylated Nitrile	XNBR	XNBR
Q-Group (with Silicone in the main chain):		
Fluorosilicone Rubber	FMQ	FVMQ
Methyl Phenyl Silicone Rubber	PMQ	PMQ
Methyl Phenyl Vinyl Silicone Rubber	PMVQ	PVMQ
Methyl Silicone Rubber	MQ	MQ
Methyl Vinyl Silicone Rubber	VMQ	VMQ
U-Group (with carbon, oxygen and nitrogen in the main chain):		
Polyester Urethane	AU	AU
Polyether Urethane	EU	EU

Table 2-1: The Most Important Types of Synthetic Rubber, Their Groupings and Abbreviations



WARNING: These products can expose you to chemicals including carbon black (airborne and extracts), antimony trioxide, titanium dioxide, silica (crystalline), di(2-ethylhexyl) phthalate, ethylene thiourea, acrylonitrile, 1,3-butadiene, epichlorohydrin, toluenediisocyanate, tetrafluoroethylene, ethylbenzene, formaldehyde, furfuryl alcohol, glass fibers, methyl isobutyl ketone, nickel (metallic and compounds), lead and lead compounds which are known to the State of California to cause cancer; and 1,3-butadiene, epichlorohydrin, di(2-ethylhexyl)phthalate, di-isodecyl phthalate, ethylene thiourea, methyl isobutyl ketone, methanol, toluene, lead and lead compounds which are known to the State of California to cause birth defects and other reproductive harm. For more information go to www.P65Warnings.ca.gov.

2.1.2 Rubber

Rubber-like materials first produced from sources other than rubber trees were referred to as “synthetic rubber.” This distinguished them from natural gum rubber. Since then, usage in the industry has broadened the meaning of the term “rubber” to include both natural as well as synthetic materials having rubber-like qualities. This handbook uses the broader meaning of the word “rubber.”

2.1.3 Elastomer

Though “elastomer” is synonymous with “rubber,” it is formally defined as a “high molecular weight polymer that can be, or has been modified, to a state exhibiting little plastic flow and rapid, nearly complete recovery from an extending or compressing force.” In most instances we call such material before modification “uncured” or “unprocessed” rubber or polymer.

When the basic high molecular weight polymer, without the addition of plasticizers or other dilutents, is converted by appropriate means to an essentially non-plastic state and tested at room temperature, it usually meets the following requirements in order to be called an elastomer:

- A. It must not break when stretched approximately 100%.
- B. After being held for five minutes at 100% stretch, it must retract to within 10% of its original length within five minutes of release.

Note: Extremely high hardness/modulus materials generally do not exhibit these properties even though they are still considered elastomers.

The American Society for Testing and Materials (ASTM) uses these criteria to define the term “elastomer.”

2.1.4 Compound

A compound is a mixture of base polymer and other chemicals that form a finished rubber material. More precisely, a compound refers to a specific blend of chemical ingredients tailored for particular required characteristics to optimize performance in some specific service.

The basis of compound development is the selection of the polymer type. There may be a dozen or more different ones to choose from. The rubber compounder may then add various reinforcing agents such as carbon black, curing or

vulcanizing agents (such as sulfur or peroxide, activators, plasticizers, accelerators, antioxidants, or antiozonants) to the elastomer mixture to tailor it into a seal compound with its own distinct physical properties. Since compounders have thousands of compounding ingredients at their disposal, it seems reasonable to visualize two, three, or even one hundred-plus compounds having the same base elastomer, yet exhibiting marked performance differences in the O-ring seal.

The terms “compound” and “elastomer” are often used interchangeably in a more general sense. This usage usually references a particular type or class of materials such as “nitrile compounds” or “butyl elastomers.” Please remember that when one specific compound is under discussion in this handbook, it is a blend of various compounding ingredients (including one or more base elastomers) with its own individual characteristics and identification in the form of a unique compound number. For example, N0674-70 or V1164-75.

2.2 Basic Elastomers for O-Ring Seals

The following paragraphs briefly review the various elastomers currently available for use in O-rings and other elastomeric seals. If any of the rubber terms used in the descriptions are confusing, consult the “Glossary of Seal and Rubber Terms” in the Appendix, Section X. Service recommendations mentioned in this section are necessarily abbreviated. For more comprehensive and specific information on this important subject, see the Fluid Compatibility Tables in Section VII.

2.2.1 Acrylonitrile-Butadiene (NBR)

Nitrile rubber (NBR) is the general term for acrylonitrile butadiene copolymer. The acrylonitrile content of nitrile sealing compounds varies considerably (18% to 50%) and influences the physical properties of the finished material.

The higher the acrylonitrile content, the better the resistance to oil and fuel. At the same time, elasticity and resistance to compression set is adversely affected. In view of these opposing realities, a compromise is often drawn, and a medium acrylonitrile content selected. NBR has good mechanical properties when compared with other elastomers and high wear resistance. NBR is not resistant to weathering and ozone. See Figure 2-2.

Heat resistance

- Up to 100°C (212°F) with shorter life @ 121°C (250°F).

Cold flexibility

- Depending on individual compound, between -34°C and -57°C (-30°F and -70°F).

Chemical resistance

- Aliphatic hydrocarbons (propane, butane, petroleum oil, mineral oil and grease, diesel fuel, fuel oils) vegetable and mineral oils and greases.
- HFA, HFB and HFC hydraulic fluids.
- Dilute acids, alkali and salt solutions at low temperatures.
- Water (special compounds up to 100°C) (212°F).

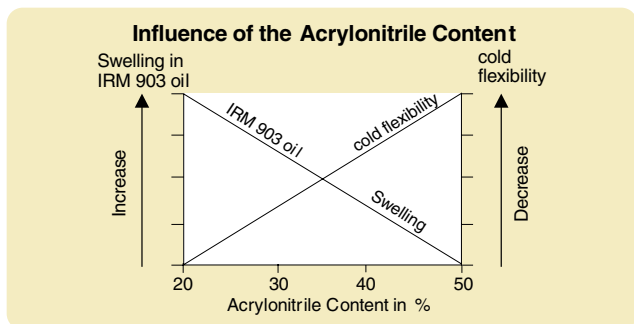

Figure 2-2: Influence of the Acrylonitrile Content

WARNING: These products can expose you to chemicals including carbon black (airborne and extracts), antimony trioxide, titanium dioxide, silica (crystalline), di(2-ethylhexyl) phthalate, ethylene thiourea, acrylonitrile, 1,3-butadiene, epichlorohydrin, toluenediisocyanate, tetrafluoroethylene, ethylbenzene, formaldehyde, furfuryl alcohol, glass fibers, methyl isobutyl ketone, nickel (metallic and compounds), lead and lead compounds which are known to the State of California to cause cancer; and 1,3-butadiene, epichlorohydrin, di(2-ethylhexyl)phthalate, di-isodecyl phthalate, ethylene thiourea, methyl isobutyl ketone, methanol, toluene, lead and lead compounds which are known to the State of California to cause birth defects and other reproductive harm. For more information go to www.P65Warnings.ca.gov.

Not compatible with:

- Fuels of high aromatic content (for flex fuels a special compound must be used).
- Aromatic hydrocarbons (benzene).
- Chlorinated hydrocarbons (trichloroethylene).
- Polar solvents (ketone, acetone, acetic acid, ethylene-ester).
- Strong acids.
- Brake fluid with glycol base.
- Ozone, weather and atmospheric aging.

2.2.2 Carboxylated Nitrile (XNBR)

Carboxylated Nitrile (XNBR) is a special type of nitrile polymer that exhibits enhanced tear and abrasion resistance. For this reason, XNBR based materials are often specified for dynamic applications such as rod seals and rod wipers.

Heat resistance

- Up to 100°C (212°F) with shorter life @ 121°C (250°F).

Cold flexibility

- Depending on individual compound, between -18°C and -48°C (0°F and -55°F).

Chemical resistance

- Aliphatic hydrocarbons (propane, butane, petroleum oil, mineral oil and grease, diesel fuel, fuel oils) vegetable and mineral oils and greases.
- HFA, HFB and HFC hydraulic fluids.
- Many diluted acids, alkali and salt solutions at low temperatures.

Not compatible with:

- Fuels of high aromatic content (for flex fuels a special compound must be used).
- Aromatic hydrocarbons (benzene).
- Chlorinated hydrocarbons (trichloroethylene).
- Polar solvents (ketone, acetone, acetic acid, ethylene-ester).
- Strong acids.
- Brake fluid with glycol base.
- Ozone, weather and atmospheric aging.

2.2.3 Ethylene Acrylate (AEM, Vamac)

Ethylene acrylate is a terpolymer of ethylene and methyl acrylate with the addition of a small amount of carboxylated curing monomer. Ethylene acrylate rubber is not to be confused with polyacrylate rubber (ACM).

Heat resistance

- Up to 149°C (300°F) with shorter life up to 163°C (325°F).

Cold flexibility

- Between -29°C and -40°C (-20°F and -40°F).

Chemical resistance

- Ozone.
- Oxidizing media.
- Moderate resistance to mineral oils.

Not compatible with:

- Ketones.
- Fuels.
- Brake fluids.

2.2.4 Ethylene Propylene Rubber (EPR, EPDM)

EPR copolymer ethylene propylene and ethylene-propylene-diene rubber (EPDM) terpolymer are particularly useful when sealing phosphate-ester hydraulic fluids and in brake systems that use fluids having a glycol base.

Heat resistance

- Up to 150°C (302°F) (max. 204°C (400°F)) in water and/or steam).

Cold flexibility

- Down to approximately -57°C (-70°F).

Chemical resistance

- Hot water and steam up to 149°C (300°F) with special compounds up to 260°C (500°F).
- Glycol based brake fluids (Dot 3 & 4) and silicone-based brake fluids (Dot 5) up to 149°C (300°F).
- Many organic and inorganic acids.
- Cleaning agents, sodium and potassium alkalis.
- Phosphate-ester based hydraulic fluids (HFD-R).
- Silicone oil and grease.
- Many polar solvents (alcohols, ketones, esters).
- Ozone, aging and weather resistant.

Not compatible with:

- Mineral oil products (oils, greases and fuels).

2.2.5 Butyl Rubber (IIR)

Butyl (isobutylene, isoprene rubber, IIR) has a very low permeability rate and good electrical properties.

Heat resistance

- Up to approximately 121°C (250°F).

Cold flexibility

- Down to approximately -59°C (-75°F).

Chemical resistance

- Hot water and steam up to 121°C (250°F).
- Brake fluids with glycol base (Dot 3 & 4).
- Many acids (see Fluid Compatibility Tables in Section VII).
- Salt solutions.
- Polar solvents, (e.g. alcohols, ketones and esters).
- Poly-glycol based hydraulic fluids (HFC fluids) and phosphate-ester bases (HFD-R fluids).
- Silicone oil and grease.
- Ozone, aging and weather resistant.

Not compatible with:

- Mineral oil and grease.
- Fuels.
- Chlorinated hydrocarbons.

WARNING: These products can expose you to chemicals including carbon black (airborne and extracts), antimony trioxide, titanium dioxide, silica (crystalline), di(2-ethylhexyl) phthalate, ethylene thiourea, acrylonitrile, 1,3-butadiene, epichlorohydrin, toluenediisocyanate, tetrafluoroethylene, ethylbenzene, formaldehyde, furfuryl alcohol, glass fibers, methyl isobutyl ketone, nickel (metallic and compounds), lead and lead compounds which are known to the State of California to cause cancer; and 1,3-butadiene, epichlorohydrin, di(2-ethylhexyl)phthalate, di-isodecyl phthalate, ethylene thiourea, methyl isobutyl ketone, methanol, toluene, lead and lead compounds which are known to the State of California to cause birth defects and other reproductive harm. For more information go to www.P65Warnings.ca.gov.

2.2.6 Chloroprene Rubber (CR)

Chloroprene was the first synthetic rubber developed commercially and exhibits generally good ozone, aging and chemical resistance. It has good mechanical properties over a wide temperature range.

Heat resistance

- Up to approximately 121°C (250°F).

Cold flexibility

- Down to approximately -40°C (-40°F).

Chemical resistance

- Paraffin based mineral oil with low DPI, e.g. ASTM oil No. 1.
- Silicone oil and grease.
- Water and water solvents at low temperatures.
- Refrigerants
- Ammonia
- Carbon dioxide
- Improved ozone, weathering and aging resistance compared with nitrile.

Limited compatibility

- Naphthalene based mineral oil (IRM 902 and IRM 903 oils).
- Low molecular weight aliphatic hydrocarbons (propane, butane, fuel).
- Glycol based brake fluids.

Not compatible with:

- Aromatic hydrocarbons (benzene).
- Chlorinated hydrocarbons (trichloroethylene).
- Polar solvents (ketones, esters, ethers).

2.2.7 Fluorocarbon (FKM)

Fluorocarbon (FKM) has excellent resistance to high temperatures, ozone, oxygen, mineral oil, synthetic hydraulic fluids, fuels, aromatics and many organic solvents and chemicals. Low temperature resistance is normally not favorable and for static applications is limited to approximately -26°C (-15°F) although certain compounds are suitable down to -46°C (-50°F). Under dynamic conditions, the lowest service temperature is between -15°C and -18°C (5°F and 0°F).

Gas permeability is very low and similar to that of butyl rubber. Special FKM compounds exhibit an improved resistance to acids and fuels.

Heat resistance

- Up to 204°C (400°F) and higher temperatures with shorter life expectancy.

Cold flexibility

- Down to -26°C (-15°F) (some to -46°C (-50°F)).

Chemical resistance

- Mineral oil and grease, ASTM oil No. 1, and IRM 902 and IRM 903 oils.
- Non-flammable hydraulic fluids (HFD).
- Silicone oil and grease.

- Mineral and vegetable oil and grease.
- Aliphatic hydrocarbons (butane, propane, natural gas).
- Aromatic hydrocarbons (benzene, toluene).
- Chlorinated hydrocarbons (trichloroethylene and carbon tetrachloride).
- Gasoline (including high alcohol content).
- High vacuum.
- Very good ozone, weather and aging resistance.

Not compatible with:

- Glycol based brake fluids.
- Ammonia gas, amines, alkalis.
- Superheated steam.
- Low molecular weight organic acids (formic and acetic acids).

2.2.8 Fluorosilicone (FVMQ)

FVMQ contains trifluoropropyl groups next to the methyl groups. The mechanical and physical properties are very similar to VMQ. However, FVMQ offers improved fuel and mineral oil resistance but poor hot air resistance when compared with VMQ.

Heat resistance

- Up to 177°C (350°F) max.

Cold flexibility

- Down to approximately -73°C (-100°F).

Chemical resistance

- Aromatic mineral oils (IRM 903 oil).
- Fuels.
- Low molecular weight aromatic hydrocarbons (benzene, toluene).

2.2.9 Hydrogenated Nitrile (HNBR, HSN)

Hydrogenated nitrile is a synthetic polymer that results from the hydrogenation of nitrile rubber (NBR). Superior mechanical characteristics, particularly high strength, helps reduce extrusion and wear.

Heat resistance

- Up to 150°C (300°F)

Cold flexibility

- Down to approximately -48°C (-55°F)

Chemical resistance

- Aliphatic hydrocarbons.
- Vegetable and animal fats and oils.
- HFA, HFB and HFC hydraulic fluids.
- Dilute acids, bases and salt solutions at moderate temperatures.
- Water and steam up to 149°C (300°F).
- Ozone, aging and weathering.

Not compatible with:

- Chlorinated hydrocarbons.
- Polar solvents (ketones, esters and ethers).
- Strong acids.

WARNING: These products can expose you to chemicals including carbon black (airborne and extracts), antimony trioxide, titanium dioxide, silica (crystalline), di(2-ethylhexyl) phthalate, ethylene thiourea, acrylonitrile, 1,3-butadiene, epichlorohydrin, toluenediisocyanate, tetrafluoroethylene, ethylbenzene, formaldehyde, furfuryl alcohol, glass fibers, methyl isobutyl ketone, nickel (metallic and compounds), lead and lead compounds which are known to the State of California to cause cancer; and 1,3-butadiene, epichlorohydrin, di(2-ethylhexyl)phthalate, di-isodecyl phthalate, ethylene thiourea, methyl isobutyl ketone, methanol, toluene, lead and lead compounds which are known to the State of California to cause birth defects and other reproductive harm. For more information go to www.P65Warnings.ca.gov.

2.2.10 Perfluoroelastomer (FFKM)

Perfluoroelastomer (FFKM) currently offers the highest operating temperature range, the most comprehensive chemical compatibility, and the lowest off-gassing and extractable levels of any rubber material. Parker's proprietary formulations deliver an extreme performance spectrum that make them ideal for use in critical applications like semiconductor chip manufacturing, jet engines and chemical processing equipment.

Heat resistance

- Up to 320°C (608°F).

Cold flexibility

- -18°C to -26°C (0°F to -15°F).

Chemical resistance

- Aliphatic and aromatic hydrocarbons.
- Chlorinated hydrocarbons.
- Polar solvents (ketones, esters, ethers).
- Inorganic and organic acids.
- Water and steam.
- High vacuum with minimal loss in weight.

Not compatible with:

- Fluorinated refrigerants (R11, 12, 13, 113, 114, etc.)
- Perfluorinated lubricants (PFPE)

2.2.11 Polyacrylate (ACM)

ACM (acrylic rubber) has good resistance to mineral oil, oxygen and ozone. Water compatibility and cold flexibility of ACM are significantly worse than with nitrile.

Heat resistance

- Up to approximately 177°C (350°F).

Cold flexibility

- Down to approximately -21°C (-5°F).

Chemical resistance

- Mineral oil (engine, gear box, ATF oil).
- Ozone, weather and aging.

Not compatible with:

- Glycol based brake fluid (Dot 3 and 4).
- Aromatics and chlorinated hydrocarbons.
- Hot water, steam.
- Acids, alkalis, amines.

2.2.12 Polyurethane (AU, EU)

Polyurethane elastomers, as a class, have excellent wear resistance, high tensile strength and high elasticity in comparison with any other elastomers. Permeability is good and comparable with butyl.

Heat resistance

- Up to approximately 82°C (180°F).

Cold flexibility

- Down to approximately -40°C (-40°F).

Chemical resistance

- Pure aliphatic hydrocarbons (propane, butane).
- Mineral oil and grease.
- Silicone oil and grease.
- Water up to 50°C (125°F).

Not compatible with:

- Ketones, esters, ethers, alcohols, glycols.
- Hot water, steam, alkalis, amines, acids.

2.2.13 Silicone Rubber (Q, MQ, VMQ, PVMQ)

Silicones have good ozone and weather resistance as well as good insulating and physiologically neutral properties. However, silicone elastomers as a group, have relatively low tensile strength, poor tear strength and little wear resistance.

Heat resistance

- Up to approximately 204°C (400°F) special compounds up to 260°C (500°F).

Cold flexibility

- Down to approximately -54°C (-65°F) special compounds down to -115°C (-175°F).

Chemical resistance

- Animal and vegetable oil and grease.
- High molecular weight chlorinated aromatic hydrocarbons (including flame-resistant insulators, and coolant for transformers).
- Moderate water resistance.
- Diluted salt solutions.
- Ozone, aging and weather.

Not compatible with:

- Superheated water steam over 121°C (250°F).
- Acids and alkalis.
- Low molecular weight chlorinated hydrocarbons (trichloroethylene).
- Hydrocarbon based fuels.
- Aromatic hydrocarbons (benzene, toluene).
- Low molecular weight silicone oils.

2.2.14 Tetrafluoroethylene-Propylene (AFLAS)

This elastomer is a copolymer of tetrafluoroethylene (TFE) and propylene. Its chemical resistance is excellent across a wide range of aggressive media.

Heat resistance

- Up to approximately 232°C (450°F).

Cold flexibility

- Down to approximately -9°C (15°F).

Compatible with

- Bases.
- Phosphate Esters.
- Amines.
- Engine Oils.
- Steam and hot water.
- Pulp and paper liquors.

Not compatible with:

- Aromatic Fuels.
- Ketones.
- Chlorinated hydrocarbons.



WARNING: These products can expose you to chemicals including carbon black (airborne and extracts), antimony trioxide, titanium dioxide, silica (crystalline), di(2-ethylhexyl) phthalate, ethylene thiourea, acrylonitrile, 1,3-butadiene, epichlorohydrin, toluenediisocyanate, tetrafluoroethylene, ethylbenzene, formaldehyde, furfuryl alcohol, glass fibers, methyl isobutyl ketone, nickel (metallic and compounds), lead and lead compounds which are known to the State of California to cause cancer; and 1,3-butadiene, epichlorohydrin, di(2-ethylhexyl)phthalate, di-isodecyl phthalate, ethylene thiourea, methyl isobutyl ketone, methanol, toluene, lead and lead compounds which are known to the State of California to cause birth defects and other reproductive harm. For more information go to www.P65Warnings.ca.gov.

2.3 Compound Selection and Numbering Systems

The base elastomer and the hardness of the *finished* product are the main factors which enable a given compound to resist heat, chemical and other physical influences.

The Parker compound code contains all the essential information needed to identify the polymer family as well as the special property description and hardness.

In the Type I numbering system, the base polymer of the compound is identified by the prefix letter:

- A = Polyacrylate
- B = Butyl or chlorobutyl
- C = Neoprene
- E = Ethylene-propylene or ethylene propylene diene
- F = Parofluor Ultra
- H = Hifluor
- K = Hydrogenated nitrile
- L = Fluorosilicone
- N = Acrylonitrile butadiene (nitrile), hydrogenated nitrile and carboxylated nitrile
- P = Polyurethane
- S = Silicone
- V = Fluorocarbon, AFLAS, Parofluor and Hifluor
- Z = Exotic or specialty blends

In the Type II numbering system, the special property description is identified by a second letter:

- A = General purpose
- B = Low compression set
- E = Ethylene acrylate
- F = Fuel resistant or fully fluorinated
- G = High fluorine content
- J = NSF/FDA/WRAS approvals
- L = Internally lubed
- M = MIL/AMS approvals
- P = Low temperature or AFLAS
- W = Non-black compound
- S = Carboxylated

The shore hardness range of a compound is indicated by the suffix numbers, e.g. “70” means that the material’s hardness is 70±5 Shore A.

The individual sequential compound number is shown between the suffix and the prefix.

Type I Example: N0674-70 where

- N = Acrylonitrile-butadiene or simply nitrile
- 0674 = Individual sequential compound identifier
- 70 = Nominal Shore A hardness

Type II Example: NA151-70 where

- N = Acrylonitrile-butadiene or simply nitrile
- A = General purpose
- 151 = Individual sequential compound identifier
- 70 = Nominal Shore A hardness

2.3.1 Selection of Base Polymer

System operating temperatures and compatibility with the media to be sealed are the two most important parameters which must be considered when selecting a base polymer. Only when these two factors are identified (including any lubricants and potential cleaning fluids), can a reliable recommendation be given concerning selection of the proper elastomer base. For the seal designed, a compromise often has to be made between specifying high quality, sealing grade materials and cheaper commercial products (which usually contain less base polymer and more inexpensive fillers).

The application temperatures given in Figure 2-3 refer to long-term exposure to non-aggressive media. At higher temperatures, new crosslink sites may be formed between the polymer chains and lead to a loss of seal flexibility. The stiffness in the polymer chains may be observed as excessive compression set in highly filled (loaded) compounds. This condition prevents an O-ring cross-section from returning to its original, pre-compressed shape after deformation forces are removed. During compression, a seal changes its original shape to effect a seal and over time, and with excessive temperature, elastic memory loss in the elastomer seal element can cause leakage. Exceeding the normal maximum temperature limit for a given compound always results in reduced service life.

Practically all elastomers undergo a physical or chemical change when in contact with a sealed medium. The degree of change depends on the chemistry of the medium and on the system temperature. An aggressive medium becomes more active with increasing temperature. Physical changes are caused by three mechanisms which can work concurrently when:

- a. The elastomer absorbs a medium.
- b. Plasticizers and other components of the compound are dissolved and extracted or leached out by the media.
- c. Chemical reactions between the elastomer and the sealed medium.

The result is often volume change, i.e. swelling or shrinkage of the elastomer seal. The degree of volume change depends on the type of medium, molecular structure of the rubber compound, system temperature, geometrical seal shape (material thickness), and the stressed condition of the rubber part (compression or stretch). When deformed and exposed to a medium, rubber, when confined in a gland, swells significantly less than in free state (up to 50%) due to a number of factors including lessened surface area in contact with the medium.

The limit of permissible volume change varies with the application. For static seals, a volume change of 25% to 30% can be tolerated. Swelling leads to some deterioration of the mechanical properties, and in particular, those properties which improve extrusion resistance.

In dynamic applications, swelling leads to increased friction and a higher wear rate. Therefore, a maximum swell of 10% should generally not be exceeded. Shrinkage should also be avoided because the resulting loss of compressive force will increase the risk of leakage.

WARNING: These products can expose you to chemicals including carbon black (airborne and extracts), antimony trioxide, titanium dioxide, silica (crystalline), di(2-ethylhexyl) phthalate, ethylene thiourea, acrylonitrile, 1,3-butadiene, epichlorohydrin, toluenediisocyanate, tetrafluoroethylene, ethylbenzene, formaldehyde, furfuryl alcohol, glass fibers, methyl isobutyl ketone, nickel (metallic and compounds), lead and lead compounds which are known to the State of California to cause cancer; and 1,3-butadiene, epichlorohydrin, di(2-ethylhexyl)phthalate, di-isodecyl phthalate, ethylene thiourea, methyl isobutyl ketone, methanol, toluene, lead and lead compounds which are known to the State of California to cause birth defects and other reproductive harm. For more information go to www.P65Warnings.ca.gov.

The extraction of plasticizer from a seal material is sometimes compensated for by partial absorption of the contact medium. This situation however, can still lead to unexpected shrinkage and resultant leakage when an elastomer dries out and the absorbed fluids evaporate.

A chemical reaction between sealed or excluded medium and the elastomer can bring about structural changes in the form of further crosslinking or degrading. The smallest chemical change in an elastomer can lead to significant changes in physical properties, such as embrittlement.

The suitability of an elastomer for a specific application can be established only when the properties of both the medium and the elastomer are known under typical **working** conditions. If a particular seal material suits a medium, it is referred to as being “compatible” with that medium. See Table 2-2 for a comparison of the properties of commonly used elastomers.

2.4 Physical and Chemical Characteristics

In addition to the basic elastomer descriptions, it is helpful have more information on the important physical and chemical properties of various elastomer compounds. This information is needed to provide a clearer picture of how physical and chemical properties interact and affect the proper selection of an effective seal material. Among the more basic physical properties that have to be considered are:

2.4.1 Resistance to Fluid

As used throughout this handbook, the term “fluid” denotes the substance retained by the seal. It may be a solid, a liquid, a gas, a vapor or a mixture of all. (The term “medium” — plural “media” — is often used with this same meaning intended.)

The chemical effect of the fluid on the seal is of prime importance. The fluid must not alter the operational characteristics or reduce the life expectancy of the seal significantly. Excessive chemical deterioration of the seal must be avoided. It is easy, however, to be misled on this

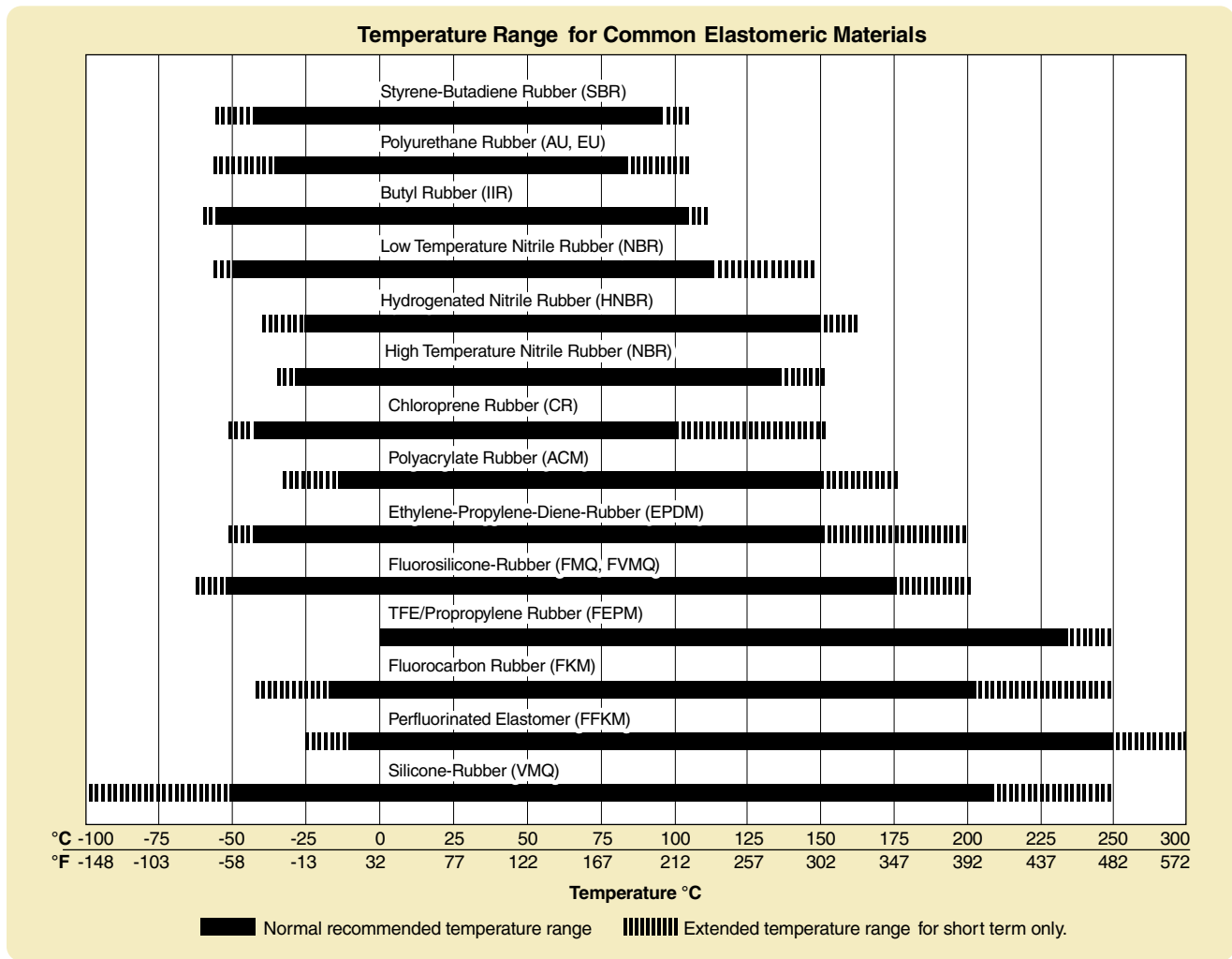

Figure 2-3: Temperature Range for Common Elastomeric Materials

WARNING: These products can expose you to chemicals including carbon black (airborne and extracts), antimony trioxide, titanium dioxide, silica (crystalline), di(2-ethylhexyl) phthalate, ethylene thiourea, acrylonitrile, 1,3-butadiene, epichlorohydrin, toluenediisocyanate, tetrafluoroethylene, ethylbenzene, formaldehyde, furfuryl alcohol, glass fibers, methyl isobutyl ketone, nickel (metallic and compounds), lead and lead compounds which are known to the State of California to cause cancer; and 1,3-butadiene, epichlorohydrin, di(2-ethylhexyl)phthalate, di-isodecyl phthalate, ethylene thiourea, methyl isobutyl ketone, methanol, toluene, lead and lead compounds which are known to the State of California to cause birth defects and other reproductive harm. For more information go to www.P65Warnings.ca.gov.

point. A significant amount of volume shrinkage usually results in premature leakage of any O-ring seal, whether static or dynamic. On the other hand, a compound that swells excessively in a fluid, or develops a large increase or decrease in hardness, tensile strength, or elongation, will often continue to serve well for a long time as a static seal in spite of such undesirable conditions.

2.4.2 Hardness

Throughout the seal industry, the Shore A type durometer scale, manufactured by a variety of manufacturers, is the standard instrument used to measure the hardness of most rubber compounds. It should be noted that there are other hardness scales used to describe elastomers (B, C, D, DO, O, OO) but these are typically not used by the rubber seal industry.

The durometer has a calibrated spring which forces an indenter point into the test specimen against the resistance of the rubber. The indicating scale reads the hardness of the rubber. If there is no penetration, the scale will read 100, as on a flat glass or steel surface. (For specimens that are too thin or provide too small an area for accurate durometer readings, Micro Hardness Testing is recommended).

In the O-ring industry, another hardness scale is used due to the curved surface of the O-ring cross-section causing problems with accurately reading Shore A. The scale is IRHD (International Rubber Hardness Degrees). The size and shape of the indenter used in IRHD readings is much smaller, thus allowing for more accurate measurements on curved surfaces such as an O-ring cross-section. Unfortunately, there is not a direct correlation between the readings of Shore A and IRHD Scales.

Comparison of Properties of Commonly Used Elastomers
 (P = Poor - F = Fair - G = Good - E = Excellent)

Elastomer Type (Polymer)	Parker Compound Prefix Letter	Abrasion Resistance	Acid Resistance	Chemical Resistance	Cold Resistance	Dynamic Properties	Electrical Properties	Flame Resistance	Heat Resistance	Impermeability	Oil Resistance	Ozone Resistance	Set Resistance	Tear Resistance	Tensile Strength	Water/Steam Resistance	Weather Resistance
AFLAS (TFE/Prop)	V	GE	E	E	P	G	E	E	E	G	E	E	PF	PF	FG	GE	E
Butadiene		E	FG	FG	G	F	G	P	F	F	P	P	G	GE	E	FG	F
Butyl	B	FG	G	E	G	F	G	P	G	E	P	GE	FG	G	G	G	GE
Chlorinated Polyethylene		G	F	FG	PF	G	G	GE	G	G	FG	E	F	FG	G	F	E
Chlorosulfonated Polyethylene		G	G	E	FG	F	F	G	G	G	F	E	F	G	F	F	E
Epichlorohydrin	Y	G	FG	G	GE	G	F	FG	FG	GE	E	E	PF	G	G	F	E
Ethylene Acrylic	A	F	F	FG	G	F	F	P	E	E	F	E	G	F	G	PF	E
Ethylene Propylene	E	GE	G	E	GE	GE	G	P	G	G	P	E	GE	GE	GE	E	E
Fluorocarbon	V	G	E	E	PF	GE	F	E	E	G	E	E	E	F	GE	F	E
Fluorosilicone	L	P	FG	E	GE	P	E	G	E	P	G	E	G	P	F	F	E
Isoprene		E	FG	FG	G	F	G	P	F	F	P	P	G	GE	E	FG	F
Natural Rubber		E	FG	FG	G	E	G	P	F	F	P	P	G	GE	E	FG	F
Neoprene	C	G	FG	FG	FG	F	F	G	G	G	FG	GE	F	FG	G	F	E
HNBR	N, K	G	E	FG	G	GE	F	P	E	G	E	G	GE	FG	E	E	G
Nitrile or Buna N	N	G	F	FG	G	GE	F	P	G	G	E	P	GE	FG	GE	FG	F
Perfluorinated Fluoroelastomer	V, F	P	E	E	PF	F	E	E	E	G	E	E	G	PF	FG	GE	E
Polyacrylate	A	G	P	P	P	F	F	P	E	E	E	E	F	FG	F	P	E
Polysulfide		P	P	G	G	F	F	P	P	E	E	E	P	P	F	F	E
Polyurethane	P	E	P	FG	G	E	FG	P	F	G	G	E	F	GE	E	P	E
SBR or Buna S		G	F	FG	G	G	G	P	FG	F	P	P	G	FG	GE	FG	F
Silicone	S	P	FG	GE	E	P	E	F	E	P	FG	E	GE	P	P	F	E

Table 2-2: Comparison of Properties of Commonly Used Elastomers

WARNING: These products can expose you to chemicals including carbon black (airborne and extracts), antimony trioxide, titanium dioxide, silica (crystalline), di(2-ethylhexyl) phthalate, ethylene thiourea, acrylonitrile, 1,3-butadiene, epichlorohydrin, toluenediisocyanate, tetrafluoroethylene, ethylbenzene, formaldehyde, furfuryl alcohol, glass fibers, methyl isobutyl ketone, nickel (metallic and compounds), lead and lead compounds which are known to the State of California to cause cancer; and 1,3-butadiene, epichlorohydrin, di(2-ethylhexyl)phthalate, di-isodecyl phthalate, ethylene thiourea, methyl isobutyl ketone, methanol, toluene, lead and lead compounds which are known to the State of California to cause birth defects and other reproductive harm. For more information go to www.P65Warnings.ca.gov.

Softer sealing materials, with lower hardness readings, will flow more easily into the microfine grooves and imperfections of the mating parts (the gland, bore, rod or seal flanges). This is particularly important in low-pressure seals because they are not activated by fluid pressure. Conversely, the harder materials offer greater resistance to extrusion. Referring back to the O-ring seal diagrams, Figures 1-4 through 1-7, it can be seen that a harder O-ring will have greater resistance to extrusion into the narrow gap between the piston and bore. There are certain applications in which the compressive load available for assembly is limited. In these situations, Figures 2-4 through 2-8 are helpful, providing compression load requirements for O-rings of different hardnesses, for each of the five standard O-ring cross-sections.

In dynamic applications, the hardness of the O-ring is doubly important because it also affects both breakout and running friction. Although a harder compound will, in general, have a lower coefficient of friction than a softer material, the actual running and breakout friction values are actually higher because the compressive load required to achieve the proper squeeze and force the harder material into a given O-ring cavity is so much greater.

For most applications, compounds having a Shore A durometer hardness of 70 to 80 is the most suitable compromise. This is particularly true of dynamic applications where 90 durometer or harder compounds often allow a few drops of fluid to pass with each cycle, and 50 durometer compounds tend to abrade, wear, and extrude very quickly.

Normally durometer hardness is referred to in increments of five or ten, as **60** durometer, **75** durometer, etc. — not as **62** durometer, **66** durometer or **73** durometer. This practice is based on:

- (1) The fact that durometer is generally called out in specifications with a tolerance of ± 5 (i.e., 65 ± 5 , 70 ± 5 , 90 ± 5);
- (2) The inherent minor variance from batch to batch of a given rubber compound due to slight differences in raw materials and processing techniques; and
- (3) The human variance encountered in reading durometer hardness. On a 70-durometer stock, for example, one person might read 69 and another 71. This small difference is to be expected and is considered to be within acceptable experimental error and the accuracy of the testing equipment.

2.4.3 Toughness

Toughness is not a measured property or parameter but rather a qualitative term frequently used to summarize the combination of resistance to physical forces other than chemical action. It is used as a relative term in practice. The following six terms (paragraphs 2.4.4 through 2.4.9) are major indicators of, and describe the “toughness” of a compound.

2.4.4 Tensile Strength

Tensile strength is measured as the psi (pounds per square inch) or MPa (Mega Pascals) required to rupture a specimen of a given elastomer material when stressed. Tensile strength is one quality assurance measurement used to insure compound uniformity. It is also useful as an indication of deterioration of the compound after it has been in contact with a fluid for long periods. If fluid contact results in only a small reduction in tensile strength, seal life may still be relatively long, yet if a large reduction of tensile strength occurs, seal life may be relatively short. Exceptions to this rule do occur. Tensile strength is **not** a proper indication of resistance to extrusion, nor is it ordinarily used in design calculations. However, in dynamic applications a minimum of 1,000 psi (7 MPa) is normally necessary to assure good strength characteristics required for long-term sealability and wear resistance in moving systems.

2.4.5 Elongation

Elongation is defined as the increase in length, expressed numerically, as a percent of initial length. It is generally reported as ultimate elongation, the increase over the original dimension at break. This property primarily determines the stretch which can be tolerated during the installation of an O-ring. Elongation increases in importance as the diameters of a gland become smaller. It is also a measure of the ability of a compound to recover from peak overload, or a force localized in one small area of a seal, when considered in conjunction with tensile strength. An adverse change in the elongation of a compound after exposure to a fluid is a definite sign of degradation of the material. Elongation, like tensile strength, is used throughout the industry as a quality assurance measure on production batches of elastomer materials.

2.4.6 O-Ring Compression Force

O-ring compression force is the force required to compress an O-ring the amount necessary to maintain an adequate sealing line of contact. See Table 2-3 and Figures 2-4 through 2-8. It is very important in some applications, particularly in face-type seals where the available compression load is limited. The factors that influence compression force for a given application, and a method of finding its approximate magnitude are explained in Section III, O-Ring Applications.

O-Ring Compression Force

Durometer Range	Diameter	Compression Load
Less than normal	Less than 25.4 mm (1")	Middle third of range
Less than normal	Over 25.4 mm (1")	Lower half of range
Over normal	Less than 25.4 mm (1")	Upper third of range
Over normal	Over 25.4 mm (1")	Upper half of range

Table 2-3: O-Ring Compression Force



WARNING: These products can expose you to chemicals including carbon black (airborne and extracts), antimony trioxide, titanium dioxide, silica (crystalline), di(2-ethylhexyl) phthalate, ethylene thiourea, acrylonitrile, 1,3-butadiene, epichlorohydrin, toluenediisocyanate, tetrafluoroethylene, ethylbenzene, formaldehyde, furfuryl alcohol, glass fibers, methyl isobutyl ketone, nickel (metallic and compounds), lead and lead compounds which are known to the State of California to cause cancer; and 1,3-butadiene, epichlorohydrin, di(2-ethylhexyl)phthalate, di-isodecyl phthalate, ethylene thiourea, methyl isobutyl ketone, methanol, toluene, lead and lead compounds which are known to the State of California to cause birth defects and other reproductive harm. For more information go to www.P65Warnings.ca.gov.

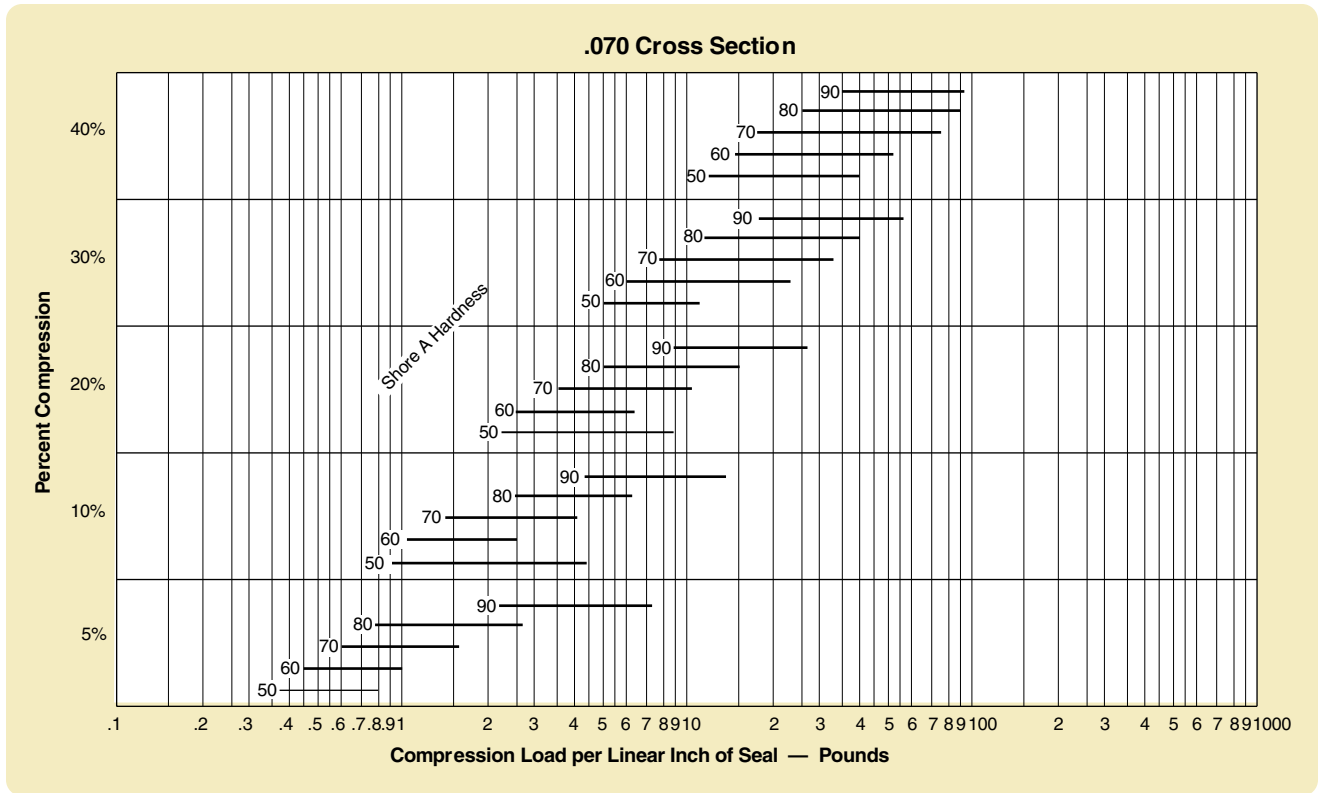

Figure 2-4: .070 Cross Section

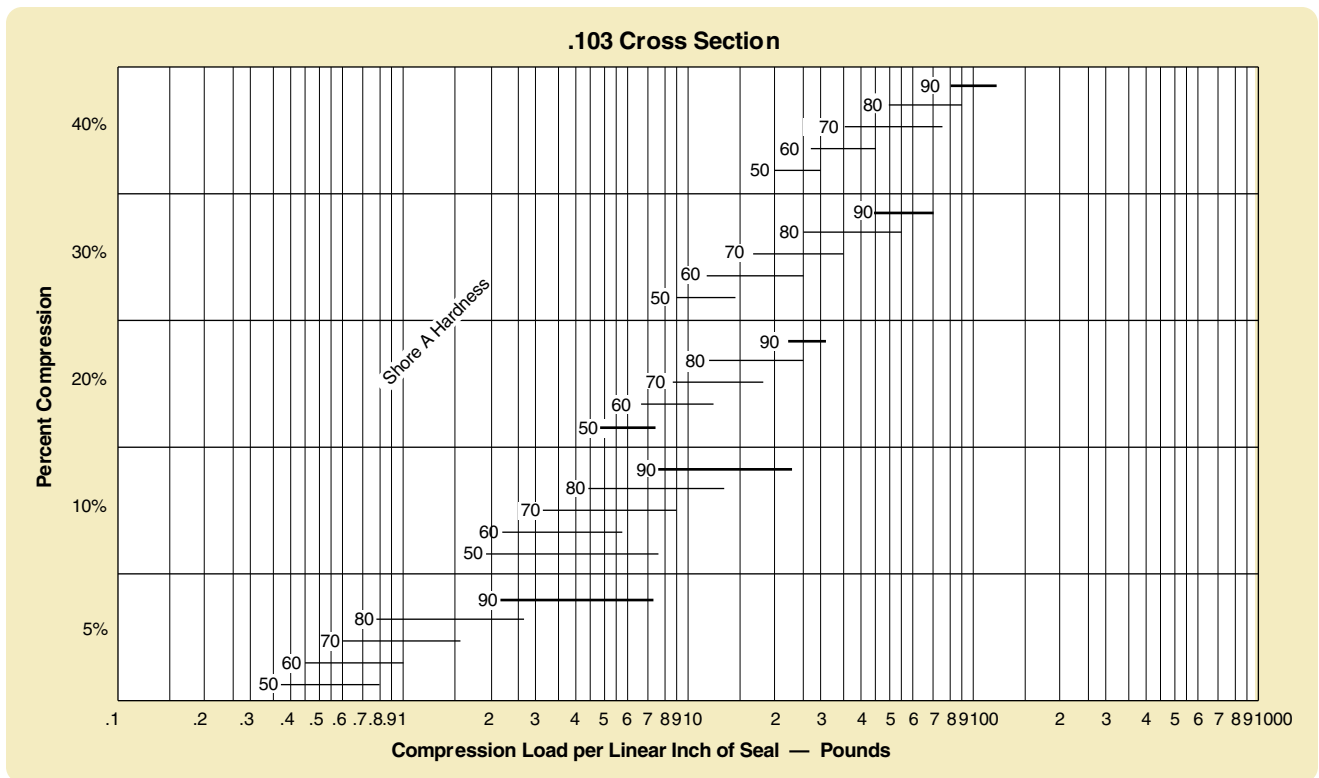

Figure 2-5: .103 Cross Section

WARNING: These products can expose you to chemicals including carbon black (airborne and extracts), antimony trioxide, titanium dioxide, silica (crystalline), di(2-ethylhexyl) phthalate, ethylene thiourea, acrylonitrile, 1,3-butadiene, epichlorohydrin, toluenediisocyanate, tetrafluoroethylene, ethylbenzene, formaldehyde, furfuryl alcohol, glass fibers, methyl isobutyl ketone, nickel (metallic and compounds), lead and lead compounds which are known to the State of California to cause cancer; and 1,3-butadiene, epichlorohydrin, di(2-ethylhexyl)phthalate, di-isodecyl phthalate, ethylene thiourea, methyl isobutyl ketone, methanol, toluene, lead and lead compounds which are known to the State of California to cause birth defects and other reproductive harm. For more information go to www.P65Warnings.ca.gov.

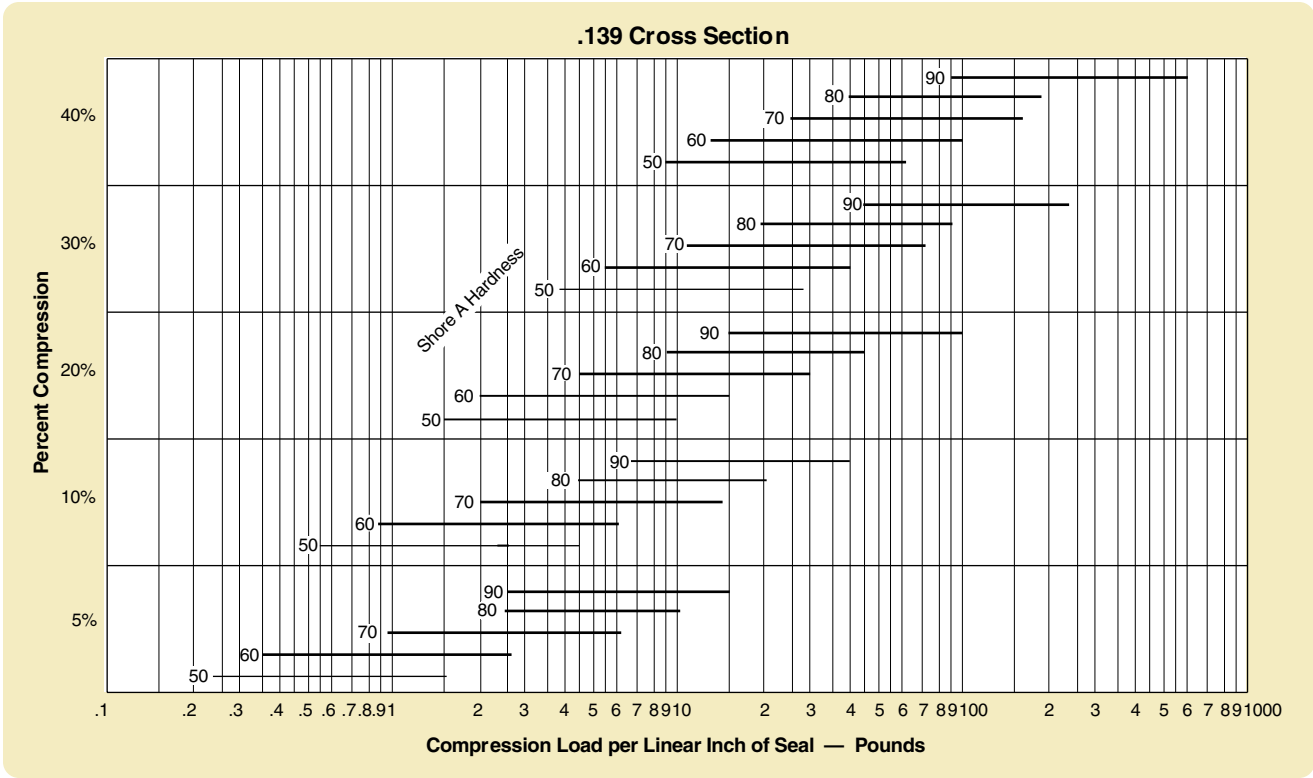

Figure 2-6: .139 Cross Section

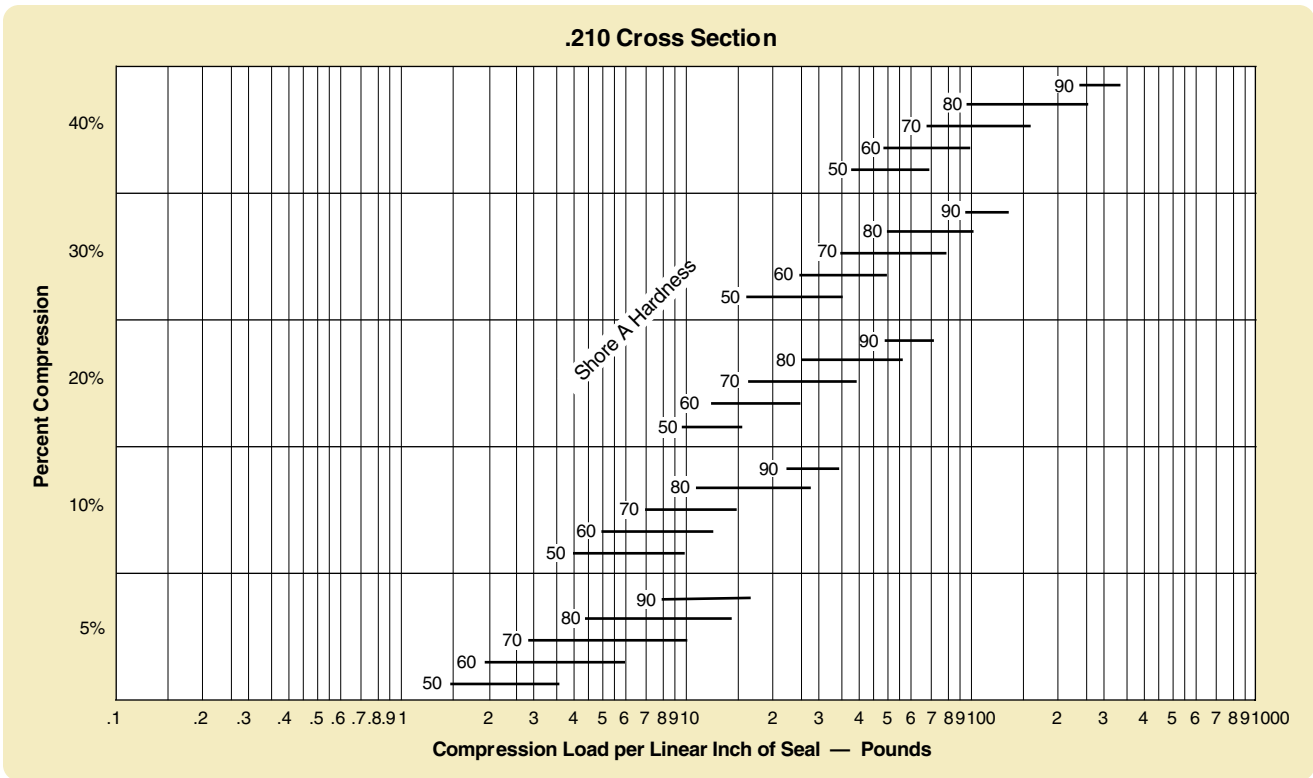

Figure 2-7: .210 Cross Section

WARNING: These products can expose you to chemicals including carbon black (airborne and extracts), antimony trioxide, titanium dioxide, silica (crystalline), di(2-ethylhexyl) phthalate, ethylene thiourea, acrylonitrile, 1,3-butadiene, epichlorohydrin, toluenediisocyanate, tetrafluoroethylene, ethylbenzene, formaldehyde, furfuryl alcohol, glass fibers, methyl isobutyl ketone, nickel (metallic and compounds), lead and lead compounds which are known to the State of California to cause cancer; and 1,3-butadiene, epichlorohydrin, di(2-ethylhexyl)phthalate, di-isodecyl phthalate, ethylene thiourea, methyl isobutyl ketone, methanol, toluene, lead and lead compounds which are known to the State of California to cause birth defects and other reproductive harm. For more information go to www.P65Warnings.ca.gov.

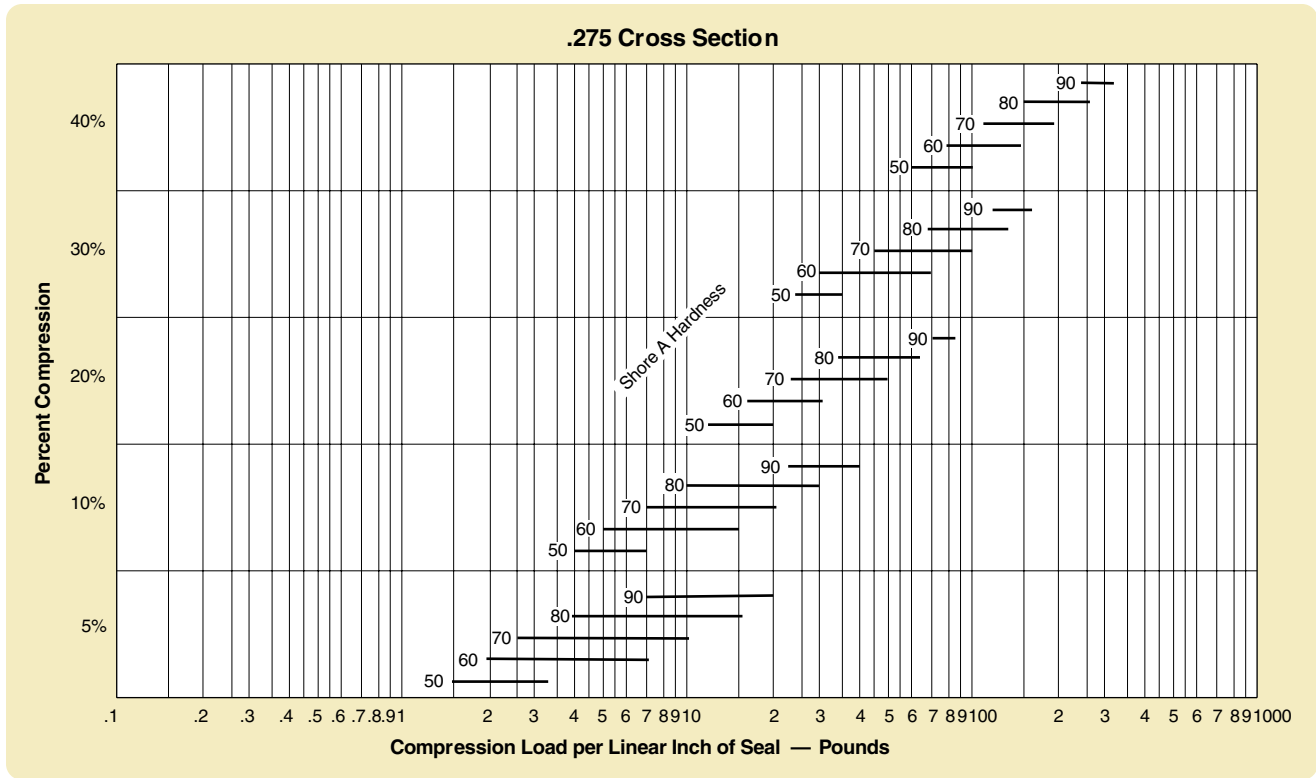

Figure 2-8: .275 Cross Section

2.4.7 Modulus

Modulus, as used in rubber terminology, refers to stress at a predetermined elongation, usually 100%. It is expressed in pounds per square inch (psi) or MPa (Mega Pascals). This is actually the elastic modulus of the material.

The higher the modulus of a compound, the more apt it is to recover from peak overload or localized force, and the better its resistance to extrusion. Modulus normally increases with an increase in hardness. It is probably the best overall indicator of the toughness of a given compound, all other factors being equal.

2.4.8 Tear Resistance

Tear strength is relatively low for most compounds. However, if it is extremely low (less than 100 lbs./in.) (17.5 kn/m), there is increased danger of nicking or cutting the O-ring during assembly, especially if it must pass over ports, sharp edges or burrs. Compounds with poor tear resistance will fail quickly under further flexing or stress once a crack is started. In dynamic seal applications, inferior tear strength of a compound is also indicative of poor abrasion resistance which may lead to premature wear and early failure of the seal. Usually however, this property need not be considered for static applications.

2.4.9 Abrasion Resistance

Abrasion resistance is a general term that indicates the wear resistance of a compound. Where “tear resistance” essentially concerns cutting or otherwise rupturing the surface, “abrasion resistance” concerns scraping or rubbing of the surface. This is of major importance for dynamic seal materials. Only certain elastomers are recommended for dynamic O-ring service where moving parts actually contact the seal material. Harder compounds, up to 90 durometer, are normally more resistant to abrasion than softer compounds. Of course, as with all sealing compromises, abrasion resistance must be considered in conjunction with other physical and chemical requirements.

2.4.10 Volume Change

Volume change is the increase or decrease of the volume of an elastomer after it has been in contact with a fluid, measured in percent (%).

Swell or increase in volume is almost always accompanied by a decrease in hardness. As might be surmised, excessive swell will result in marked softening of the rubber. This condition will lead to reduced abrasion and tear resistance, and may permit extrusion of the seal under high pressure.

For static O-ring applications volume swell up to 30% can usually be tolerated. For dynamic applications, 10 or 15% swell is a reasonable maximum unless special provisions are made in the gland design itself. This is a rule-of-thumb and there will be occasional exceptions to the rule.

WARNING: These products can expose you to chemicals including carbon black (airborne and extracts), antimony trioxide, titanium dioxide, silica (crystalline), di(2-ethylhexyl) phthalate, ethylene thiourea, acrylonitrile, 1,3-butadiene, epichlorohydrin, toluenediisocyanate, tetrafluoroethylene, ethylbenzene, formaldehyde, furfuryl alcohol, glass fibers, methyl isobutyl ketone, nickel (metallic and compounds), lead and lead compounds which are known to the State of California to cause cancer; and 1,3-butadiene, epichlorohydrin, di(2-ethylhexyl)phthalate, di-isodecyl phthalate, ethylene thiourea, methyl isobutyl ketone, methanol, toluene, lead and lead compounds which are known to the State of California to cause birth defects and other reproductive harm. For more information go to www.P65Warnings.ca.gov.

Swell may actually augment seal effectiveness under some circumstances. For instance, (1) swell may compensate for compression set. If a seal relaxes 15% and swells 20%, the relaxation (compression set) tends to be canceled by the swell (see Table 2-4), (2) absorbed fluid may have somewhat the same effect on a compound as the addition of plasticizers, softening and thus providing more seal flexibility at the low temperature end of its operating range. These “potential” good effects however, should not be relied upon when choosing a compound for an application. Awareness of these facts is of interest as they can and frequently do contribute to enhanced seal performance. The amount of volume swell after long-term immersion — stabilized volume — is seldom reported because it takes several readings to identify. The usual 70-hour ASTM immersion test will indicate a swelling effect, whereas a long-term test shows shrinkage. Thus swell indicated by short-term testing may only be an interim condition.

Shrinkage or decrease in volume is usually accompanied by an increase in hardness. Also, just as swell compensates for compression set, shrinkage will intensify the compression set effect causing the seal to pull away from sealing surfaces, thus providing a leak path. It is apparent then, that shrinkage is far more critical than swell. More than 3 or 4% shrinkage can be serious for dynamic seals. In some instances, fluids may extract plasticizers, causing the seal to shrink when the fluid is temporarily removed and the seal is allowed to dry out. Such shrinkage may or may not be serious; depending on its magnitude, gland design, and the degree of leakage tolerable *before* the seal re-swells and regains its sealing line of contact. However, even if the seal does re-swell there

is the danger that it may not properly reseal itself. If any shrinkage is a possibility in an application, it must be considered thoroughly and carefully.

2.4.11 Compression Set

Compression set is generally determined in air aging and reported as the percent of deflection by which the elastomer fails to recover after a fixed time under specified squeeze and temperature. Zero percent (0%) indicates no relaxation has occurred whereas 100% indicates total relaxation; the seal just contacts mating surfaces but no longer exerts a force against those surfaces.

Compression set may also be stated as a percent of original thickness. However, percent of original deflection is more common. See Figure 2-9.

Although it is generally desirable to have low compression set properties in a seal material, this is not so critical as it might appear from a practical design standpoint, because of actual service variables. It is easy to go overboard on this property from a theoretical standpoint. Remember that a good balance of all physical properties is usually necessary for optimum seal performance. This is the eternal sealing compromise the seal designer always faces.

For instance, a seal may continue to seal after taking a 100% compression set provided temperature and system pressure remain steady and no motion or force causes a break in the line of seal contact. Also, as mentioned previously, swelling caused by contact with the service fluid may compensate for compression set. Table 2-4 shows the results of a laboratory test that illustrates this phenomenon.

Note that in air and in the fluid that caused slight shrinkage, the compound took a set of approximately 20 to 25%. In the fluid that caused a 20% swell, there was no measurable compression set. The condition most to be feared is the combination of high compression set and shrinkage. This will always lead to seal failure unless exceptionally high squeeze is employed. See Figures 2-10 through 2-17.

Compression Set vs. Volume Change

Parker Compound: Butyl Time: 168 hrs.	Temperature: 74°C (165°F) Deflection used: 25%		
	Air	Fluorolube	Fluoroester
Volume Change %	0	+19.5	-0.4
Set % of Original Deflection	25.4	0	20.7

Table 2-4: Compression Set vs. Volume Change

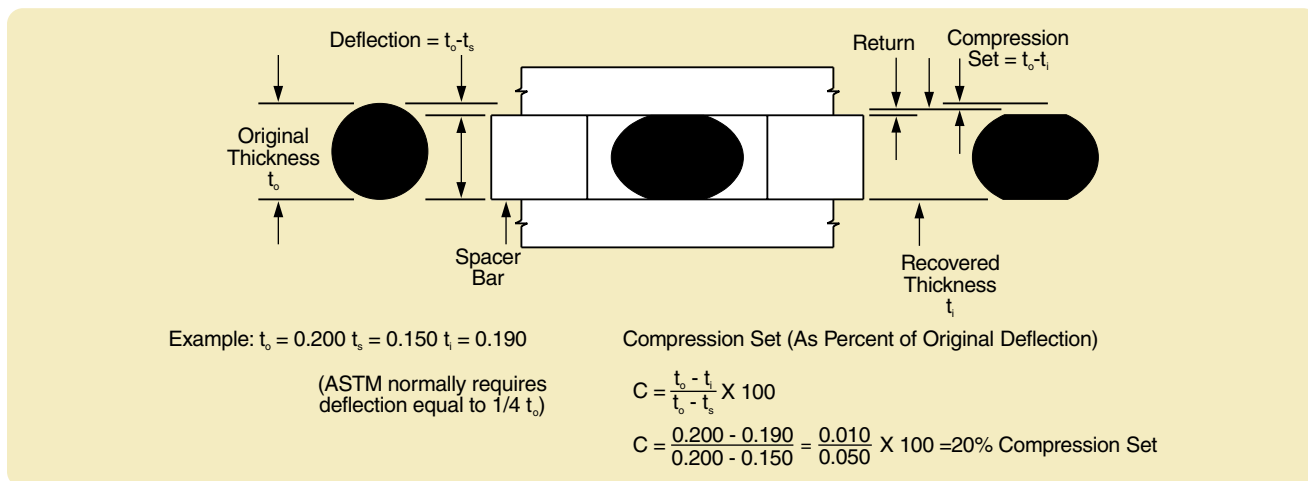

Figure 2-9: Compression Set

WARNING: These products can expose you to chemicals including carbon black (airborne and extracts), antimony trioxide, titanium dioxide, silica (crystalline), di(2-ethylhexyl) phthalate, ethylene thiourea, acrylonitrile, 1,3-butadiene, epichlorohydrin, toluenediisocyanate, tetrafluoroethylene, ethylbenzene, formaldehyde, furfuryl alcohol, glass fibers, methyl isobutyl ketone, nickel (metallic and compounds), lead and lead compounds which are known to the State of California to cause cancer; and 1,3-butadiene, epichlorohydrin, di(2-ethylhexyl)phthalate, di-isodecyl phthalate, ethylene thiourea, methyl isobutyl ketone, methanol, toluene, lead and lead compounds which are known to the State of California to cause birth defects and other reproductive harm. For more information go to www.P65Warnings.ca.gov.

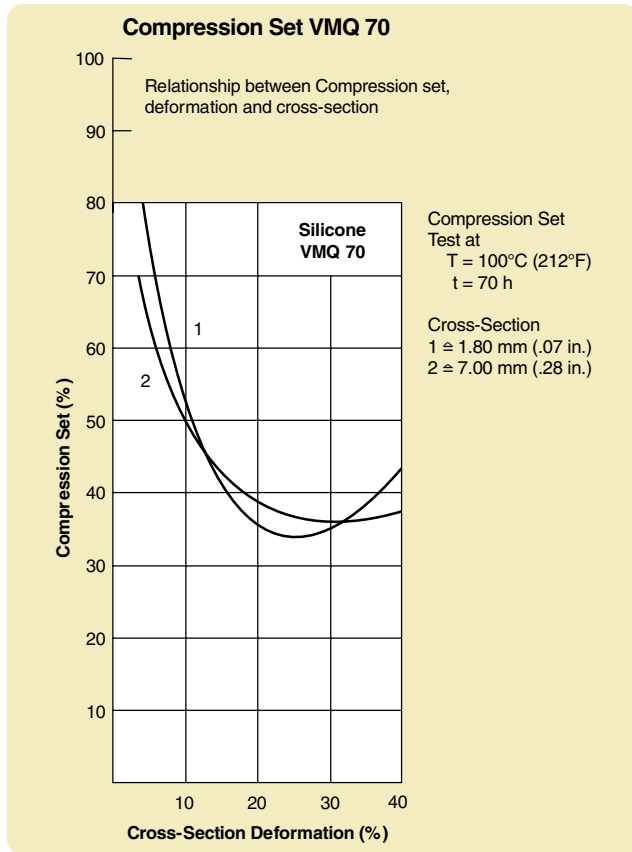

Figure 2-10: Compression Set VMQ 70

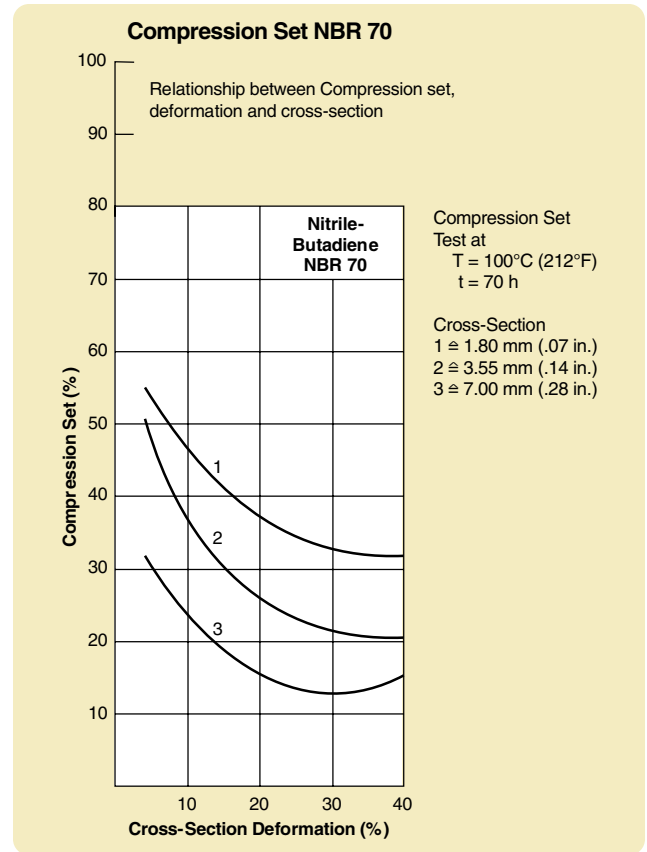

Figure 2-11: Compression Set NBR 70

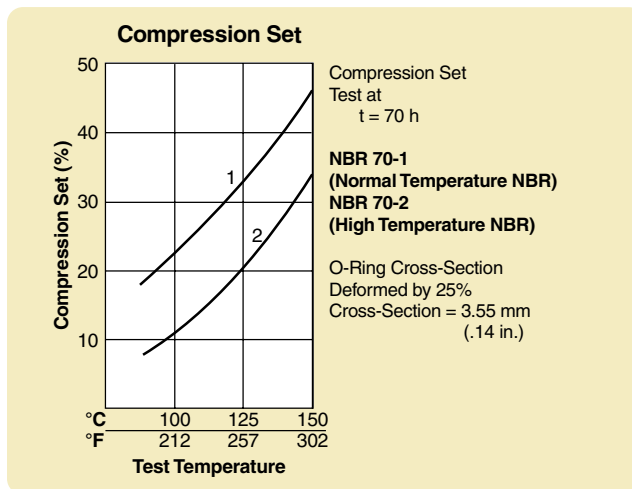

Figure 2-12: Compression Set vs. NBR 70 Compounds

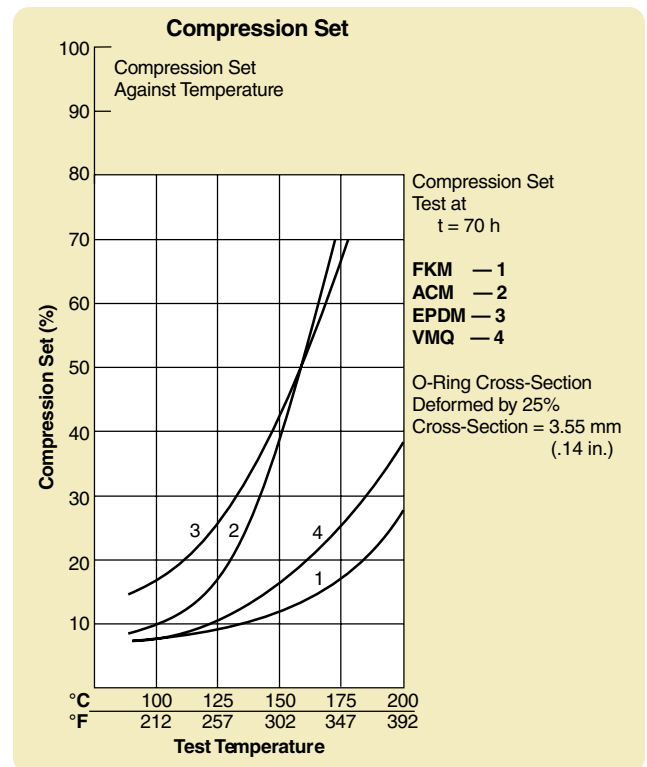

Figure 2-13: Compression Set vs. Polymer Family

WARNING: These products can expose you to chemicals including carbon black (airborne and extracts), antimony trioxide, titanium dioxide, silica (crystalline), di(2-ethylhexyl) phthalate, ethylene thiourea, acrylonitrile, 1,3-butadiene, epichlorohydrin, toluenediisocyanate, tetrafluoroethylene, ethylbenzene, formaldehyde, furfuryl alcohol, glass fibers, methyl isobutyl ketone, nickel (metallic and compounds), lead and lead compounds which are known to the State of California to cause cancer; and 1,3-butadiene, epichlorohydrin, di(2-ethylhexyl)phthalate, di-isodecyl phthalate, ethylene thiourea, methyl isobutyl ketone, methanol, toluene, lead and lead compounds which are known to the State of California to cause birth defects and other reproductive harm. For more information go to www.P65Warnings.ca.gov.

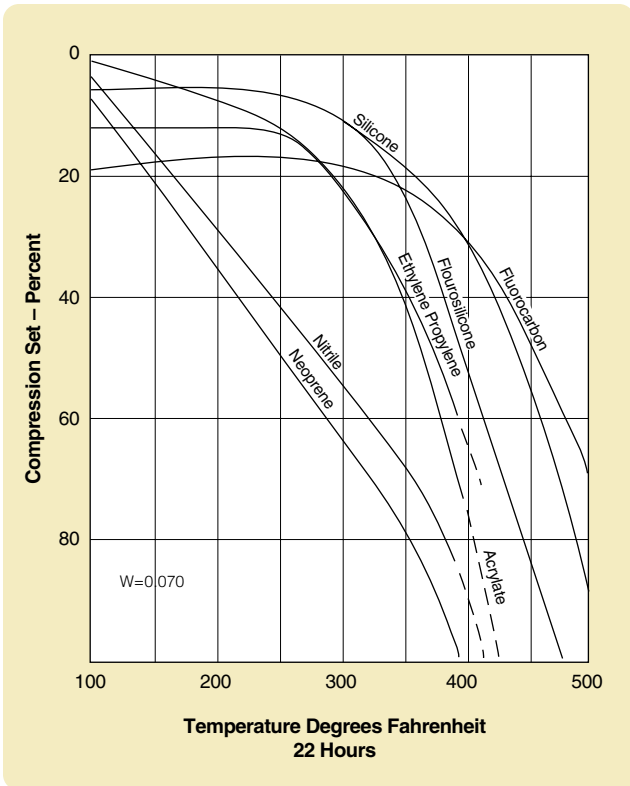

Figure 2-14: Compression Set .070 Cross Section

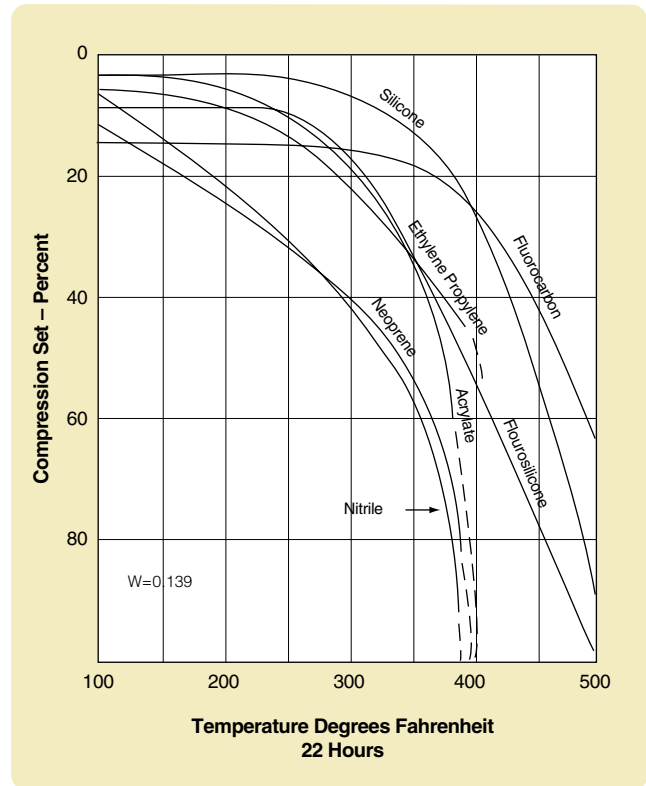

Figure 2-15: Compression Set .139 Cross Section

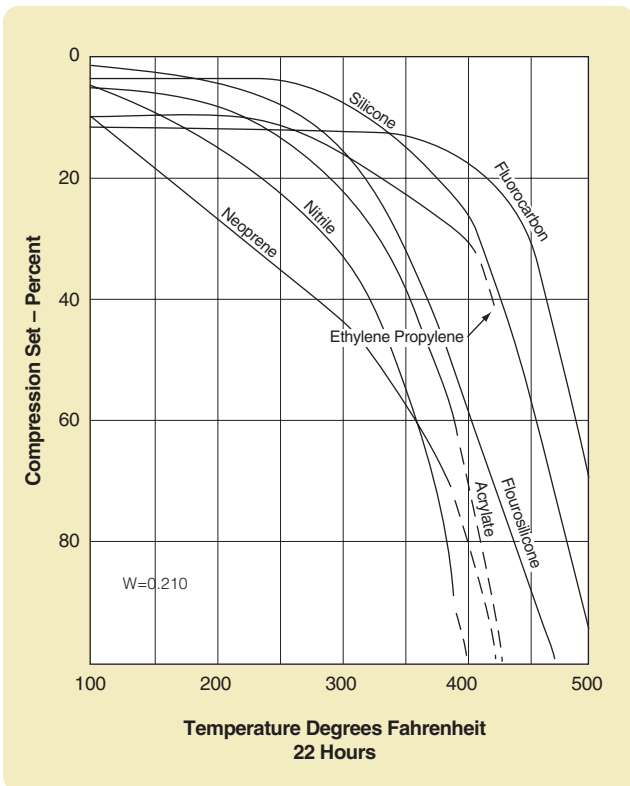

Figure 2-16: Compression Set .210 Cross Section

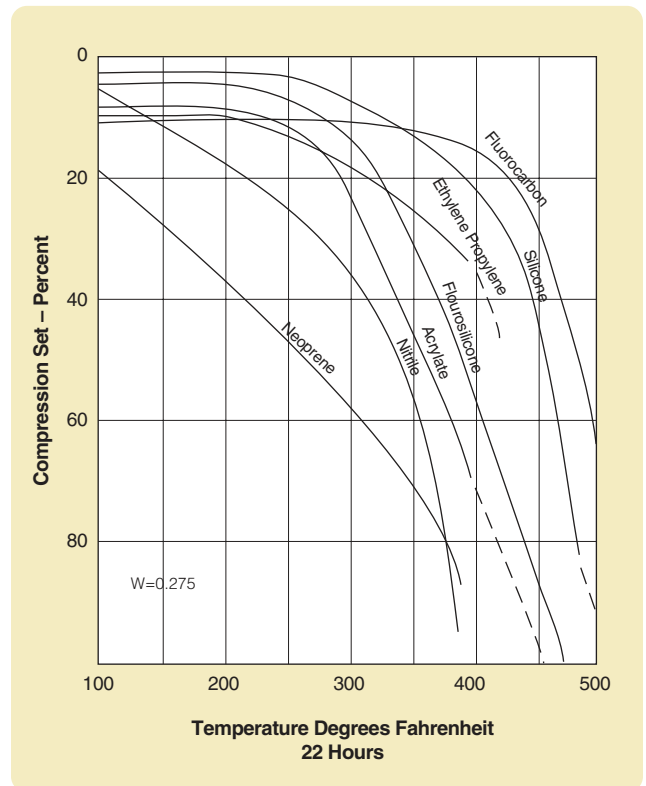

Figure 2-17: Compression Set .275 Cross Section

WARNING: These products can expose you to chemicals including carbon black (airborne and extracts), antimony trioxide, titanium dioxide, silica (crystalline), di(2-ethylhexyl) phthalate, ethylene thiourea, acrylonitrile, 1,3-butadiene, epichlorohydrin, toluenediisocyanate, tetrafluoroethylene, ethylbenzene, formaldehyde, furfuryl alcohol, glass fibers, methyl isobutyl ketone, nickel (metallic and compounds), lead and lead compounds which are known to the State of California to cause cancer; and 1,3-butadiene, epichlorohydrin, di(2-ethylhexyl)phthalate, di-isodecyl phthalate, ethylene thiourea, methyl isobutyl ketone, methanol, toluene, lead and lead compounds which are known to the State of California to cause birth defects and other reproductive harm. For more information go to www.P65Warnings.ca.gov.

2.4.12 Thermal Effects

All rubber is subject to deterioration at high temperature. Volume change and compression set are both greatly influenced by heat. Hardness is influenced in a rather complex way. The first effect of increased temperature is to soften the compound. This is a physical change, and will reverse when the temperature drops. However, it must be considered in high pressure applications because a compound that is sufficiently hard to resist extrusion at room temperature may begin to flow and extrude through the clearance gap as the temperature rises, due to this softening effect.

With increasing time at high temperature, chemical changes slowly occur. These generally cause an increase in hardness, along with volume and compression set changes as mentioned above. Changes in tensile strength and elongation are also involved. Being chemical in nature, these changes are not reversible.

With the exception of the cryogenics field, the tendency is to overlook the effects of low temperatures on elastomeric seal compounds as they are generally reversible as the temperature rises.

Any changes induced by low temperature are primarily physical and, as stated, are reversible. An elastomer will almost completely regain its original properties when warmed. There are several tests that are used to define low temperature characteristics of a compound, but there does not seem to be much correlation among them. Perhaps the best of the low temperature tests is TR-10 or Temperature Retraction Test.

The TR-10 test results are easily reproducible and are used extensively in many different specifications, not only for assuring low temperature performance but occasionally as a quality assurance measure as well. From experience, we have found that most compounds will provide effective sealing at 8°C (15°F) below their TR-10 temperature values. However, careful study of the paragraphs on “temperature” later in this section and in Section III should be made before selecting a compound for low temperature service.

If low pressures are anticipated at low temperature, hardness should be considered along with the low temperature properties of the compound. As temperature decreases, hardness increases. Low pressures require a soft material that can be easily deformed as it is forced against mating surfaces. It is possible that a 70 durometer compound at room temperature might harden to 85 durometer at -34°C (-30°F) and fail to respond to low pressure at this temperature.

On the other hand, the same type of compound with 40 durometer hardness at room temperature may register only 75 durometer at -34°C (-30°F) and provide somewhat better response. In moderate pressure service, low temperature hardness increase is seldom of consequence. However, hardness is only one of several factors to consider when low temperature performance is involved.

Flexibility, resilience, compression set and brittleness are perhaps more basic criteria for sealing at low temperature than measured hardness. This may be demonstrated by

reference to Figure 2-18 that shows the variation in hardness for several elastomers at low temperatures.

It is significant that many of the materials for which hardness is plotted in Figure 2-18 are considered good for seal service at temperatures considerably below that at which durometer hardness tends to reach a maximum. This clearly illustrates that durometer measurements alone are not reliable determinants of low temperature seal performance. The swelling or shrinkage effect of the fluid being sealed must also be taken into account. If the seal swells, it is absorbing fluids which may act in much the same way as a low temperature plasticizer, allowing the seal to remain more flexible at low temperature than was possible before the absorption of the fluid.

If the seal shrinks, something is being extracted from the compound. The greater part of the leached material is usually the plasticizer provided by the compounder for low temperature flexibility. This being the case, the seal may now lose some of its original flexibility at low temperature. It may become stiff at a temperature 2°C to 5°C (5°F to 10°F) higher than that at which it is rated.

Crystallization is another side effect of low temperature operation that must be considered, especially for dynamic applications. (Crystallization is the re-orientation of molecular segments causing a change of properties in the compound). When a compound crystallizes it becomes rigid and has none of the resilience that is so necessary for an effective seal.

This phenomenon manifests itself as a flat spot on the O-ring and is sometimes misinterpreted as compression set. The flatness will gradually disappear and the seal will regain its original resilience upon warming. Initially, it may take two or three months for a compound to crystallize at a low or moderate temperature. However, on succeeding exposures to low temperature, crystallization sets in much more rapidly.

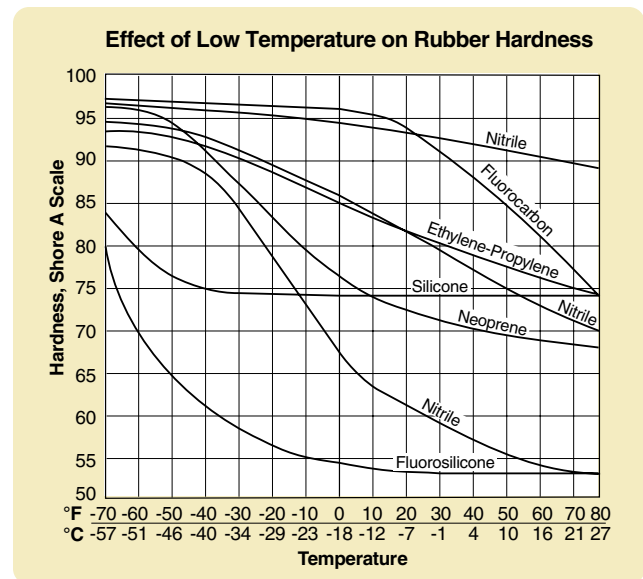

Figure 2-18: Effect of Low Temperature on Rubber Hardness

WARNING: These products can expose you to chemicals including carbon black (airborne and extracts), antimony trioxide, titanium dioxide, silica (crystalline), di(2-ethylhexyl) phthalate, ethylene thiourea, acrylonitrile, 1,3-butadiene, epichlorohydrin, toluenediisocyanate, tetrafluoroethylene, ethylbenzene, formaldehyde, furfuryl alcohol, glass fibers, methyl isobutyl ketone, nickel (metallic and compounds), lead and lead compounds which are known to the State of California to cause cancer; and 1,3-butadiene, epichlorohydrin, di(2-ethylhexyl)phthalate, di-isodecyl phthalate, ethylene thiourea, methyl isobutyl ketone, methanol, toluene, lead and lead compounds which are known to the State of California to cause birth defects and other reproductive harm. For more information go to www.P65Warnings.ca.gov.

The end result of crystallization is seal leakage. For example, seals which have been known to function satisfactorily in an air conditioning unit through the first summer, have failed during storage because the system was not turned on to pressurize the seals through a long, cold winter. One way to test for the crystallization effect is to use a double temperature drop. After conditioning at a moderately low temperature for a long period — say two months — temperature is lowered another 30°C (86°F) or so and leakage checked at .7 to 1.4 Bar (10 to 20 psi) pressure. Certain types of polychloroprene (Neoprene) have a pronounced tendency to crystallize. Spring-loading the seal can compensate for crystallization.

2.4.13 Resilience

Resilience is essentially the ability of a compound to return quickly to its original shape after a temporary deflection. Reasonable resilience is vital to a moving seal. Resilience is primarily an inherent property of the elastomer. It can be improved somewhat by compounding. More important, it can be degraded or even destroyed by poor compounding techniques. It is very difficult to create a laboratory test which properly relates this property to seal performance. Therefore, compounding experience and functional testing under actual service conditions are used to insure adequate resilience.

2.4.14 Deterioration

This term normally refers to chemical change of an elastomer resulting in permanent loss of properties. It is not to be confused with reversible or temporary property losses. Both permanent and temporary property losses may be accompanied by swell. The temporary condition is due to physical permeation of fluid without chemical alteration.

2.4.15 Corrosion

Corrosion is the result of chemical action of a fluid and/or the elastomer compound upon the metal surfaces of the seal gland cavity. This handbook is primarily concerned with corrosive effects caused by the compound alone, although it should be noted that fluid corrosion of the gland metal will cause a change of surface finish that can seriously affect the seal, especially in a dynamic application. When rubber seals were first used, there were numerous instances in which the compound itself did act adversely upon metal causing actual pitting of the gland surface. Certain elastomer compounding ingredients, such as uncombined sulfur or certain types of carbon black were found to cause the problem.

Currently, compounding expertise, modern chemicals and supplier testing has made reports of this type of corrosion rare. However, due to frequent introduction of new and improved compounding ingredients, continuous attention to potential corrosive effects is necessary.

A. Corrosion Caused by Free Sulphur — Rubber compounds often are vulcanized using an accelerator containing the element sulfur. A large percentage of the sulfur under the influence of heat (vulcanization) forms bridges (cross-links) between the elastomer molecule chains. This sulfur

remains chemically fixed and cannot be extracted. However a smaller portion of the sulfur remains free and not fixed in the elastomer structure.

Free sulfur in contact with many metals and alloys (e.g. silver, copper, lead) tends to form metal sulfides which cause discoloring and corrosion damage. Further, a reaction between metal and sulfur can lead to the failure of a dynamic seal if rubber adheres to the metal surface after a long downtime. In all cases where there is dynamic action expected at the seal interface, use of a sulfur-free compound is recommended.

B. Corrosion Caused by the Formation of Hydrochloric Acid — Hydrochloric (HCl) acid can be formed in certain environmental conditions when free chloride is present in an elastomer.

Compounds in the CR, ECO, CO and to a lesser extent in ACM polymer groups tend to cause corrosion if the formula does not contain sufficient amounts of inhibitors and stabilizers (e.g. metal oxides) which retard free chloride. Hydrochloric acid also can be formed around compounds which are free from chloride (e.g. SBR, NR) if they contain chloro-paraffin combinations which are used as flame retardants.

C. Electrochemical Corrosion — The formation of small galvanic cells is the main mechanism responsible for corrosion of metals. A galvanic cell is formed across two dissimilar metals. An electrolyte is required for the function of a galvanic cell. Alloys made up from different metal phases or crystals can be damaged when small local cells are formed.

Electrochemical corrosion in the zone of a sealing element (e.g. an O-ring) does not necessarily mean that the elastomer is always the cause. It is very difficult to say how far electrochemical corrosion depends on the elastomer. It is generally assumed that condensate accumulates between the rubber and the metal which, together with other impurities, causes electrochemical corrosion. The propensity to corrode depends on the type of metal alloy(s), surface roughness, state of the metal, temperature and humidity.

2.4.16 Permeability

Permeability is the tendency of gas to pass or diffuse through the elastomer. This should not be confused with leakage which is the tendency of a fluid to go around the seal. Permeability may be of prime importance in vacuum service and some few pneumatic applications involving extended storage but is seldom consequential in other applications. It should be understood that permeability increases as temperatures rise, that different gases have different permeability rates, and that the more a seal is compressed, the greater its resistance to permeability. Refer to O-Ring Applications, Section III for additional information on permeability and vacuum service.

2.4.17 Joule Effect

If a freely suspended rubber strip is *loaded* and stretched and subsequently heated, the strip will contract and lift the load. Conversely, an *unloaded* strip when heated expands to the



WARNING: These products can expose you to chemicals including carbon black (airborne and extracts), antimony trioxide, titanium dioxide, silica (crystalline), di(2-ethylhexyl) phthalate, ethylene thiourea, acrylonitrile, 1,3-butadiene, epichlorohydrin, toluenediisocyanate, tetrafluoroethylene, ethylbenzene, formaldehyde, furfuryl alcohol, glass fibers, methyl isobutyl ketone, nickel (metallic and compounds), lead and lead compounds which are known to the State of California to cause cancer; and 1,3-butadiene, epichlorohydrin, di(2-ethylhexyl)phthalate, di-isodecyl phthalate, ethylene thiourea, methyl isobutyl ketone, methanol, toluene, lead and lead compounds which are known to the State of California to cause birth defects and other reproductive harm. For more information go to www.P65Warnings.ca.gov.

coefficient of expansion for that rubber. This phenomenon of contraction is termed the *Joule effect* and occurs only when heating a stretched rubber object.

Example:

O-ring as radial shaft seal. The O-ring with an inner diameter smaller than the shaft is fitted under tension. The O-ring heats up due to friction and contracts. The result is increased friction and temperature. Failure of the O-ring is characterized by a hard, brittle O-ring surface.

In practice an O-ring of larger inner diameter must therefore be selected. An inner diameter between 1% to 3% larger than the shaft is recommended and the outer diameter of the gland should ensure that the O-ring is compressed on the shaft surface.

The width of the gland should be slightly less than the cross-section diameter. The O-ring always should be fitted into the bore and never on to the shaft.

2.4.18 Coefficient of Friction

Coefficient of friction of a moving elastomer seal relates to a number of factors including material hardness, lubrication and surface characteristics of surrounding materials. Generally, breakout friction is many times that of running friction. This varies with several factors, primarily hardness of the seal material. When only the hardness is changed, an increase in hardness will increase breakout friction while a decrease will lower breakout friction. In those instances where seal external lubrication is impossible, Parker offers several compounds having self-contained lubricants. These compounds are also desirable where continuous presence of a lubricant is uncertain, and where minimal friction is essential. For more friction data see O-Ring Applications and Dynamic O-Ring Sealing, Sections III and V, respectively.

2.4.19 Electrical Properties

Elastomers may be good insulators, semiconductors or conductors. The type of material and compound (electrically conductive carbon black) are selected to electrical requirements criteria:

Electrically insulating: $> 10^9$ ohms-cm - SBR, IIR, EPDM, VMQ, FKM.

Anti-static, as semiconductor: 10^5 to 10^9 ohms-cm - NBR, CR.

Electrically conductive: $< 10^5$ ohms-cm - Special Compounds. See Parker Chomerics Division.

Many elastomers must be minimally conductive to prevent electrostatic charging, e.g. fuel tank seals, drive belts, medical equipment, etc. When special conductive compounds are required, care should be taken to ensure that conductive parts of the compound formula will not be dissolved or extracted by the medium being sealed, thus changing the electrical properties. See Figure 2-19.

For shielding purposes against electromagnetic interference (EMI), compounds filled with conductive-particles have been developed with a volume resistivity of $< 10^{-2}$ Ohm-cm.

Please contact Parker regarding any special compound requirements and specific physical properties when contemplating the use of conductive elastomers. For more in-depth information on conductive elastomers and EMI shielding, see Parker Chomerics product information.

2.4.20 Coefficient of Thermal Expansion

Coefficient of linear expansion is the ratio of the change in length per °C to the length at 0°C. Coefficient of volumetric expansion for solids is approximately three times the linear coefficient. As a rough approximation, elastomers have a coefficient of expansion ten times that of steel (an exception to this is perfluoroelastomer). This can be a critical factor at high temperature if the gland is nearly filled with the seal, or at low temperature if squeeze is marginal. See Table 2-5.

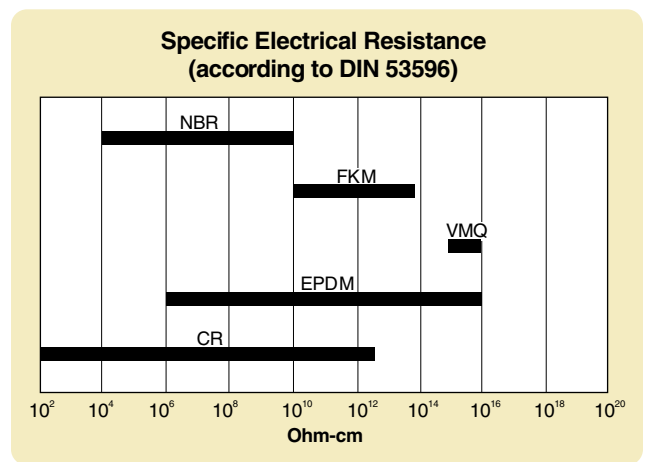

Figure 2-19: Specific Electrical Resistance (According to DIN 53596)

Linear Thermal Expansion of Typical Elastomers and Common Materials

Material	Contraction		Coefficient of Expansion (in./in.°F)
	24°C to -54°C (75°F to -65°F) (in./ft.)	Expansion 24°C to 191°C (75° to 375°F) (in./ft.)	
Nitrile — General Purpose	.108	.224	6.2×10^{-5}
Neoprene	.132	.274	7.6×10^{-5}
Parofluor			1.8×10^{-4}
Fluorocarbon Elastomer	.156	.324	9.0×10^{-5}
Kel-F	.144	.299	8.3×10^{-5}
Ethylene Propylene	.155	.320	8.9×10^{-5}
Silicone	.174	.360	1.0×10^{-4}
Low-Temperature Type Silicone	.193	.396	1.1×10^{-4}
Fluorosilicone	N/A	N/A	1.5×10^{-4}
High-Temperature Type Aluminum, 2017	.023	.047	1.3×10^{-5}
Stainless Steel, Type 302	.017	.035	9.6×10^{-6}
Steel, Mild	.012	.024	6.7×10^{-6}
Invar	.001	.002	6.0×10^{-7}

Table 2-5 : Linear Thermal Expansion of Typical Elastomers and Common Materials

WARNING: These products can expose you to chemicals including carbon black (airborne and extracts), antimony trioxide, titanium dioxide, silica (crystalline), di(2-ethylhexyl) phthalate, ethylene thiourea, acrylonitrile, 1,3-butadiene, epichlorohydrin, toluenediisocyanate, tetrafluoroethylene, ethylbenzene, formaldehyde, furfuryl alcohol, glass fibers, methyl isobutyl ketone, nickel (metallic and compounds), lead and lead compounds which are known to the State of California to cause cancer; and 1,3-butadiene, epichlorohydrin, di(2-ethylhexyl)phthalate, di-isodecyl phthalate, ethylene thiourea, methyl isobutyl ketone, methanol, toluene, lead and lead compounds which are known to the State of California to cause birth defects and other reproductive harm. For more information go to www.P65Warnings.ca.gov.

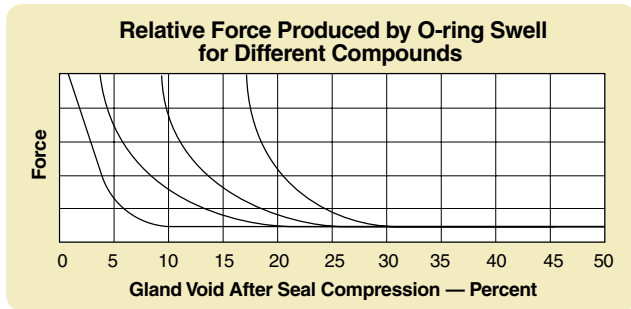

Figure 2-20: Relative Force Produced by O-ring Swell

There are certain reactions that in some circumstances cause a seal to exert relatively high forces against the sides of a groove. These forces are generated by thermal expansion of the rubber and/or swelling effect of a fluid.

If the seal is completely confined and the gland is 100% filled, the dominating force is the force of thermal expansion of the rubber. There have been instances where a seal has ruptured a steel gland due to expansion when heated.

Effective force exerted by the seal due to fluid swell is another potentially large factor if the gland volume exceeds that of the seal by only 5 to 10% (see Figure 2-20). Depending on the interaction between the rubber and the fluid being sealed, the effect may be quite pronounced even at larger gland void conditions.

2.4.21 Effects on Properties

In some of the foregoing paragraphs, it has been mentioned that various factors can alter the properties of rubber materials. Low temperatures cause reversible hardening of compounds, high temperatures may cause reversible and non-reversible changes of many kinds, and exposure to fluids can effect all the properties of a rubber material. Besides these more-or-less obvious effects, there are many additional ways in which the properties of a compound may be modified so that results by two different laboratories may not agree. Knowledge of some of these pitfalls may avoid misunderstandings.

2.5 Standard Test Procedures

There are standard ASTM procedures for conducting most of the tests on rubber materials. It is important to follow these procedures carefully in conducting tests if uniform and repeatable results are to be obtained. For instance, in pulling specimens to find tensile strength, elongation, and modulus values, ASTM D412 requires a uniform rate of pull of 508 mm (20 inches) per minute. In one test, tensile strength was found to decrease 5% when the speed was reduced to 50.8 mm (2 inches) per minute, and it decreased 30% when the speed was further reduced to 5.08 mm (0.2 inches) per minute. Elongation and modulus values decreased also, but by smaller amounts.

ASTM Compression Set D395 Test Method B, states, “The percentage of compression employed shall be approximately 25%.” We have found significantly higher compression set values after compressing less than 25%, while results after 30 or 40% compression were sometimes smaller and sometimes greater than at 25%.

2.5.1 Test Specimens

ASTM test methods include descriptions of standard specimens for each test. Often, two or more specimens are required, but results from the different specimens will seldom agree. The way that properties vary with the size of the specimen is not consistent. For instance, as the cross-section increases, nitrile O-rings produce lower values of tensile strength, elongation, and compression set. Ethylene propylene rings produce a similar pattern for tensile and elongation values but not compression set, while in fluorocarbon compounds only the elongation shows this trend.

In fluid immersion tests, rings with smaller cross-sections have been found to swell more than larger rings. In observing explosive decompression tests, the smaller cross-sections had much better resistance to high-pressure gases.

When customers wish to monitor the Shore A hardness of O-rings they purchase, they will sometimes order compression set buttons from the same batch as the O-rings for purposes of conducting hardness tests. This is because durometer hardness readings taken on actual O-rings are notoriously variable. It is important, therefore, in reporting test results, to include both a description of the test specimens used as well as describing the test method itself in detail.

2.5.2 Test Method Variables

More difficult to avoid are differences in test results due to differences introduced by the human equation. In testing for durometer hardness, for example, the presser foot of the instrument is applied to the specimen “as rapidly as possible without shock — Apply just sufficient pressure to obtain firm contact between presser foot and specimen.” Different operators will often disagree on the hardness of a compound because they use different speeds and different amounts of pressure. In gauging the hardness of an O-ring, which has no flat surface, operators may vary in the accuracy with which they apply the indenter to the actual crown of the O-ring, the point that gives the most reliable reading. The only industry recognized test for hardness of an O-ring is IRHD (see “Hardness” in this section).

In conducting the TR-10 low temperature test, the cold bath should be warmed at the rate of 1°C (34°F) per minute. Any different rate will result in somewhat different readings.

2.5.3 Effects of Environment on Testing

High humidity in the air will reduce the tensile strength of some compounds. Changes in a fluid medium can occur in service due to the effect of heat and contaminants. A rubber that is virtually unaffected by new fluid may deteriorate in the same fluid after it has been in service for a month. Tests are sometimes run in previously used fluid for this reason.

These are but a few examples to illustrate the fact that the properties of rubber compounds are not constant. They vary according to the conditions under which they are tested, and some of the variables may be rather subtle.

WARNING: These products can expose you to chemicals including carbon black (airborne and extracts), antimony trioxide, titanium dioxide, silica (crystalline), di(2-ethylhexyl) phthalate, ethylene thiourea, acrylonitrile, 1,3-butadiene, epichlorohydrin, toluenediisocyanate, tetrafluoroethylene, ethylbenzene, formaldehyde, furfuryl alcohol, glass fibers, methyl isobutyl ketone, nickel (metallic and compounds), lead and lead compounds which are known to the State of California to cause cancer; and 1,3-butadiene, epichlorohydrin, di(2-ethylhexyl)phthalate, di-isodecyl phthalate, ethylene thiourea, methyl isobutyl ketone, methanol, toluene, lead and lead compounds which are known to the State of California to cause birth defects and other reproductive harm. For more information go to www.P65Warnings.ca.gov.

2.6 Aging

Deterioration with time or aging relates to the basic nature of the rubber molecule. It is a long chain-like structure consisting of many smaller molecules joined or linked together. Points at which individual molecules join are called bonds. Bond sites and certain other areas may be particularly susceptible to chemical reaction. At least three principle types of such reactions are associated with aging. They usually occur concurrently, but in varying degrees:

- Scission — The molecular bonds are cut, dividing the chain into smaller segments. Ozone, ultra-violet light, and radiation cause degradation of this type.
- Crosslinking — An oxidation process whereby additional intermolecular bonds are formed. This process may be a regenerative one. Heat and oxygen are principle causes of this type of aging process.
- Modification of Side Groups — A change in the complex, weaker fringe areas of the molecular construction due to chemical reaction. Moisture, for example, could promote this activity.

Note: all mechanisms by which rubber deteriorates with time are attributable to environmental conditions. It is *environment* and not age that is significant to seal life, both in storage and actual service. While selection and application of synthetic rubber seals to provide acceptable service life is the primary subject of this handbook, our concern in the next paragraph will be with seal life as it relates to storage conditions.

2.7 Storage

The effective storage life of an O-ring varies with the inherent resistance of each individual elastomer to normal storage conditions. ARP 5316 places elastomers into three groups according to “Age resistance generally associated with products fabricated from various rubbers.” Realize that this document, ARP 5316, is an Aerospace Recommended Practice, not a standard that must be met.

Where non-age sensitive elastomers are involved, considerable storage life *without* detectable damage is common even under adverse conditions. For materials falling into the 15 year category, which are subject to age deterioration, the following conditions are suggested for maximum life:

- Ambient temperature not exceeding 49°C (120°F)
- Exclusion of air (oxygen)
- Exclusion of contamination
- Exclusion of light (particularly sunlight)
- Exclusion of ozone generating electrical devices
- Exclusion of radiation

Generally, sealed polyethylene bags stored in larger cardboard containers or polyethylene lined craft paper bags ensure optimal storage life. However, in normal warehousing conditions, life of even the relatively age-sensitive elastomers is considerable. This is due to major improvements in modern compounding technique, and has been documented

through a number of investigations concerned with effects of long-term storage of elastomeric materials undertaken in the recent past. These include controlled laboratory studies of many years duration in addition to evaluation of seals recovered from salvaged World War II aircraft and other sources after exposure to widely varying conditions over many years.

2.8 Cure Date

To facilitate proper stock rotation on the shelves of Parker distributors and customers, Parker Seal supplies the cure date on all packaging. It is standard practice throughout the industry to indicate the cure date by quarter and calendar year. When determining the age of a part, the quarter of manufacture (cure) is not counted. For example, parts cured in January, February, or March of a given year are not considered to be one quarter old until July 1 of that same year. Cure dates are shown by a number indicating the quarter of cure followed by the letter Q (for quarter). For example, 2Q06 indicates the second quarter of 2006 (April, May, or June).

2.9 Age Control

Prior to ARP 5316, specification MIL-STD-1523A was the age control document for O-rings. Although cure date records are maintained for all Parker Seal elastomer products, not all of these products were subject to the age control limitations of MIL-STD-1523A. It required that the age of certain military nitrile O-rings shall not exceed 40 quarters from the cure date at the time of acceptance by the Government acquiring activity. The age control requirements of MIL-STD-1523A did not apply to any other polymer classes, such as fluorocarbon, butyl, ethylene propylene, silicone, fluorosilicone, polyurethane, etc. nor to nitrile compounds not covered by the specification.

Note: As of this printing, MIL-STD-1523A has been cancelled. It is included here for historical reference only. Refer to ARP 5316 as a guide (ARP 5316 is available through SAE).

Field experience has demonstrated that the current **STORAGE CONDITIONS** are much more important in determining the useful life of elastomeric seals than is **TIME**. Controlling storage time only serves to de-emphasize the need for adequate control of storage conditions. Adhering to this time-based storage philosophy may result in deteriorated seals, or in the wasteful destruction of perfectly good seals.

2.10 Shrinkage

All rubber compounds shrink to some extent during the molding process. The finished elastomeric part will be smaller than the mold cavity from which it was formed. Exactly how much smaller the part is we call the “shrinkage factor.” The basic nitrile polymer was one of the first synthetic polymers produced. As a result, it has become the standard or “measuring stick” for shrinkage variations between polymer families. This standard shrinkage factor is often called “AN” shrinkage. For other compounds, individual shrinkage factors can lead to



WARNING: These products can expose you to chemicals including carbon black (airborne and extracts), antimony trioxide, titanium dioxide, silica (crystalline), di(2-ethylhexyl) phthalate, ethylene thiourea, acrylonitrile, 1,3-butadiene, epichlorohydrin, toluenediisocyanate, tetrafluoroethylene, ethylbenzene, formaldehyde, furfuryl alcohol, glass fibers, methyl isobutyl ketone, nickel (metallic and compounds), lead and lead compounds which are known to the State of California to cause cancer; and 1,3-butadiene, epichlorohydrin, di(2-ethylhexyl)phthalate, di-isodecyl phthalate, ethylene thiourea, methyl isobutyl ketone, methanol, toluene, lead and lead compounds which are known to the State of California to cause birth defects and other reproductive harm. For more information go to www.P65Warnings.ca.gov.

different tolerances and, thus, different designs. If, with the variation of compound and hardness, the ability to fall within expected dimensional tolerances is compromised, is necessary to manufacture compensating mold tooling in order to remain within the specified tolerances, whatever they may be.

For more information on shrinkage, see “Shrinkage” in the Appendix, Section X.

2.11 Compound Selection

This section gives background information to help in understanding the factors involved in the process, and provide some guidance when recommended limits must be exceeded or when unlisted fluids are encountered. Compound selection may be classified in two categories — the pioneering type and the non-pioneering type.

If no pioneering were ever encountered, it would be possible to skip all the other sections of this handbook and select the proper compound for an application from the tables. Since non-pioneering applications will include the greater part of all design work normally encountered, this category will be discussed first.

2.11.1 Non-Pioneering Design

The term “non-pioneering design” refers to reapplication of proven design. Three such cases come to mind immediately:

1. When using the same fluid, gland design practices, and operating conditions, the same compounds utilized in past design may be trusted to give successful results.
2. When the military service or other customer requires the use of some specific compound by citing a formulation, compound designation, or specification, the designer must locate the compound that meets such criteria and no option exists as to compound choice. By use of such specifications, the problem becomes “non-pioneering” in that known successful solutions are relied on. For such design conditions, Tables 8-3, 8-4 and 8-5 list the most used specifications and indicate applicable Parker compounds.
3. There is a third case of “non-pioneering design” in which the designer can use past successes of others as a basis for a design foreign to his own experience. The sections on Static and Dynamic O-Ring Sealing (Sections IV and V, respectively) provide gland design data based on “average” operating conditions, established by widespread field contact developed from years of experience with O-rings. In similar fashion, many stock compounds have proven to be very satisfactory in certain fluids when used in glands of normal design. Provided operating conditions are within specified limits, gland design presents nothing new, and no problems should arise. The Fluid Compatibility Tables in Section VII provide specific seal compound recommendations for service with a variety of fluids. Each foregoing category is based on successful practice under similar service conditions. This is the heart of the non-pioneering approach.

2.11.2 Pioneering Design

This implies that there is something new and therefore unknown or at least unproven about the design. There are at least two recognizable levels in this area that we elect to call “minor pioneering” and “major pioneering.”

- A. Minor Pioneering applies when only a slight departure from previous practice is involved. If new operating conditions apply or some change in gland design is made but neither is radically different from the past design conditions, the previous design data will certainly apply as a starting point. If a fluid is new to the user, but is listed in the Fluid Compatibility Table in Section VII, influence of the fluid retains “minor pioneering” status. (If the new fluid is foreign to the user’s experience and not listed in the table, the problem has suddenly become “major pioneering.”) Each designer makes his own choice of how to test a new design and his decision should be based on how far the application deviates from known successful usage.
- B. Major Pioneering applies when there is radical departure from previous practice. The most likely example is the use of a new fluid, foreign to anyone’s past experience. If the fluid’s chemical nature can be related to another fluid with known effect on a compound, this may reduce the problem to “minor pioneering.”

For example, if the fluid is a silicate ester, it can be surmised that its effect on the seal will be similar to MLO-8200, MLO-8515, or OS 45 type III and IV, since these also have a silicate ester base. In the case of petroleum base fluids, comparison of the aniline point of the fluid with that of standard test fluids gives a fair estimate of the fluid’s effect on a seal material.

It is fortunate that major engineering problems constitute only a very small percentage of the total work, for they do not normally offer a direct and immediate answer. However, by using the Fluid Compatibility Tables in Section VII it should be relatively simple to select one or two compounds for trial. The most likely compound should then be put on simulated service test. If performance is satisfactory, the answer is at hand. If not, a more accurate analysis and a better compound selection may be made based on test results.

In summary, selecting an applicable compound is a matter of finding a “reasonable” starting point and proving the adequacy of such a selection by functional testing.

2.12 Rapid Methods for Predicting the Compatibility of Elastomers with Mineral Based Oils

2.12.1 Aniline Point Differences

In view of the ever increasing number of operating oils and sealing materials, it is desirable that a means be established to enable interested parties to employ suitable combinations of oil and rubber without the need for carrying out lengthy immersion tests on each combination.



WARNING: These products can expose you to chemicals including carbon black (airborne and extracts), antimony trioxide, titanium dioxide, silica (crystalline), di(2-ethylhexyl) phthalate, ethylene thiourea, acrylonitrile, 1,3-butadiene, epichlorohydrin, toluenediisocyanate, tetrafluoroethylene, ethylbenzene, formaldehyde, furfuryl alcohol, glass fibers, methyl isobutyl ketone, nickel (metallic and compounds), lead and lead compounds which are known to the State of California to cause cancer; and 1,3-butadiene, epichlorohydrin, di(2-ethylhexyl)phthalate, di-isodecyl phthalate, ethylene thiourea, methyl isobutyl ketone, methanol, toluene, lead and lead compounds which are known to the State of California to cause birth defects and other reproductive harm. For more information go to www.P65Warnings.ca.gov.

A well-known rapid method for material selection is based on the aniline point of the oil, which is the lowest temperature at which a given amount of fresh aniline dissolves in an equal volume of the particular oil. Oils with the same aniline points usually have similar effect on rubber. The lower the aniline point, the more severe is the swelling action. The ASTM reference oils cover a range of aniline points found in lubricating oils.

ASTM Oil No. 1 has a high aniline point 124°C (225°F) and causes slight swelling or shrinkage.

IRM 902 (formally ASTM Oil No. 2) has a medium aniline point of 93°C (200°F) and causes intermediate swelling.

IRM 903 (formally ASTM Oil No. 3) has a low aniline point 70°C (157°F) and causes high or extreme swelling of seal compounds.

With mineral oil as a medium, changes in physical properties are the result of two different processes:

- A. Oil diffuses into the rubber causing swelling which is usually limited and differs from one elastomer to another.
- B. Chemical components of the elastomer can be dissolved or extracted from the compound resulting in shrinkage.

The processes can be concurrent and the resulting volume change may not be noticeable.

The effect depends not only on the construction of the elastomer, but also on the sealed fluid itself. The base elastomer contains between 15% and 50% acrylonitrile (ACN). The higher the ACN content, the better the compatibility with oil. In the same way, a high content of aliphatics, e.g. as in paraffin based oils, leads to a low tendency to swell (also with low ACN content). Conversely, aromatic based oils cause

swelling, which for some elastomers does not tend to reach equilibrium, e.g. with NBR. A high ACN content is necessary to resist swelling resulting from naphthalene based oils.

Any other commercial oil with the same or similar aniline point can be expected to have a similar effect on a particular sealing material as the corresponding ASTM oil. However, it has been found that the aniline point method is not always reliable. Some commercial oils of the same aniline point can differ significantly in their swelling power because they contain different sorts and amounts of additives.

2.12.2 Elastomer Compatibility Index

A rapid and more accurate method for predicting the compatibility of commercial rubbers in mineral based oils involves the use of a representative reference compound called standard NBR 1. The action of mineral oils can be evaluated against this standard rubber in terms of the Elastomer Compatibility Index or ECI. Table 2-6 lists the ECI for various oils.

Previous work has shown that there is an approximate linear relationship between the equilibrium percentage volume changes of NBR 1 in a range of mineral oils and those of any commercial nitrile in the same oils. In other words, if equilibrium percentage changes in the volume of different commercial nitrile rubbers in different mineral oils are plotted against those of standard elastomer NBR 1, a straight line can be obtained for each nitrile compound. This enables interested parties to predict the volume change of a particular rubber material in any mineral oil if the compatibility index of this oil (i.e. the percentage volume change of NBR 1) is known.

The straight-line graph for a particular compound is called the swelling behavior, or SB of the compound. Figure 2-21 gives an example of such a graph.

ECI for Various Oils	
Type of Oil	ECI
ASTM Oil Number 1	2.2 - 3.2
BP Energol HLP 100	3.7 - 4.7
Esso Nuto H-54 (HLP 36)	5.9 - 6.9
Houghton HD 20W/20	6.9 - 7.9
Esso Nuto H-44 (HLP 16)	7.1 - 8.1
DEA Rando Oil HDC (HLP 36)	7.7 - 8.7
Fina Hydran 31	8.5 - 9.5
Shell Tellus 923 (HLP 16)	9.2 - 10.2
ASTM Oil Number 2 (IRM 902)	9.4 - 10.4
Esso-Trafo oil 37	12.5 - 13.5
Agip F. 1 Rotra ATF	12.6 - 13.6
Mobil Vac HLP 16	14.0 - 15.0
Shell Tellus 15	14.7 - 15.7
Essocis J 43	15.0 - 16.0
Shell oil 4001	16.3 - 17.3
Texaco Rando Oil AAA	16.5 - 17.5
BP Energol HP 20	19.0 - 20.0
ASTM Oil Number 3 (IRM 903)	23.0 - 24.0
Shell Tellus 11	32.9 - 33.9
Shell Oil JYO	34.5 - 35.5

Table 2-6: ECI for Various Oils

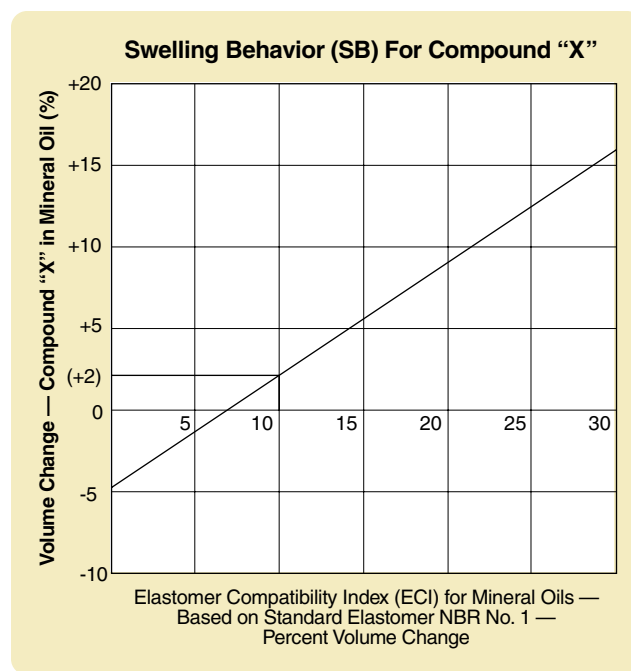

Figure 2-21: Swelling Behavior (SB) for Compound "X"

WARNING: These products can expose you to chemicals including carbon black (airborne and extracts), antimony trioxide, titanium dioxide, silica (crystalline), di(2-ethylhexyl) phthalate, ethylene thiourea, acrylonitrile, 1,3-butadiene, epichlorohydrin, toluenediisocyanate, tetrafluoroethylene, ethylbenzene, formaldehyde, furfuryl alcohol, glass fibers, methyl isobutyl ketone, nickel (metallic and compounds), lead and lead compounds which are known to the State of California to cause cancer; and 1,3-butadiene, epichlorohydrin, di(2-ethylhexyl)phthalate, di-isodecyl phthalate, ethylene thiourea, methyl isobutyl ketone, methanol, toluene, lead and lead compounds which are known to the State of California to cause birth defects and other reproductive harm. For more information go to www.P65Warnings.ca.gov.

Example using Figure 2-21:

To find the volume change of Compound “X” in a mineral oil having an ECI of 10 for volume, follow the 10% vertical ECI line until it intersects the slanted line. Follow the horizontal line from that point to the vertical axis. Compound “X” will have a volume swell of approximately 2% in that oil.

By using the ECI, the volume change of the above materials can be predicted in a mineral oil media, thus saving valuable laboratory time. The ECI for an oil is initially determined in the laboratory (see Table 2-6). The ECI values can be plotted on a compound specific graph (Figures 2-22 and 2-23) and the expected volume change can be read directly from the vertical axis. In this way, a decision can be made regarding elastomer compatibility with given oils. The procedure, originally developed by Parker, has been standardized under International Standard ISO 6072.

The weight change of a test elastomer, e.g. NBR 1 to ISO 6072, is measured after immersion in the respective oil for 168 hours at 100°C (212°F). The ECI is then simply read from Figure 2-24 plotting the weight change.

2.13 Operating Conditions

The practical selection of a specific Parker compound number depends on adequate definition of the principle operating conditions for the seal. In approximate order of application, these conditions are *Fluid, Temperature, Time, Pressure and Mechanical Requirements*.

2.13.1 Fluid

Fluid includes the fluid to be sealed, outside air, any lubricant, or an occasional cleaning or purging agent to be used in the system. For example, in pipelines it is common practice to pump a variety of fluids in sequence through a line with a pig

(floating plug) separating each charge. In a crankcase, raw gasoline, diesel fuel, gaseous products of combustion, acids formed in service, and water from condensation, can all be expected to contaminate the engine oil. In both these cases, the seal compound must be resistant to all fluids involved including any lubricant to be used on the seal. Therefore, whenever possible, it is a good practice to use the fluid being sealed as the lubricant, eliminating one variable.

Thus far only the effects of fluids on seal compounds have been discussed. Consideration must also be given to the effect of the compound on system fluids. For example:

- Some rubber compounding ingredients, such as magnesium oxide or aluminum oxide, used in compounds that cause chemical deterioration of fluorinated refrigerants. When choosing a compound for use with fluorinated refrigerants, it should not contain any of the ingredients that cause this breakdown.
- Compounds containing large amounts of free sulfur for vulcanization should not be used in contact with certain metals or fluids, because the sulfur will promote corrosion of the metal or cause chemical change of the fluid.
- Compounds for food and breathing applications should contain only non-toxic ingredients.
- Seals used in meters or other devices that must be read through glass, a liquid, or plastic, must not discolor these materials and hinder vision.

Sound judgment, then, dictates that all fluids involved in an application be considered. Once this is done, it is a simple matter to check the Fluid Compatibility Tables in Section VII to find a compound suitable for use with all the media.

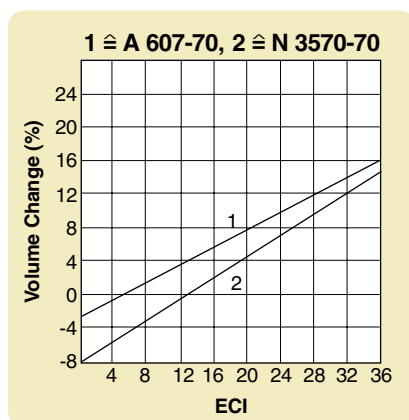

Figure 2-22: Swelling Characteristics of Parker Compounds

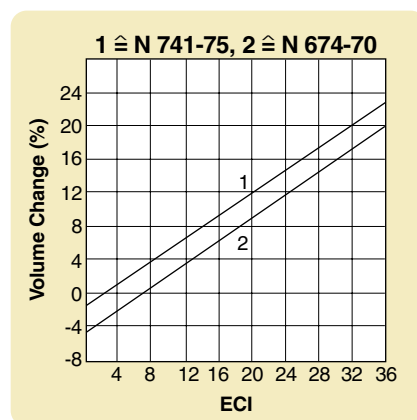

Figure 2-23: Swelling Characteristics of Parker Compounds

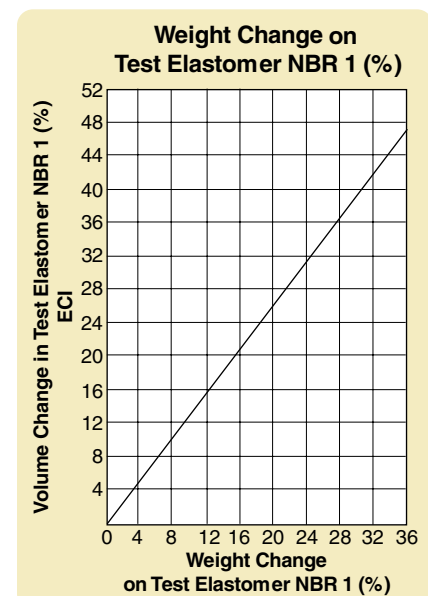

Figure 2-24: Weight Change on Test Elastomer NBR 1 (%)



WARNING: These products can expose you to chemicals including carbon black (airborne and extracts), antimony trioxide, titanium dioxide, silica (crystalline), di(2-ethylhexyl) phthalate, ethylene thiourea, acrylonitrile, 1,3-butadiene, epichlorohydrin, toluenediisocyanate, tetrafluoroethylene, ethylbenzene, formaldehyde, furfuryl alcohol, glass fibers, methyl isobutyl ketone, nickel (metallic and compounds), lead and lead compounds which are known to the State of California to cause cancer; and 1,3-butadiene, epichlorohydrin, di(2-ethylhexyl)phthalate, di-isodecyl phthalate, ethylene thiourea, methyl isobutyl ketone, methanol, toluene, lead and lead compounds which are known to the State of California to cause birth defects and other reproductive harm. For more information go to www.P65Warnings.ca.gov.

2.13.2 Temperature

Temperature ranges are often over-specified. For example, a torch or burner might reach temperatures of 400°C to 540°C (750°F to 1000°F). However, the tanks of gas being sealed may be located a good distance from this heat source and the actual ambient temperature at the seal might be as low as 121°C to 149°C (250°F to 300°F).

A specification for aircraft landing gear bearing seals might call out -54°C to 760°C (-65°F to 1400°F), yet the bearing grease to be sealed becomes so viscous at -54°C (-65°F) it cannot possibly leak out. At the high end, there is a time-temperature relationship in the landing rollout that allows rapid heat dissipation through the magnesium wheel housing on which the seals are mounted. This, combined with low thermal conductivity of the seal, limits heat input to the seal so that temperature may never exceed 71°C (160°F). As a result, a more realistic temperature range would be -34°C to 82°C (-30°F to 180°F).

Parker has applied a realistic temperature range with a margin of safety when setting the general operating temperature range for seal compounds. The maximum temperature recommendation for a compound is based on

long term functional service. If it is subjected to this temperature continuously, it should perform reliably for 1,000 hours. Time at less than maximum temperature will extend life. Similarly, higher temperature will reduce it.

The high temperature limits assigned to compounds in Figure 2-25 are conservative estimates of the maximum temperature for 1,000 hours of continuous service in the media the compounds are most often used to seal. Since the top limit for any compound varies with the medium, the high temperature limit for many compounds is shown as a range rather than a single figure. This range may be reduced or extended in unusual fluids.

Since some fluids decompose at a temperature lower than the maximum temperature limit of the elastomer, the temperature limits of both the seal and the fluid must be considered in determining limits for a system.

Low temperature service ratings in the past have been based on values obtained by ASTM Test Methods D736 and D746. Currently, Method D2137 is in wide use. The present ASTM D2000 SAE 200 specification calls for the ASTM D2137 low temperature test. For O-rings and other compression seals, however, the TR-10 value per ASTM D1329 provides a better

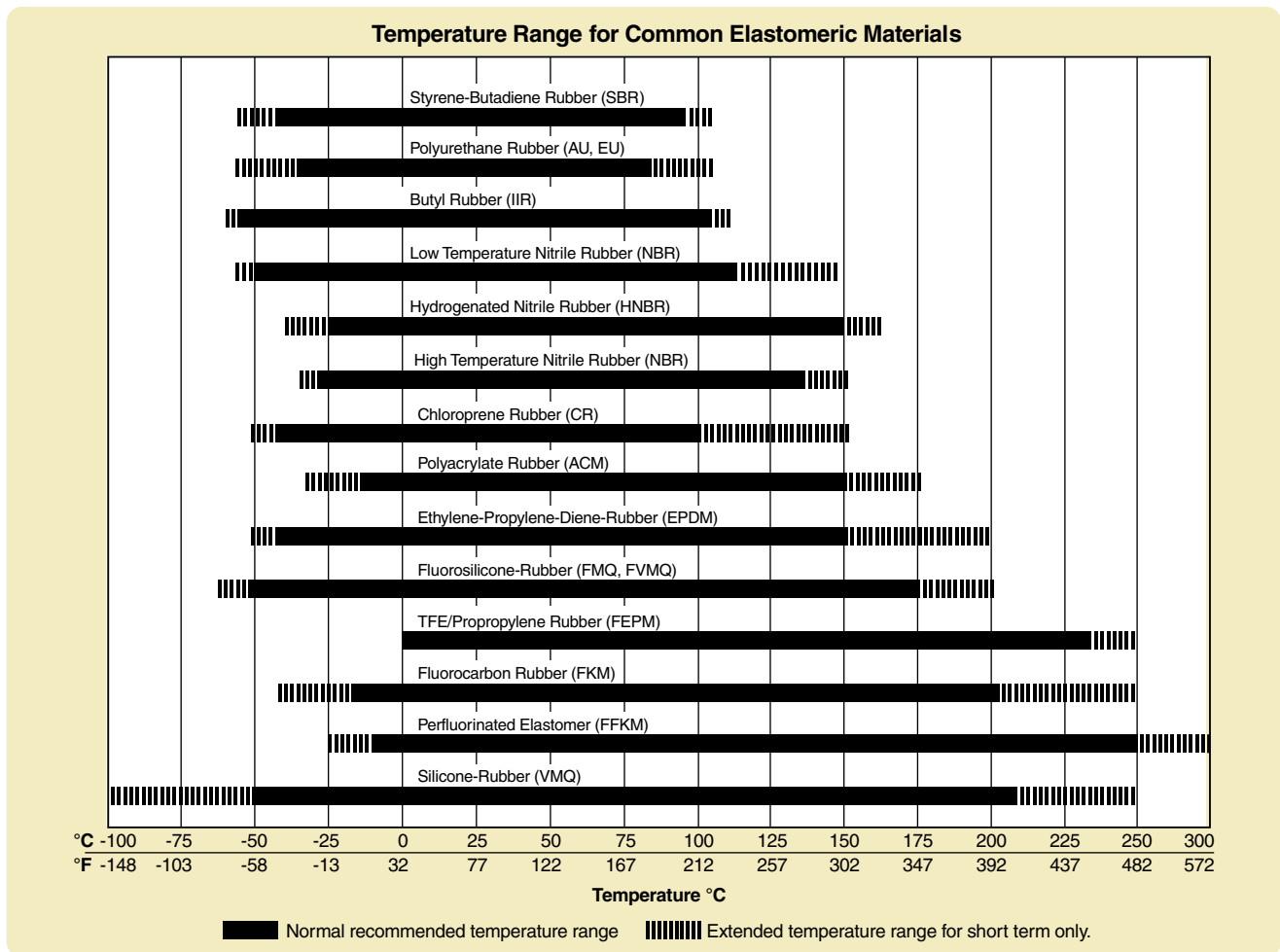

Figure 2-25: Temperature Capabilities of Principal Elastomers Employed in Seals

WARNING: These products can expose you to chemicals including carbon black (airborne and extracts), antimony trioxide, titanium dioxide, silica (crystalline), di(2-ethylhexyl) phthalate, ethylene thiourea, acrylonitrile, 1,3-butadiene, epichlorohydrin, toluenediisocyanate, tetrafluoroethylene, ethylbenzene, formaldehyde, furfuryl alcohol, glass fibers, methyl isobutyl ketone, nickel (metallic and compounds), lead and lead compounds which are known to the State of California to cause cancer; and 1,3-butadiene, epichlorohydrin, di(2-ethylhexyl)phthalate, di-isodecyl phthalate, ethylene thiourea, methyl isobutyl ketone, methanol, toluene, lead and lead compounds which are known to the State of California to cause birth defects and other reproductive harm. For more information go to www.P65Warnings.ca.gov.

means of approximating the low temperature capability of an elastomer compression seal. The low temperature sealing limit is generally about 8°C (15°F) below the TR-10 value. This is the formula that has been used, with a few exceptions, to establish the recommended low temperature limits for Parker Seal Group compounds shown in Figure 2-25 and the Fluid Compatibility Tables in Section VII. This is the lowest temperature normally recommended for static seals. In dynamic use, or in static applications with pulsing pressure, sealing may not be accomplished below the TR-10 temperature, or approximately 8°C (15°F) higher than the low-limit recommendation in the Parker Handbook.

These recommendations are based on Parker tests. Some manufacturers use a less conservative method to arrive at low temperature recommendations, but similar compounds with the same TR-10 temperature would be expected to have the same actual low temperature limit regardless of catalog recommendations.

A few degrees may sometimes be gained by increasing the squeeze on the O-ring section, while insufficient squeeze may cause O-ring leakage before the recommended low temperature limit is reached.

The low temperature limit on an O-ring seal may be compromised if the seal is previously exposed to extra high temperature or a fluid that causes it to take a set, or to a fluid that causes the seal compound to shrink. Conversely, the limit may be lowered significantly if the fluid swells the compound. See Figure 2-26.

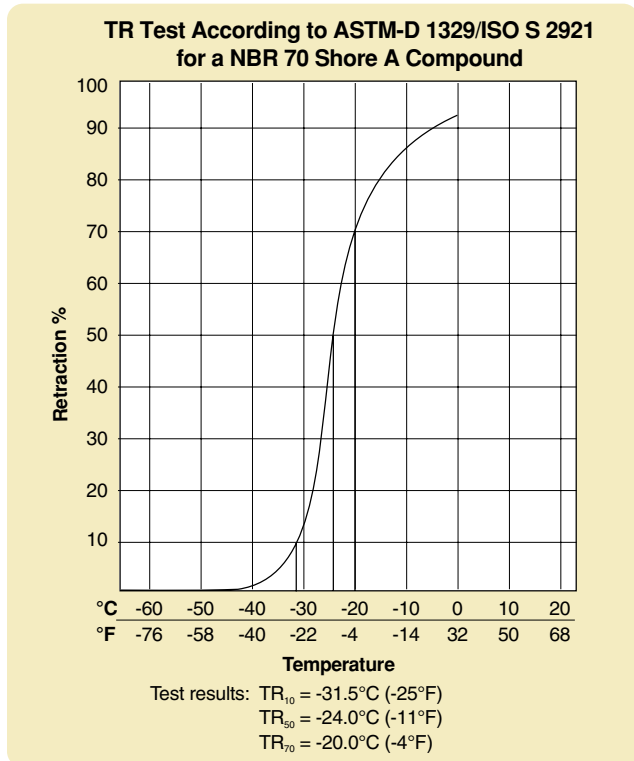

Figure 2-26: TR Test According to ASTM-D 1329/ISO S2921 for a NBR 70 Shore A Compound

With decreasing temperature, elastomers shrink approximately ten times as much as surrounding metal parts. In a rod type assembly, whether static or dynamic, this effect causes the sealing element to hug the rod more firmly as the temperature goes down. Therefore, an O-ring may seal below the recommended low temperature limit when used as a rod type seal.

When excessive side loads are encountered on maximum tolerance rods or glands, and the pressure is in the low range, leakage may occur at temperatures 5° or 8°C (10° or 15°F) above the TR-10 value. It may be necessary to add as much as 22°C (40°F) to the low temperature shown in the tables for this type of service. See Figure 2-27.

2.13.3 Time

The three obvious “dimensions” in sealing are fluid, temperature, and pressure. The fourth dimension, equally important, but easily overlooked, is time.

Up to this point, temperature limits, both high and low, have been published at conventional short-term test temperatures. These have little bearing on actual long-term service of the seal in either static or dynamic applications. A comparison of the temperature limits of individual compounds in this guide with previous literature will reveal that for comparable materials the upper temperature limit is more conservatively expressed. The narrower temperature range does not imply that the compounds discussed are inferior to others. Rather, those high temperature values based on continuous seal reliability for 1,000 hours are being recommended.

As illustrated by the graph (Figure 2-28), short term or intermittent service at higher temperatures can be handled by these materials.

For example, an industrial nitrile (Buna-N) compound, N0674-70, is recommended to only 121°C (250°F), yet it is known to seal satisfactorily for five minutes at 538°C (1,000°F) and at 149°C (300°F) for 300 hours. Therefore, when the application requires a temperature higher than that recommended in the compound and fluid tables, check the temperature curve to determine if the total accumulated time at high temperature is within the maximum allowable limit. The sealing ability of a compound deteriorates with total accumulated time at temperature. The curves show the safe, cumulative time at a given temperature for specific elastomers used as static seals. For dynamic seal applications, temperatures as much as 14°C (25°F) below those indicated may be more realistic.

2.13.4 Pressure

The system operating pressure is always a consideration as it effects the choice of seal materials in several ways. First is hardness, as may be required to resist extrusion in dynamic designs or where there is a large gap between sealed members in static applications. Second is at-rest vs operating conditions and requirements for “leakless” at rest conditions which would suggest due consideration be given to the long-term compression set properties of a given material.



WARNING: These products can expose you to chemicals including carbon black (airborne and extracts), antimony trioxide, titanium dioxide, silica (crystalline), di(2-ethylhexyl) phthalate, ethylene thiourea, acrylonitrile, 1,3-butadiene, epichlorohydrin, toluenediisocyanate, tetrafluoroethylene, ethylbenzene, formaldehyde, furfuryl alcohol, glass fibers, methyl isobutyl ketone, nickel (metallic and compounds), lead and lead compounds which are known to the State of California to cause cancer; and 1,3-butadiene, epichlorohydrin, di(2-ethylhexyl)phthalate, di-isodecyl phthalate, ethylene thiourea, methyl isobutyl ketone, methanol, toluene, lead and lead compounds which are known to the State of California to cause birth defects and other reproductive harm. For more information go to www.P65Warnings.ca.gov.

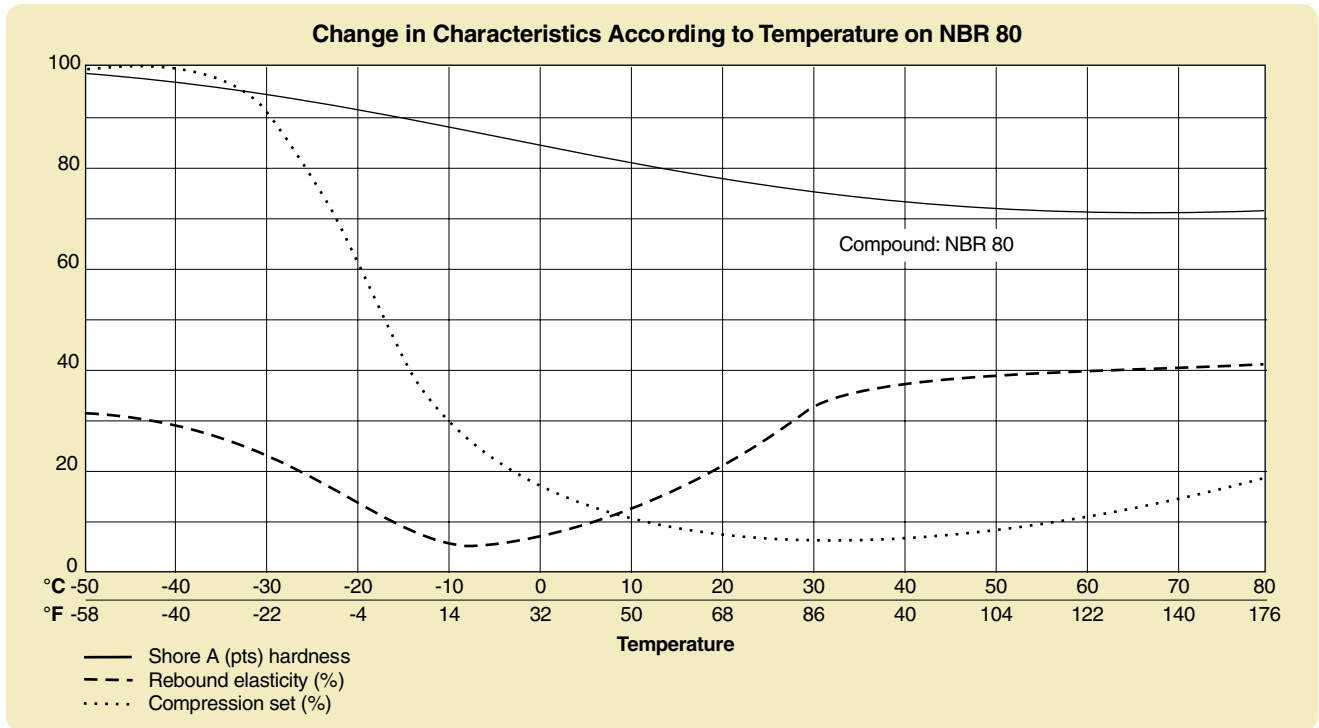

Figure 2-27: Change in Characteristics According to Temperature on NBR 80

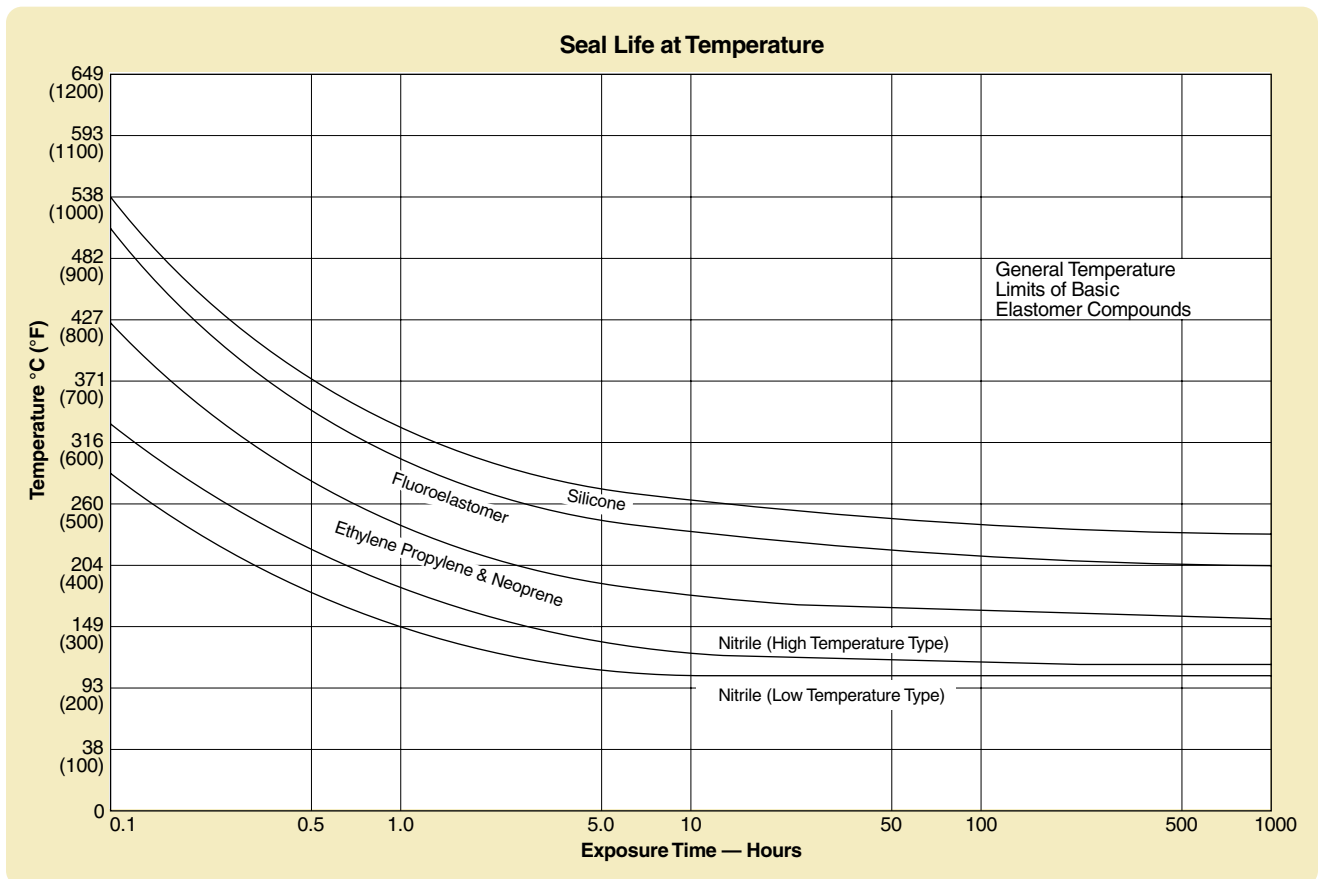

Figure 2-28: Seal Life at Temperature

WARNING: These products can expose you to chemicals including carbon black (airborne and extracts), antimony trioxide, titanium dioxide, silica (crystalline), di(2-ethylhexyl) phthalate, ethylene thiourea, acrylonitrile, 1,3-butadiene, epichlorohydrin, toluenediisocyanate, tetrafluoroethylene, ethylbenzene, formaldehyde, furfuryl alcohol, glass fibers, methyl isobutyl ketone, nickel (metallic and compounds), lead and lead compounds which are known to the State of California to cause cancer; and 1,3-butadiene, epichlorohydrin, di(2-ethylhexyl)phthalate, di-isodecyl phthalate, ethylene thiourea, methyl isobutyl ketone, methanol, toluene, lead and lead compounds which are known to the State of California to cause birth defects and other reproductive harm. For more information go to www.P65Warnings.ca.gov.

2.13.5 Mechanical Requirements

An important consideration in selecting the proper seal material should be the nature of its mechanical operation, i.e. reciprocating, oscillating, rotating, or static. How the seal functions will influence the limitations on each of the parameters (fluids, temperature, pressure, and time) previously discussed.

Static applications require little additional compound consideration. The prime requisite of a static seal compound is good compression set resistance.

Dynamic applications, due to movement, are more involved. All properties must approach the optimum in a dynamic seal compound, resilience to assure that the seal will remain in contact with the sealing surface, low temperature flexibility to compensate for thermal contraction of the seal, extrusion resistance to compensate for wider gaps which are encountered in dynamic glands, and abrasion resistance to hold to a minimum the wearing away or eroding of the seal due to rubbing.

2.14 Selecting a Compound

Having discussed the major aspects of seal design that affect compound selection, here is a summary of the necessary steps to follow, always keeping in mind that standard compounds should be used wherever possible for availability and minimum cost.

1. If military fluid or rubber specifications apply, select the compound from Table 8-2 or 8-3 in Section VIII, Specifications.
2. For all other applications, locate all fluids that will come in contact with the seal in the Fluid Compatibility Tables in Section VII.
3. Select a compound suitable for service in all fluids, considering the mechanical (pressure, dynamic, static) and temperature-time requirements of the application.
4. If a compound of different durometer from that listed in the Fluid Compatibility Tables in Section VII must be used, contact the O-Ring Division for a harder or softer compound in the same base polymer.

2.15 Compound Similarity

General purpose O-ring compounds are listed by polymer and Shore A durometer hardness for ease of selection. Note that the last two digits of Parker O-Ring compound numbers indicate this type A hardness. For example, compound E0540-80 is an 80-durometer material. The one exception is compound 47-071, which is a 70-durometer compound.

Butadiene, chlorosulfonated polyethylene, isoprene, natural rubber, and a few other elastomers do not generally perform as well as the listed polymers in seal applications, and Parker does not normally offer O-rings in these materials.

See Table 2-2 for comparison of similar properties by polymer family.

2.16 Testing

An elastomer is seldom under the same confinement conditions when laboratory physical property tests are made as when installed as a seal. The usual compression, lack of tension, and limited room for expansion when installed, all result in a different physical response from what is measured on an identical but unconfined part.

Example:

A silicone compound tested in hydrocarbon fuel in the free state may exhibit 150% swell. Yet seals of such a compound confined in a gland having volume only 10% larger than the seal, may well perform satisfactorily. Complete immersion may be much more severe than an actual application where fluid contact with the seal is limited through design. The service could involve only occasional splash or fume contact with the fluid being sealed. Different parts made from the same batch of compound under identical conditions will give varying results when tested in exactly the same way because of their difference in shape, thickness, and surface to volume relationship (see Figure 2-29). Humidity alone has been found to affect the tensile strength of some compounds.

Correlation between test data and service conditions is not a simple problem; it is an industry-wide problem. Until improvement can be made, manufacturers and users must use the available data to the best of their ability. In essence, it is the misapplication of data, not the measurements, which causes difficulty. However, with data in some other form, such

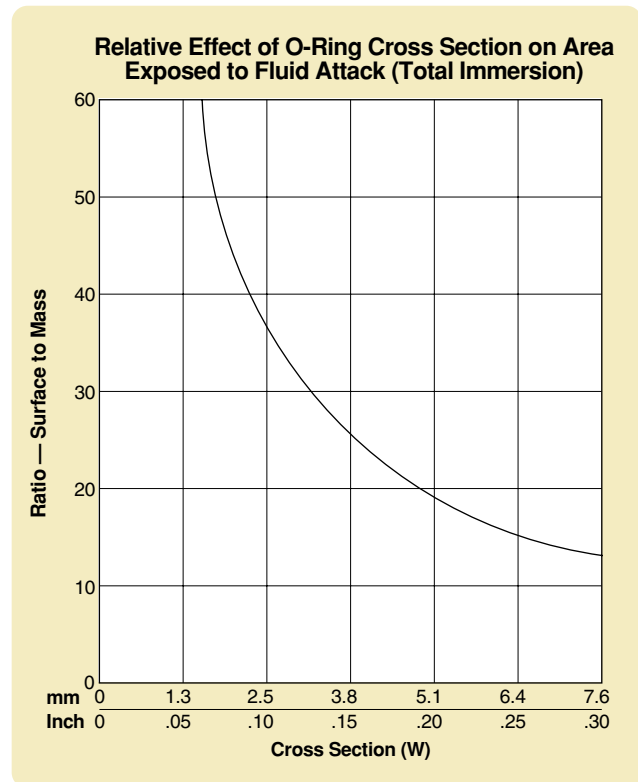

Figure 2-29: Relative Effect of O-ring Cross Section on Area Exposed to Fluid Attack (Total Immersion)



WARNING: These products can expose you to chemicals including carbon black (airborne and extracts), antimony trioxide, titanium dioxide, silica (crystalline), di(2-ethylhexyl) phthalate, ethylene thiourea, acrylonitrile, 1,3-butadiene, epichlorohydrin, toluenediisocyanate, tetrafluoroethylene, ethylbenzene, formaldehyde, furfuryl alcohol, glass fibers, methyl isobutyl ketone, nickel (metallic and compounds), lead and lead compounds which are known to the State of California to cause cancer; and 1,3-butadiene, epichlorohydrin, di(2-ethylhexyl)phthalate, di-isodecyl phthalate, ethylene thiourea, methyl isobutyl ketone, methanol, toluene, lead and lead compounds which are known to the State of California to cause birth defects and other reproductive harm. For more information go to www.P65Warnings.ca.gov.

misapplication might be greatly reduced. ASTM Designation D471 (Standard Method of Test for Change in Properties of Elastomeric Vulcanizates Resulting from Immersion in Liquids) states: "In view of the wide variations often present in service conditions, this accelerated test may not give any direct correlation with service performance. However, the method yields comparative data on which to base judgment as to expected service quality and is especially useful in research and development work."

2.17 Specifications

Specifications are important, but so is progress. Therefore, even though it may be more difficult to prepare, a performance specification is recommended. This allows new developments and improvements to be adopted without any appreciable effect on the specification.

Avoid specifying how to compound materials or process compounds. Let the seal manufacturer examine the performance desired. A vendor should be allowed to supply his best solution to a problem. It is not only possible, but also probable that a well-qualified supplier knows of materials and/or processes that will solve the problem and one should be permitted to use them.

It must be recognized that physical properties provide a means of screening new materials for an application by setting realistic minimums. These can be established when experience with certain properties gives a good indication of the suitability of a new material for the application. These properties also permit control of a material after it has proven satisfactory for an application. Therefore, a brief discussion of the main points

that should be considered when preparing the physical and chemical test portions of a specification follows. The discussion is in the order that specifications are usually written and tests carried out. There are three major points that must always be considered when preparing any specification. These are:

1. Different size parts give different results (see Figure 2-30). All parts with varying cross section or shape will not meet specific properties set up on another particular part or on test specimens cut from a standard 6" x 6" x 0.075" test sheet. Therefore, always designate the actual parts on which the tests are to be conducted for both qualification and control. For example, call for a particular size O-ring if the standard ASTM 6" x 6" x 0.075" test platens are not to be used.
2. Always use standard hardness discs (1.28" dia. = 1 in² by 1/4" thick) or 6" x 6" x 0.075" sheets plied up to a minimum thickness of 1/4" to determine durometer hardness. It has been almost impossible to obtain reliable and reproducible hardness readings on seals with curved surfaces and variable cross sections (such as O-rings). This problem has plagued the industry for years and is acknowledged in both specification and test standards. For example: ASTM Method D2240, paragraph 6-1 states: "A suitable hardness determination cannot be made on a rounded, uneven, or rough surface."
3. It is recommended that standard test methods be used whenever possible. Consider the case of the deviation from the standard methods of taking instantaneous durometer readings. Occasionally, fifteen or thirty second delayed durometer readings are specified. A delayed

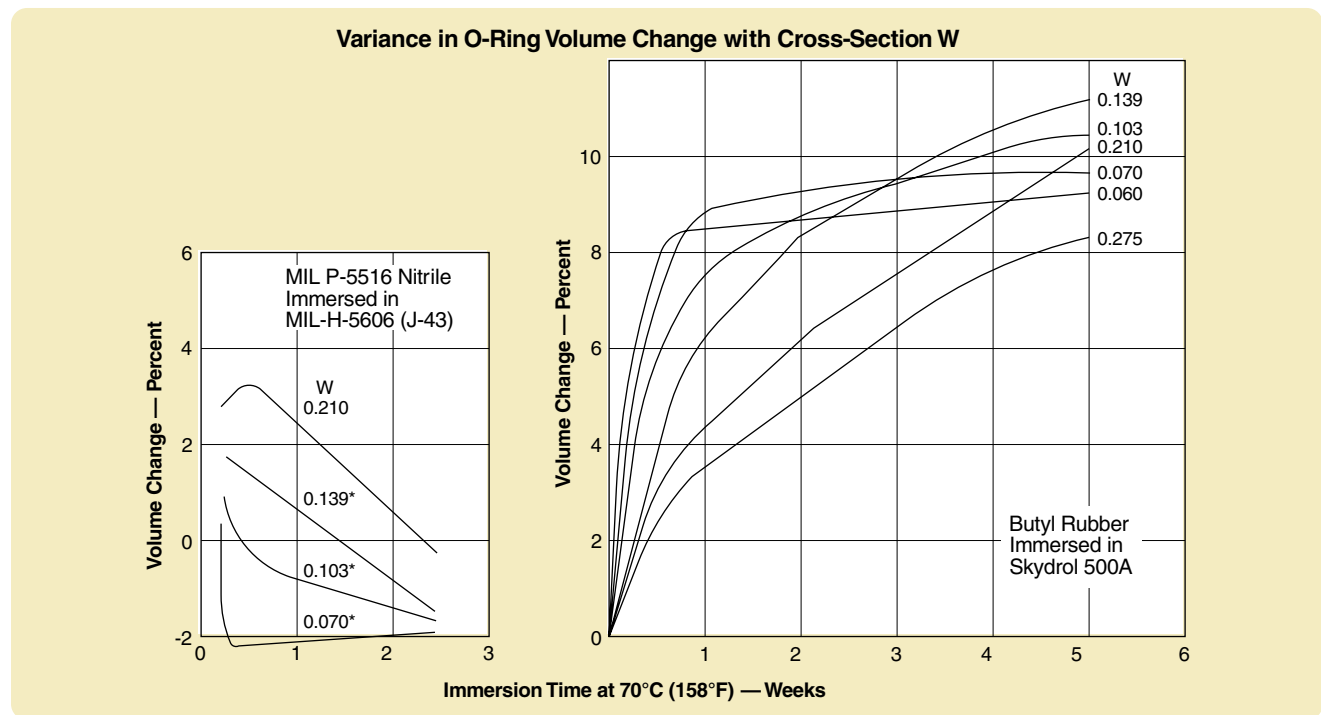

Figure 2-30: Variance in O-ring Volume Change With Cross-Section W
 *Averages of many samples

WARNING: These products can expose you to chemicals including carbon black (airborne and extracts), antimony trioxide, titanium dioxide, silica (crystalline), di(2-ethylhexyl) phthalate, ethylene thiourea, acrylonitrile, 1,3-butadiene, epichlorohydrin, toluenediisocyanate, tetrafluoroethylene, ethylbenzene, formaldehyde, furfuryl alcohol, glass fibers, methyl isobutyl ketone, nickel (metallic and compounds), lead and lead compounds which are known to the State of California to cause cancer; and 1,3-butadiene, epichlorohydrin, di(2-ethylhexyl)phthalate, di-isodecyl phthalate, ethylene thiourea, methyl isobutyl ketone, methanol, toluene, lead and lead compounds which are known to the State of California to cause birth defects and other reproductive harm. For more information go to www.P65Warnings.ca.gov.

durometer reading results in a lower durometer value than would be obtained with the standard instantaneous reading. This usually causes widespread confusion and enlarges the problem of correlation.

Where feasible, designate a standard test method for each test required by a specification (either ASTM or ISO Test Method). These methods are widely used and help to assure correlation among laboratories. Correlation of results is perhaps the hardest thing to assure when preparing a specification. However, adhering to the procedures described above minimizes this problem.

Every well-written specification should contain both qualification and control sections. Although these two sections may be combined in the actual specification, they are discussed separately.

2.18 Qualification Testing

Functional requirements should always be given first. One functional test is worth more than a thousand physical and chemical property tests. The following discussion will lead to a specification for qualification of new seal compounds after the known functional requirements appear to correlate with field or laboratory, chemical or physical results. Thus the first step is to set the original physical property limits that will assure that the mechanical properties desired in the seal are present. These are in addition to the functional tests.

2.18.1 Original Physical Properties

Original Physical Properties (before exposure to service conditions) are those measurable attributes of an elastomer formulation which define certain physical parameters used in determining the suitability of a given elastomer material for a given class of service. Certain of these properties are also used in quality assurance testing to maintain batch control and assure consistency between individual manufacturing lots of compound. Original Physical Properties are also used in limiting/delimiting rubber specifications. These properties are:

a. Durometer

Durometer or Hardness is measured in points with a Shore A instrument. Determine the durometer best suited for the application and round off (50, 65, 70, 85). A standard ± 5 point tolerance is established to allow the vendor a realistic working range and permit normal variations experienced in reading durometer.

b. Tensile Strength

Determine the minimum tensile strength necessary for the application. Always take into consideration the inherent strength of the elastomers most likely to be used to meet the specification (most silicones have tensile strengths in the range of 34.5 to 62.1 Bar (500 to 900 psi); therefore, it would be foolhardy to specify a minimum tensile strength requirement of 138 Bar (2,000 psi) for a silicone material).

Once the minimum tensile strength has been set, multiply it by 1.20 (for example: 69 Bar \times 1.20 = 82.8 Bar (1,000 psi \times 1.20 = 1200 psi)). This is the minimum limit set for tensile strength in the qualification section. It provides for the normal tensile strength variation of $\pm 15\%$ experienced between production batches of a compound.

c. Elongation

Investigate and determine the maximum amount of stretch a seal must undergo for assembly in the application. Multiply this figure by 1.25 to allow a safety factor and to provide for normal production variation of $\pm 20\%$.

d. Modulus

Choose a minimum modulus that will assure a good state of cure, good extrusion resistance, and good recovery from peak loads. Keep in mind the original tensile and elongation figures established in (b.) and (c.). Modulus is directly related to these two properties.

e. Specific Gravity

A value for specific gravity should not be set in the qualification section of the specification but the value should be reported "as determined." This value will then be used in the control section.

2.18.2 Aged Physical Control

The second step is to determine the resistance of the seal to the anticipated service environment. This is done by measuring change in volume and physical properties of test samples after exposure to various conditions for a specified time at a specified temperature (i.e., 70 hours at 100°C (212°F)). Recommended times, temperatures and test fluids for accelerated tests can be found in ASTM D471. It is usually desirable to use the actual service fluid. This does, however, add another variable to the tests since commercial fluids are not as tightly controlled as test fluids. This fluid variation accounts for some of the differences in test results.

a. Hardness Change

This is usually controlled to avoid excessive softening (causing extrusion) or hardening (causing cracking, lack of resilience, and leakage).

b. Tensile Strength Change

Tensile strength change can limit a compounder severely. A reasonable plus or minus limit is usually set as insurance against excessive deterioration and early seal failure. Each individual fluid dictates its own specific limits. For example, a nitrile compound tested in petroleum based IRM 903 (formerly ASTM oil No. 3), at 100°C (212°F), can be expected to lose a maximum of 35% tensile strength and the same compound tested in MIL-L-7808 (di-ester base fluid) can be expected to lose a maximum of 70% tensile strength. Experience will probably dictate the limits. However, a 10% tolerance is never considered realistic since this much variance in tensile strength can be experienced on two test specimens cut from the same sample.



WARNING: These products can expose you to chemicals including carbon black (airborne and extracts), antimony trioxide, titanium dioxide, silica (crystalline), di(2-ethylhexyl) phthalate, ethylene thiourea, acrylonitrile, 1,3-butadiene, epichlorohydrin, toluenediisocyanate, tetrafluoroethylene, ethylbenzene, formaldehyde, furfuryl alcohol, glass fibers, methyl isobutyl ketone, nickel (metallic and compounds), lead and lead compounds which are known to the State of California to cause cancer; and 1,3-butadiene, epichlorohydrin, di(2-ethylhexyl)phthalate, di-isodecyl phthalate, ethylene thiourea, methyl isobutyl ketone, methanol, toluene, lead and lead compounds which are known to the State of California to cause birth defects and other reproductive harm. For more information go to www.P65Warnings.ca.gov.

c. Elongation Change

Experience will dictate this limit as noted under tensile change. Once limits are set, tolerances will apply as discussed in the Control Section on Elongation.

Remember that every designer should set limits for the control of all of these properties based on his past experience in the same or similar application. Excessive hardening, gain of tensile strength, and loss of elongation after immersion are indications of over aging. Excessive softening, loss of tensile strength, and gain of elongation are good indications of reversion toward the original state before cure.

d. Volume Change

1. Determine the maximum amount of swell that can be tolerated in the application (usually 15% to 20% for dynamic and 50% for static).
2. Determine the maximum amount of shrinkage that can be tolerated in the application (usually 3-4% for both dynamic and static). Take into consideration dry-out cycles that may be encountered in service and include a dry-out test after the immersion test to provide a control for dry-out shrinkage. Remember that shrinkage is a prime cause of failure.
3. Set the minimum and maximum limits necessary for control of the volume change of the compound in each fluid that will be encountered in the application, or a representative test fluid.
4. Once again it is necessary to stress the difference between test results on different size seals. For instance, an O-ring with cross-section of .070 inch will not have the same volume swell as will an O-ring of the same compound with a .210 cross-section when tested under the same conditions. Furthermore, this difference is at its peak during the first 70 hours (a popular standard test time) and most accelerated testing is specified within this time period. It sometimes requires longer to approach equilibrium value, depending on time and temperature.

Figure 2-30 shows two graphs that depict these phenomena. Besides the extreme variation among different cross-section O-rings in the first two weeks of testing, notice that .070 section nitrile O-rings swell much less than the .210 section O-rings and that the reverse is true with the butyl compound.

For these reasons, qualification volume swell testing must be limited to definite test samples. A more realistic time (i.e., four or eight weeks depending on the fluid and the elastomer) would give results much more indicative of the stabilized swelling characteristics of a material. Normally neither the customer nor the manufacturer can afford such time for prolonged testing.

Expecting all size seals from a given compound to fall within a set volume swell limit at the most critical time period (70 hours) is unrealistic. Short-term test results are quite useful, but only if their inherent limitations are understood.

e. Compression Set

Compression set is usually measured as the amount that a material fails to recover after compression. A realistic value for compression set is all that is necessary to assure a good state of cure and resilience of a compound. Compression set varies with the elastomer, the type and amount of curing agents, other compounding ingredients in the compound, the temperature of the test, and the thickness of the test specimen. For more information, see "Physical and Chemical Characteristics" earlier in this section (paragraph 2.4).

f. Low Temperature Resistance

Low temperature resistance is measured by determining the flexibility of an elastomer at a given low temperature.

1. The lowest temperature at which the seal is expected to function should be determined.
2. The low temperature test method that most nearly simulates the actual service requirement should be chosen to give the best possible assurance that the seal which passes this test will function in the application. Parker believes that the Temperature Retraction Test (TR-10) is the best method for determining a compound's ability to seal at low temperatures. Most low temperature tests are designed to indicate the brittle point of a material. This only tells at what low temperature the compound is most likely to be completely useless as a seal in a standard design, but very little about the temperature at which it is useful. This is not the case with TR-10 that consists of stretching 3 or 4 samples 50%, freezing them, then warming them gradually at a constant rate, and finally recording the temperature at which the samples have returned to 9/10 of the original stretch (1/10 return). This temperature (TR-10) then is the lowest temperature at which the compound exhibits rubber-like properties and therefore relates to low temperature sealing capabilities. Functional tests indicate that O-rings will usually provide reliable dynamic sealing at or below the TR-10 value. Static O-rings normally function satisfactorily to about -8°C (15°F) below this.

2.19 Process Control

The purpose of process control is to ensure uniformity of purchased parts from lot to lot. Process control may be based on the requirements of the qualification section or actual qualification test results. Both of these methods have inherent weaknesses. When a material is qualified to a specification close to the specification limits, normal production variation may cause the material to fall outside the limits. This could result in unnecessary rejection of good parts. Therefore it is suggested that control be based on actual test results of the material in question.

One should be careful not to be trapped by writing a specification based on one test report having only a single set of values. Any single set of tests made on a particular batch, or laboratory samples, is very unlikely to reflect mean values that can be duplicated day-in and day-out in production. Seal



WARNING: These products can expose you to chemicals including carbon black (airborne and extracts), antimony trioxide, titanium dioxide, silica (crystalline), di(2-ethylhexyl) phthalate, ethylene thiourea, acrylonitrile, 1,3-butadiene, epichlorohydrin, toluenediisocyanate, tetrafluoroethylene, ethylbenzene, formaldehyde, furfuryl alcohol, glass fibers, methyl isobutyl ketone, nickel (metallic and compounds), lead and lead compounds which are known to the State of California to cause cancer; and 1,3-butadiene, epichlorohydrin, di(2-ethylhexyl)phthalate, di-isodecyl phthalate, ethylene thiourea, methyl isobutyl ketone, methanol, toluene, lead and lead compounds which are known to the State of California to cause birth defects and other reproductive harm. For more information go to www.P65Warnings.ca.gov.

manufacturers have accumulated years of test experience on popular, successful compounds. This information is available from Parker on request. With Parker's CBI program it is practical to refer to the batch from which any seal was made, as well as compound statistical capability and history.

Many of the typical tests for determining a compound's physical and chemical properties that are specified in the qualification section are unnecessary to provide good control of an approved material. Discussion will be limited to only those properties really pertinent to the control section of the specifications.

a. Hardness is often specified as a control. It is frequently problematic because of inherent difficulties in measuring durometer with seal specimens rather than standard hardness discs, or platen plies.

A tolerance of ± 5 points is the standard allowance for experimental error caused by reading techniques and production variance from batch to batch of the same compound. This tolerance is sometimes erroneously

applied to the original qualification results. For example, if the qualification section specified 70-durometer ± 5 and the qualification value was a 68-durometer reading, the control section would specify 68 ± 5 . It is more desirable to keep the original qualification hardness and tolerance remain in effect (i.e., both qualification and control values of 70 ± 5). This practice is less likely to result in unnecessary rejection of usable parts.

b. Tensile Strength, a tolerance of $\pm 15\%$ is standard for any given compound. This tolerance was taken into consideration when establishing the tensile strength qualification limit of 1200 psi for dynamic seals (see qualification section, tensile strength). If a part qualified at the minimum, 82.8 Bar (1200 psi), and the control tolerance is applied, it is possible to receive a part with a tensile strength of 70.4 Bar (1020 psi). This value, 70.4 Bar (1020 psi), remains above the (69 Bar (1,000 psi) minimum that is usually required for dynamic applications as previously stated.

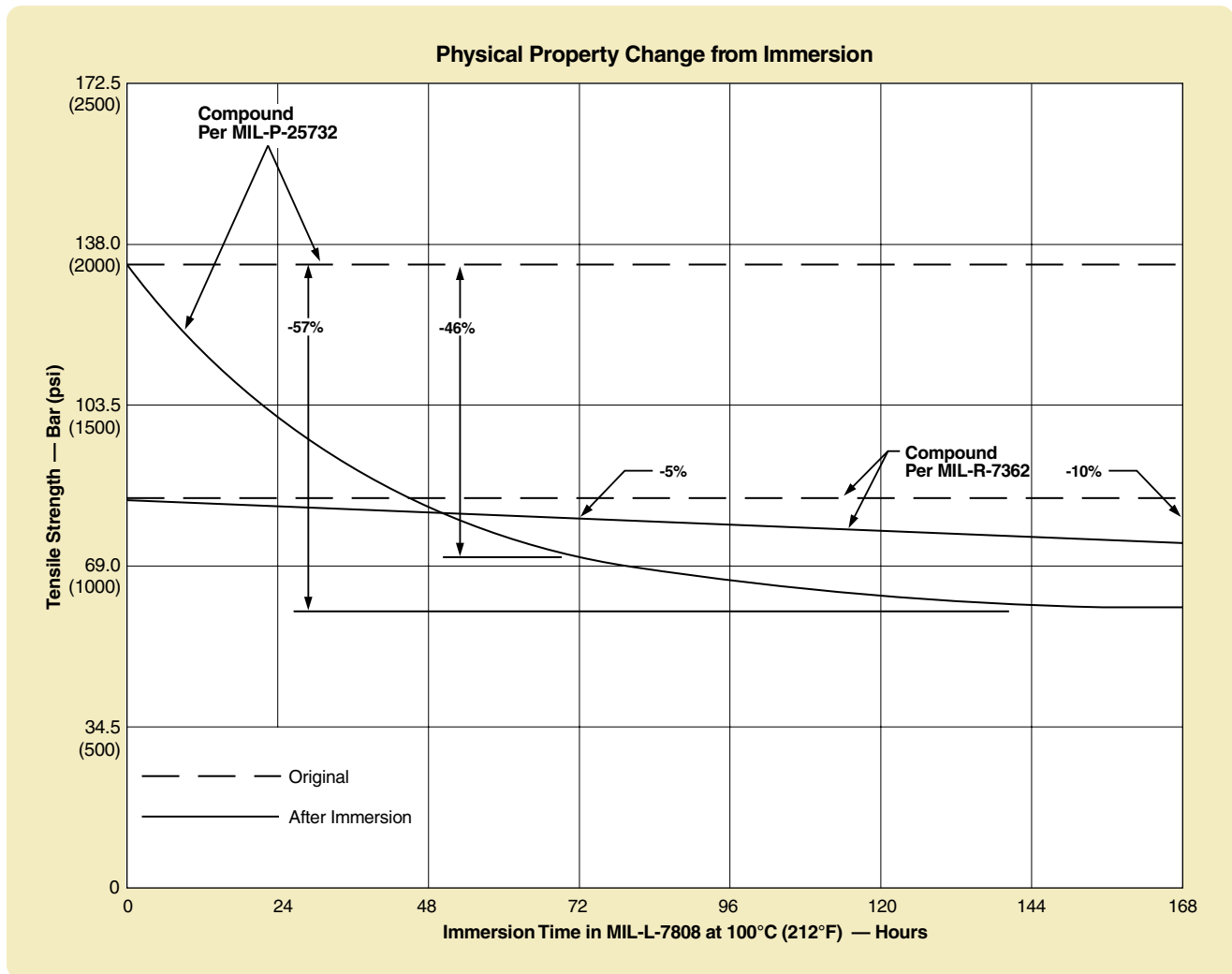

Figure 2-31: Physical Property Change from Immersion

WARNING: These products can expose you to chemicals including carbon black (airborne and extracts), antimony trioxide, titanium dioxide, silica (crystalline), di(2-ethylhexyl) phthalate, ethylene thiourea, acrylonitrile, 1,3-butadiene, epichlorohydrin, toluenediisocyanate, tetrafluoroethylene, ethylbenzene, formaldehyde, furfuryl alcohol, glass fibers, methyl isobutyl ketone, nickel (metallic and compounds), lead and lead compounds which are known to the State of California to cause cancer; and 1,3-butadiene, epichlorohydrin, di(2-ethylhexyl)phthalate, di-isodecyl phthalate, ethylene thiourea, methyl isobutyl ketone, methanol, toluene, lead and lead compounds which are known to the State of California to cause birth defects and other reproductive harm. For more information go to www.P65Warnings.ca.gov.

- c. **Elongation**, a tolerance of $\pm 20\%$ is standard. Again this must be taken into consideration as part of the safety factor, when setting a limit for elongation for qualification.
- d. **Modulus**, a tolerance of $\pm 20\%$ is standard but is seldom used for control.
- e. **Specific Gravity** of a compound having been established during qualification, a tolerance of $\pm .02$ may be applied. Specific gravity is the easiest and quickest control test available to the industry today. It is also the most accurate if the stringent $\pm .02$ tolerance is applied. Specific gravity is the only test some purchasers use.
- f. **Volume Change**, a plus or minus tolerance on this property is frequently unrealistic. A combination of variance in commercial fluids and sample size gives such an accumulation of negative factors that it is not always feasible to use volume swell as a control. It can be done if, (1) a controlled test fluid is used or control of the commercial fluid eliminates its variance, (2) time of the test is extended, (3) a volume swell history over a long period of time is established on every seal on which a check is desired, and (4) when testing small size seals multiple samples are used for each weighing, thus minimizing inaccuracy (for example: if the balance being used is accurate to .01 gram and a small seal with a weight of .03 gram is being tested, it is easy to see where a result on this size seal can be extremely inaccurate).

If controls are established for the above properties and a compound complies, specifying additional tests is not necessary.

Guard against specifying unrealistically high physical properties that may in reality be detrimental to a seal due to the greater percentage drop-off of these properties after short periods of exposure to fluids (see Figure 2-31). In many applications, a compound in accordance with MIL-R-7362 has outperformed MIL-P-25732 material at both high and low temperature.

Remember, building in too much of a safety factor in the specification can lead to costs that are prohibitive because the best looking laboratory reports are desired. If the compounder is forced to develop a material that is extremely difficult to process, manufacturing costs will increase due to higher scrap rates. The customer ultimately bears these costs.

Each seal supplier has developed numerous nitrile compounds to meet various specifications, all written to accomplish the same thing — to obtain a seal suitable for use with a petroleum base hydraulic fluid. The result is different compounds available for the same service, any one of which would perform satisfactorily in almost all the applications.

Only the more common physical and chemical property tests have been discussed. When preparing a specification and in need of assistance, please call on a Parker Seal representative in your area. They will be more than happy to help you.

WARNING: These products can expose you to chemicals including carbon black (airborne and extracts), antimony trioxide, titanium dioxide, silica (crystalline), di(2-ethylhexyl) phthalate, ethylene thiourea, acrylonitrile, 1,3-butadiene, epichlorohydrin, toluenediisocyanate, tetrafluoroethylene, ethylbenzene, formaldehyde, furfuryl alcohol, glass fibers, methyl isobutyl ketone, nickel (metallic and compounds), lead and lead compounds which are known to the State of California to cause cancer; and 1,3-butadiene, epichlorohydrin, di(2-ethylhexyl)phthalate, di-isodecyl phthalate, ethylene thiourea, methyl isobutyl ketone, methanol, toluene, lead and lead compounds which are known to the State of California to cause birth defects and other reproductive harm. For more information go to www.P65Warnings.ca.gov.

Basic O-Ring Elastomers



WARNING: These products can expose you to chemicals including carbon black (airborne and extracts), antimony trioxide, titanium dioxide, silica (crystalline), di(2-ethylhexyl) phthalate, ethylene thiourea, acrylonitrile, 1,3-butadiene, epichlorohydrin, toluenediisocyanate, tetrafluoroethylene, ethylbenzene, formaldehyde, furfuryl alcohol, glass fibers, methyl isobutyl ketone, nickel (metallic and compounds), lead and lead compounds which are known to the State of California to cause cancer; and 1,3-butadiene, epichlorohydrin, di(2-ethylhexyl)phthalate, di-isodecyl phthalate, ethylene thiourea, methyl isobutyl ketone, methanol, toluene, lead and lead compounds which are known to the State of California to cause birth defects and other reproductive harm. For more information go to www.P65Warnings.ca.gov.

Section III – O-Ring Applications

3.0 Introduction	3-2	3.9.13 Nuclear Technology	3-14
3.1 Factors Applying to All O-Ring Types	3-2	3.9.14 Radiation	3-14
3.1.1 Compatibility	3-2	3.9.15 Energy, Oil and Gas	3-14
3.1.2 Temperature	3-3	3.9.16 Fungus-Resistant Compounds	3-15
3.1.3 Pressure	3-3	3.9.17 Hydraulic Fluids	3-15
3.1.4 Extrusion	3-3	3.9.17.1 Fire-Resistant Hydraulic Fluids	3-15
3.1.5 Lubrication	3-4	3.9.17.1.1 HFA Fluids	3-15
3.1.5.1 Parker O-Lube	3-4	3.9.17.2 Concentrates Containing	
3.1.5.2 Parker Super-O-Lube	3-4	Mineral Oils (Oil-in-Water-Solutions)	3-17
3.1.5.3 PTFE Coatings	3-5	3.9.17.3 Micro-Emulsions	3-17
3.1.5.4 Other Friction Reduction Methods	3-5	3.9.17.4 Synthetic HFA	
3.1.5.5 Internal Lubrication	3-5	Concentrates (Solutions)	3-17
3.1.6 Accessories	3-6	3.9.17.5 HFC Fluids	3-17
3.1.6.1 Extraction Tools	3-6	3.9.17.6 HFD Fluids	3-17
3.1.6.2 O-Ring Sizing Cone	3-6	3.10 Temperature Extremes	3-17
3.1.6.3 O-Ring Kits	3-6	3.10.1 High Temperature	3-17
3.2 Cleanliness	3-7	3.10.2 Low Temperature	3-18
3.3 Assembly	3-7	3.11 Vacuum Applications	3-19
3.4 Selecting the Best Cross-Section	3-7	3.11.1 Vacuum Weight Loss	3-19
3.5 Stretch	3-8	3.11.2 Vacuum Seal Considerations	3-19
3.6 Squeeze	3-9	3.11.3 Vacuum Leak Rate	3-20
3.7 Gland Fill	3-9	3.12 Gases-Permeability	3-20
3.8 O-Ring Compression Force	3-9	3.12.1 Leak Rate Approximation	3-21
3.9 Specific Applications	3-10	3.13 Gases-High Pressure	3-21
3.9.1 Automotive	3-10	3.14 Acids	3-22
3.9.2 Engine	3-10	3.14.1 Plastic Contact Surfaces	3-22
3.9.3 Brake System	3-10	3.14.2 Silicone Fluids	3-22
3.9.4 Fuel System	3-10	3.14.3 Underwriters' Laboratories	3-22
3.9.5 Fuels for Automobile Engines	3-11	3.14.4 Water and Steam Resistance	3-22
3.9.6 Transmission	3-11	3.15 Semiconductor	3-24
3.9.7 Cooling & Heating Systems	3-11	3.16 inPHorm Seal Design and	
3.9.8 Air Conditioning	3-12	Material Selection Software	3-24
3.9.9 Power Steering Systems	3-12	3.17 Drive Belts	3-24
3.9.10 Refrigeration and Air Conditioning	3-12	3.17.1 Introduction	3-24
3.9.11 Food, Beverage and Potable Water	3-12	3.17.2 Drive Belt Compound Selection	3-24
3.9.12 Aerospace Technology	3-13	3.17.3 Available Drive Belt Compounds	3-24
3.9.12.1 Jet Fuels	3-13	3.18 Applications Summary	3-25
3.9.12.2 Liquid Rocket Propellants	3-13		

WARNING: These products can expose you to chemicals including carbon black (airborne and extracts), antimony trioxide, titanium dioxide, silica (crystalline), di(2-ethylhexyl) phthalate, ethylene thiourea, acrylonitrile, 1,3-butadiene, epichlorohydrin, toluenediisocyanate, tetrafluoroethylene, ethylbenzene, formaldehyde, furfuryl alcohol, glass fibers, methyl isobutyl ketone, nickel (metallic and compounds), lead and lead compounds which are known to the State of California to cause cancer; and 1,3-butadiene, epichlorohydrin, di(2-ethylhexyl)phthalate, di-isodecyl phthalate, ethylene thiourea, methyl isobutyl ketone, methanol, toluene, lead and lead compounds which are known to the State of California to cause birth defects and other reproductive harm. For more information go to www.P65Warnings.ca.gov.

O-Ring Applications

3.0 Introduction

In designing an O-ring seal, it is best to determine the O-ring compound first, as the selected compound may have significant influence on gland design parameters.

Essentially, the application determines the rubber compound; the primary factor being the *fluid* to be sealed. The elastomer however, must also resist *extrusion* when exposed to the maximum anticipated system pressure and be capable of maintaining good physical properties through the full *temperature* range expected. In dynamic applications, the selected material must also have the *toughness* and *abrasion* resistance so important in reciprocating and rotary seals.

The Fluid Compatibility Tables in Section VII suggest potential Parker Compounds for over two thousand different gases, fluids and solids. Normally, the “Recommended Parker O-Ring Compound” indicated in the tables should be the one specified for initial testing and evaluation.

In some instances, where there are two or more fluids to be sealed, it may be necessary to compromise on a seal material having the best overall resistance to all the fluids involved. Whenever possible this should be a compound rated “1” for all the fluids under consideration. For a static seal application, a “2” rating is usually acceptable, but it should, in all cases, be tested. Where a “2” rated compound must be used, do not expect to re-use it after disassembly. It may have degraded enough that it cannot safely be reinstalled.

When a compound rated “3” is selected, be certain it is first thoroughly tested under the full range of anticipated operating conditions. Some of these 3-rated compounds may prove to be satisfactory as static seals, but many will not.

Note the operating temperature range of the chosen compound. The temperatures shown in Table 7-1 are general temperature ranges, but the presence of a particular fluid may modify the published limits. Remember, only appropriate testing can safely determine an acceptable O-ring seal material.

If a compound designated “Static only” is the only compound recommended for the fluids, and the application is dynamic, the compound may nevertheless be suitable in some unique situations. Bear in mind that “Static only” compounds are not as tough and abrasion resistant as other materials, and would normally wear more rapidly in a dynamic environment.

If the anticipated seal motion is infrequent, or if the seal can be replaced often, a “Static only” compound will probably be satisfactory.

If, for some reason a compound of different shore hardness from the one suggested in the Fluid Compatibility Table is needed, compounds of other hardnesses in the same polymer are available. Contact the O-Ring Division.

When two or more compounds are suitable for a given application, price and stock availability may become determining factors. Current piece-price and in-stock availability can be obtained from your nearest Authorized Parker O-Ring Distributor.

Following this introduction are discussions on a number of special applications that require additional attention. It is recommended that the designer consult the applications listed and read carefully any of those paragraphs which apply to his application.

3.1 Factors Applying to All O-Ring Types

For the majority of standard applications, the design of the O-ring seal has generally already been accomplished. The necessary data for gland dimensions are simply selected from the tables in the sections on Static and Dynamic O-Ring Sealing, Sections IV and V, respectively. The value of making a detailed comparison between previously satisfactory installations and a new one cannot be over-emphasized. Such comparison should disclose any weak points where modification may be desirable or required, thus simplifying the process and facilitating the design effort.

The following paragraphs discuss the more important design factors that generally apply to all O-ring seals. Data and procedures enabling the designer to depart from the standard designs in order to meet peculiar requirements, or to obtain improved performance from the seal will also be found in this section.

Specific design and dimensional data applicable to static seals is provided in the Static O-Ring Sealing Section (IV), and information on dynamic seals is contained in the Dynamic O-Ring Sealing Section (V).

3.1.1 Compatibility

Compatibility between the O-ring and the fluid or fluids to be sealed must be the first consideration in the design process. If the fluid will have an *immediate* adverse effect (chemical reaction resulting in surface destruction, loss of strength, degradation, or other marked change in physical properties) resulting in shortened seal life, there is little advantage to be gained by proceeding further with the design until this basic problem is resolved.

If more than one fluid is involved, both the sequence of exposure and time of contact with the O-ring need be considered. If compatibility cannot be determined from specific data in this section or the Fluid Compatibility Tables in Section VII, refer the problem to your Parker Field Engineer, Parker O-Ring Distributor or contact the Application Engineering Department of the Parker O-Ring Division at (859) 269-2351.



WARNING: These products can expose you to chemicals including carbon black (airborne and extracts), antimony trioxide, titanium dioxide, silica (crystalline), di(2-ethylhexyl) phthalate, ethylene thiourea, acrylonitrile, 1,3-butadiene, epichlorohydrin, toluenediisocyanate, tetrafluoroethylene, ethylbenzene, formaldehyde, furfuryl alcohol, glass fibers, methyl isobutyl ketone, nickel (metallic and compounds), lead and lead compounds which are known to the State of California to cause cancer; and 1,3-butadiene, epichlorohydrin, di(2-ethylhexyl)phthalate, di-isodecyl phthalate, ethylene thiourea, methyl isobutyl ketone, methanol, toluene, lead and lead compounds which are known to the State of California to cause birth defects and other reproductive harm. For more information go to www.P65Warnings.ca.gov.

3.1.2 Temperature

Operating temperature, or more properly, the *range* of system temperature, may require some minor modification of the gland design. Gland dimensions given in the static and dynamic seal design sections are calculated for the temperature ranges listed for standard compounds. If the operation is *only* to be at a high temperature, gland volume may need to be increased to compensate for thermal expansion of the O-ring. Conversely, for operation only at low temperature, a better seal may result by reducing the gland depth, thereby obtaining the proper squeeze on the contracted O-ring. Table 2-4, which lists the approximate rate of linear thermal expansion for typical elastomers and other materials, may be utilized to calculate compensated gland dimensions. For either high or low temperature seal designs, however, there must normally be sufficient squeeze to prevent leakage at room temperature. Figure 3-1 illustrates another possible type of design to improve low temperature sealing capability by spring loading the O-ring.

Such special designs for high and low temperature environments are seldom required. The minimum squeeze values for the various O-ring cross-section diameters given in the design charts of the static and dynamic seal design sections are generally satisfactory.

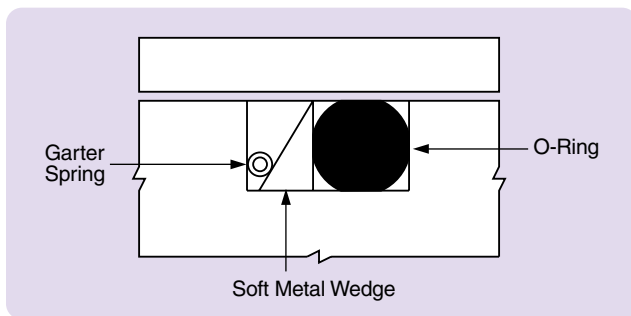

Figure 3-1: Spring-Loading for Low Temperature

3.1.3 Pressure

Pressure has a bearing on O-ring seal design as it can affect the choice of compound shore hardness. At very low pressures, proper sealing may be more easily obtained with lower durometer hardness (50-60 shore A). With higher pressures, the combination of pressure and material shore hardness determine the maximum clearance that may safely be tolerated (see Figure 3-2). Cyclic fluctuation of pressure can cause local extrusion of the O-ring resulting in “nibbling” (see Section X, Failure Modes), particularly if peak system pressures are high enough to cause expansion of the cylinder wall. One remedy may be to stiffen the cylinder to limit the expansion so that the bore to piston clearance does not exceed a safe value.

3.1.4 Extrusion

Extrusion of O-rings may also be prevented by the use of anti-extrusion (back-up) devices. These are thin rings of much harder material fitted into the gland between the seal and the clearance gaps, which essentially provide zero clearance. They are available in hard elastomer compounds, leather, PTFE, Nylon and other similar materials. Parker Parbaks® are elastomer back-up rings and are generally recommended based on their proven functional superiority. The exact point at which it becomes necessary to use anti-extrusion devices will depend on the pressure, type of elastomer being used, its Shore hardness, the size of the clearance gap, and the degree of “breathing” of the metal parts which will be encountered. Figure 3-2 may be used as a guide in determining whether or not anti-extrusion rings should be used. When using the data, include in the diametral clearance any “breathing,” or expansion of the cylinder bore that may be anticipated due to pressure. Although based on data obtained from O-rings, the ninety durometer curve can also be used as a guide to back-up ring performance. The Parbak Back-Up Rings Section (VI), describes in greater detail Parker Parbak back-up rings, and provides size and part number data. Also see “Patterns of O-Ring Failure” in Section IX for more information on extrusion.

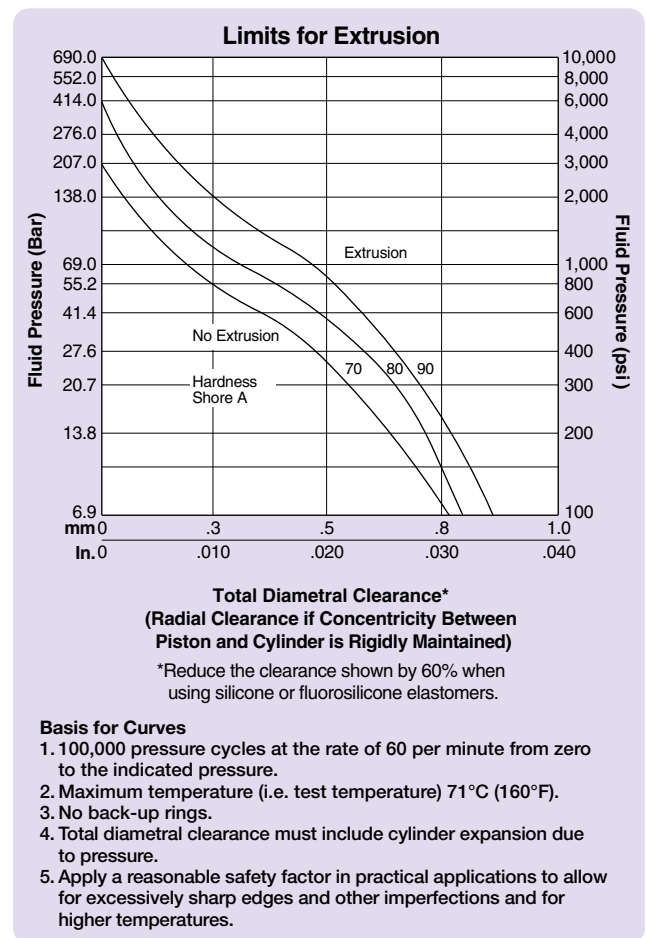

Figure 3-2: Limits for extrusion

WARNING: These products can expose you to chemicals including carbon black (airborne and extracts), antimony trioxide, titanium dioxide, silica (crystalline), di(2-ethylhexyl) phthalate, ethylene thiourea, acrylonitrile, 1,3-butadiene, epichlorohydrin, toluenediisocyanate, tetrafluoroethylene, ethylbenzene, formaldehyde, furfuryl alcohol, glass fibers, methyl isobutyl ketone, nickel (metallic and compounds), lead and lead compounds which are known to the State of California to cause cancer; and 1,3-butadiene, epichlorohydrin, di(2-ethylhexyl)phthalate, di-isodecyl phthalate, ethylene thiourea, methyl isobutyl ketone, methanol, toluene, lead and lead compounds which are known to the State of California to cause birth defects and other reproductive harm. For more information go to www.P65Warnings.ca.gov.

3.1.5 Lubrication

Lubrication of O-ring seals is extremely important for installation and operation of dynamic seals as well as proper seating of static seals. The general rule for use of lubrication is: **The greatest benefit in using a lubricant is obtained during the initial installation of the O-ring.**

Lubricants are commonly used on O-rings and other elastomeric seals. Using a suitable grease or oil during assembly helps protect the O-ring from damage by abrasion, pinching, or cutting. It also helps to seat the O-ring properly, speeds up assembly operations, and makes automated assembly line procedures possible. An additional benefit is the protection that the lubricant provides as a surface film. Proper lubrication also helps protect some polymers from degradation by atmospheric elements such as ozone and its presence helps extend the service life of any O-ring. A lubricant is almost essential in pneumatic applications requiring dynamic service. In vacuum applications, appropriate lubricants help reduce the overall leak rate by filling the microfine inclusions of the gland's metal surfaces and lowering permeation rates of the elastomer.

Parker Seal offers two lubricants that will satisfy most service needs: Parker O-Lube and Parker Super O-Lube. These two lubricants are described in the following paragraphs. Table 3-1 lists their key properties along with others used in specific types of services. Table 3-2 provides part number information for O-Lube and Super O-Lube.

Parker O-Ring Lubricants

O-Lube		Super-O-Lube	
Part Number	Description	Part Number	Description
OLUBE	2 gr. tube	SLUBE	2 gr. tube
884-2GRAMS		884-Grams	
OLUBE .25OZ	¼ oz. tube	SLUBE .25OZ	¼ oz. tube
OLUBE 884-.50	½ oz. tube	SLUBE 884-.5	½ oz. tube
OLUBE 884-4	4 oz. tube	SLUBE 884-2	2 oz. tube
OLUBE 884-35	35 lb. pail	SLUBE 884-8	8 lb. can
OLUBE 884-400	400 lb. drum	SLUBE 884-40	40 lb pail

Note: MSDS are available at www.parkerorings.com

Table 3-2: O-Ring Lubricants

3.1.5.1 Parker O-Lube

Parker O-Lube is an outstanding general-purpose grease intended for use with O-ring and other seals in hydrocarbon service. It can also be used in pneumatic service. The useful temperature is from -29°C to 82°C (-20°F to 180°F).

3.1.5.2 Parker Super-O-Lube

Parker Super O-Lube is an all-purpose O-ring lubricant. It is not a grease, but rather a high-viscosity silicone oil. It is especially useful as a seal lubricant. The temperature range is -54°C to 204°C (-65°F to 400°F).

Parker Super O-Lube can be used as an assembly lubricant on all rubber polymers, including silicones. (Note: Silicones require special consideration.) In addition, Parker Super-

Lubricants

Type of Elastomer	Type of Service	Best	Manufacturer	Temp Range °F
NBR, Nitrile	Hydraulic Oils & Fuels Extreme Service Pneumatic Vacuum	O-Lube	Parker	-20 to 180
		Petrolatum	Many	-20 to 180
		Barium Grease	Many	-20 to 300
		Super O-Lube	Parker	-65 to 400
		DC-55	Dow Corning Co.	-65 to 275
		Celvacene	Consolidated Vacuum Corp.	-40 to 200
CR, Neoprene	Hydraulic Oils & Freon® Vacuum	O-Lube	Parker	-20 to 180
		Petrolatum	Many	-20 to 180
		Celvacene	Consolidated Vacuum Corp.	-40 to 200
EPDM	Skydrol® Steam & Hot Water	MCS-352	Aviation Fluid Service Co.	-65 to 300
		Super O-Lube	Parker	-65 to 400
		DC4, DC-7, DC55	Dow Corning Co.	+32 to 350
		Petrolatum	Many	-20 to 300
Silicone	General High Temperature	FS1292	Dow Corning Co.	-20 to 400
		Mil P 37649	Many	-20 to 180
Fluorosilicone	Oil or Fuel High Temperature	Petrolatum	Many	-65 to 350
		Super O-Lube	Parker	-65 to 400
		DC 4 or DC-7	Dow Corning Co.	+32 to 350
		Petrolatum	Many	-20 to 180
Fluorocarbon	Hydraulic Vacuum & High Temperature	Super O-Lube	Parker	-65 to 400
		DC-55	Dow Corning	-65 to 400
		Petrolatum	Many	-20 to 180

Notes: Assembly lubricants should always be used sparingly during application. A light film is all that is required. This is doubly important in cases 1 and 2 below.

- When only a thin film of O-Lube is used for assembly purposes, the assembly may be subject to higher temperatures, with limits determined by the fluid and elastomer being used.
- Use only a thin film of Super-O-Lube on silicone rubber if the temperature will exceed 149°C (300°F).

Table 3-1: Parker O-Ring Lubricants

Freon® is a registered trademark of E.I. du Pont de Nemours & Co.

Skydrol® is a registered trademark of Solutia Inc.



WARNING: These products can expose you to chemicals including carbon black (airborne and extracts), antimony trioxide, titanium dioxide, silica (crystalline), di(2-ethylhexyl) phthalate, ethylene thiourea, acrylonitrile, 1,3-butadiene, epichlorohydrin, toluenediisocyanate, tetrafluoroethylene, ethylbenzene, formaldehyde, furfuryl alcohol, glass fibers, methyl isobutyl ketone, nickel (metallic and compounds), lead and lead compounds which are known to the State of California to cause cancer; and 1,3-butadiene, epichlorohydrin, di(2-ethylhexyl)phthalate, di-isodecyl phthalate, ethylene thiourea, methyl isobutyl ketone, methanol, toluene, lead and lead compounds which are known to the State of California to cause birth defects and other reproductive harm. For more information go to www.P65Warnings.ca.gov.

O-Lube has some unique advantages. It clings tenaciously to rubber or metal surface helping to prevent it from being flushed away by action of the system fluid. It has one of the widest temperature ranges of any seal lubricant available. It can be used for high pressure systems or in **hard vacuum environments**. Super-O-Lube's inert nature lends itself to a wide variety of fluid systems. Since there are no organic fillers, there can be no clogging of microfilters.

In addition to its outstanding performance in internal service, Parker Super-O-Lube gives protection to rubber polymers that are normally age sensitive when exposed to the atmosphere. This is a typical concern with ozone sensitive polymers that require age control.

There are special situations that may exist where one of the two Parker lubricants would **not** be the best recommendation. For instance, there may be a need for a special high vacuum grease, or a lubricant that would be especially suited to phosphate ester service. For guidance in handling these unique situations consult a Parker O-Ring Division Application Engineer.

Before selecting a lubricant (other than the primary fluid being sealed) for use with O-rings, determine that it meets the following requirements:

1. It or any additives that it contains, should not cause shrinkage or excessive swelling of the O-ring compound being used.
2. It should not excessively soften or solidify over the anticipated service temperature range.
3. It should not break-down and leave gummy or gritty deposits after cycling, or show any adverse chemical reaction with the primary fluid being sealed.
4. It should be capable of forming a thin, strong (high surface tension) film over the metal being lubricated that the O-ring's dynamic motion cannot wipe away.
5. It should pass through any filters used in the system.

3.1.5.3 PTFE Coatings

PTFE coatings of O-rings is an ideal low-friction coating where operational flexibility is a major consideration. PTFE also offers additional benefits such as:

- Positive identification at the assembly line
- Ease of installation
- Lower break-in torques
- Reduces costly "hang-ups" on automatic systems
- Lower initial running friction
- Eliminates sticking of components after long storage
- Reduces twisting of rings during installation

The following colors are available: standard blue, medium blue, light blue, white, purple, red, yellow, medium green, dark green, grey, clear, black, orange, brown umber, pink and green/gold.

3.1.5.4 Other Friction Reduction Methods

Besides O-Lube and Super-O-Lube, Parker Seal can supply O-rings that have received various friction reducing treatments. These may include internal lubrication and Parker's Proprietary Lube Treatment. Both are valuable aids for automated assembly operations, and may also be used in many types of applications to reduce friction in service.

Note: While it is always preferable to use a lubricant, keep in mind that there are certain systems in which lubricants would introduce unacceptable contamination, such as semiconductor fabrication and processing equipment or medical and food processing devices.

3.1.5.5 Internal Lubrication

Internal lubrication involves the incorporation of friction reducing ingredients into the elastomer formula. Since this process alters the material's chemistry, Parker's internally lubricated materials are assigned unique compound numbers to differentiate them from their non-lubricated counterparts.

Internal lubricants consist of organic materials such as graphite, molybdenum disulfide, powdered PTFE or, more commonly, a proprietary Parker organic lubricant. Because the lubricant is dispersed throughout the body of an O-ring, this method of friction reduction generally functions longer in service than external lubrication, but to a somewhat lesser degree.

Graphite-impregnated compounds are commonly used to seal rotary shafts. It should not however, be used in contact with stainless steel surfaces because graphite tends to cause corrosive pitting of stainless materials. For such applications, compounds containing molybdenum disulfide are often a successful alternative.

Compound V0848-75 contains powdered PTFE to reduce friction.

Compounds containing this organic lubricant have become quite popular. PTFE migrates through the O-ring and gradually blooms to the surface, prolonging its lubricating effectiveness. It takes a long time to degrade a significant portion of the coating when it is lost only through the mechanical action of the mating surface. Fluids, however, tend to dissolve it, and some solvents can leach out much of the internal lubricant in a short time.

Internally lubricated compounds, where applicable, are available from the O-Ring Division.

WARNING: These products can expose you to chemicals including carbon black (airborne and extracts), antimony trioxide, titanium dioxide, silica (crystalline), di(2-ethylhexyl) phthalate, ethylene thiourea, acrylonitrile, 1,3-butadiene, epichlorohydrin, toluenediisocyanate, tetrafluoroethylene, ethylbenzene, formaldehyde, furfuryl alcohol, glass fibers, methyl isobutyl ketone, nickel (metallic and compounds), lead and lead compounds which are known to the State of California to cause cancer; and 1,3-butadiene, epichlorohydrin, di(2-ethylhexyl)phthalate, di-isodecyl phthalate, ethylene thiourea, methyl isobutyl ketone, methanol, toluene, lead and lead compounds which are known to the State of California to cause birth defects and other reproductive harm. For more information go to www.P65Warnings.ca.gov.

3.1.6 Accessories

3.1.6.1 Extraction Tools

These unique double-ended tools make life easier for those who have to frequently install or remove O-rings from hydraulic or pneumatic cylinders and equipment. They are available in brass or plastic with or without a convenient carrying case.

3.1.6.2 O-Ring Sizing Cone

A unique measuring cone and circumference “Pi” tape provide quick and easy o-ring sizing information to determine the nearest standard Parker o-ring size. Please note: the cone and tape do not measure actual dimensions of a part and cannot be used for pass/fail inspections. See table 3-3 for part number information.

3.1.6.3 O-Ring Kits

When part numbers are missing, seal dimensions are unknown, and the parts themselves are unavailable from the equipment OEM, these o-ring kits can save the day, not to mention hours of downtime. More than eight different standard kits give you a choice of compounds and o-ring sizes for a wide range of sealing applications. The end result? Multiple sealing solutions for the same cost as a single OEM replacement part. We’ll even build custom kits using any of our 200-plus compounds. Please see table 3-4 through table 3-7 for detailed kit information.

O-Ring Extraction Tools and Cone Part Numbers

Part Number	Description
Brass Extraction Kit	Brass extraction pick and spat in plastic pouch
Plastic O-ring Pick	Plastic extraction pick
Plastic Sizing Cone	O-ring sizing kit

Notes: Private labeling is available.

Table 3-3: Extraction Tools and Cone Part Numbers

O-Ring Kits

Part Number	Description
Plastic Std. Kit E0515	Compound E0515-80 EPR 80 durometer O-rings per NAS 1613 rev. 2 in 37 popular AS568 sizes / 513 O-rings
Plastic Std. Kit N0552	Compound N0552-90 NBR 90 durometer O-rings in 37 popular AS568 sizes / 513 O-rings
Plastic Std. Kit N0674	Compound N0674-70 NBR 70 durometer O-rings in 37 popular AS568 sizes / 513 O-rings
Plastic Std. Kit V0747	Compound V0747-75 FKM 75 durometer O-rings in 37 popular AS568 sizes / 513 O-rings
Plastic Std. Kit V0884	Compound V0884-75 FKM (brown) 75 durometer O-rings in 37 popular AS568 sizes / 513 O-rings
N1470 AS568 Kit #1	Compound N1470-70 NBR 70 durometer in 30 popular sizes / 382 O-rings
N1470 Metric Kit #1	Compound N1470-70 NBR 70 durometer in 32 popular metric sizes / 372 O-rings
N1490 Boss Kit	Compound N1490-90 NBR 90 durometer in 20 standard tube fitting sizes

Note: Boxes and plugs are available as separate items.

Table 3-4: O-Ring Kits

AS568 Kit #1 Sizes

Size	Dimensions	Quantity
2-006	0.114 x .070	20
2-007	0.145 x .070	20
2-008	0.176 x .070	20
2-009	0.208 x .070	20
2-010	0.239 x .070	20
2-011	0.239 x .070	20
2-012	0.364 x .070	20
2-110	0.362 x .103	13
2-111	0.424 x .103	13
2-112	0.487 x .103	13
2-113	0.549 x .103	13
2-114	0.612 x .103	13
2-115	0.674 x .103	13
2-116	0.737 x .103	13
2-210	0.734 x .139	10
2-211	0.796 x .139	10
2-212	0.859 x .139	10
2-213	0.921 x .139	10
2-214	0.984 x .139	10
2-215	1.046 x .139	10
2-216	1.109 x .139	10
2-217	1.171 x .139	10
2-218	1.234 x .139	10
2-219	1.296 x .139	10
2-220	1.359 x .139	10
2-221	1.421 x .139	10
2-222	1.484 x .139	10
2-225	1.475 x .210	7
2-226	1.600 x .210	7
2-227	1.725 x .210	7

Table 3-5: AS568 Kit #1 Sizes

Parker Metric Kit #1 Sizes

Dimensions	Quantity	Dimensions	Quantity
3.00 x 2.00	20	22.00 x 2.50	14
5.00 x 2.00	20	22.00 x 3.50	10
6.00 x 2.00	18	23.00 x 3.50	10
8.00 x 2.00	18	25.00 x 3.50	10
10.00 x 2.00	18	27.00 x 3.50	10
10.00 x 2.50	14	28.00 x 3.50	10
12.00 x 2.50	14	30.00 x 3.50	10
13.00 x 2.00	18	31.00 x 3.50	10
14.00 x 2.50	14	32.00 x 3.50	10
15.00 x 2.50	14	34.00 x 3.50	10
16.00 x 2.50	14	36.00 x 3.50	10
18.00 x 2.50	14	38.00 x 3.50	10
18.00 x 3.50	10	41.00 x 3.50	10
20.00 x 2.50	14	44.00 x 3.50	10
20.00 x 3.50	10	46.00 x 3.50	10
21.00 x 2.50	14	50.00 x 3.50	10

Table 3-6: Parker Metric Kit #1 Sizes



WARNING: These products can expose you to chemicals including carbon black (airborne and extracts), antimony trioxide, titanium dioxide, silica (crystalline), di(2-ethylhexyl) phthalate, ethylene thiourea, acrylonitrile, 1,3-butadiene, epichlorohydrin, toluenediisocyanate, tetrafluoroethylene, ethylbenzene, formaldehyde, furfuryl alcohol, glass fibers, methyl isobutyl ketone, nickel (metallic and compounds), lead and lead compounds which are known to the State of California to cause cancer; and 1,3-butadiene, epichlorohydrin, di(2-ethylhexyl)phthalate, di-isodecyl phthalate, ethylene thiourea, methyl isobutyl ketone, methanol, toluene, lead and lead compounds which are known to the State of California to cause birth defects and other reproductive harm. For more information go to www.P65Warnings.ca.gov.

Parker Boss Kit Sizes			
Size	Dimensions	Tube OD	Quantity
3-901	0.185 x .056	3/32	10
3-902	0.239 x .064	1/8	10
3-903	0.301 x .064	3/16	10
3-904	0.351 x .072	1/4	10
3-905	0.414 x .072	5/16	12
3-906	0.468 x .078	3/8	12
3-907	0.530 x .082	7/16	12
3-908	0.644 x .087	1/2	12
3-909	0.706 x .097	9/16	12
3-910	0.755 x .097	5/8	12
3-911	0.863 x .116	11/16	10
3-912	0.924 x .116	3/4	10
3-913	0.986 x .116	13/16	10
3-914	1.047 x .116	7/8	10
3-916	1.171 x .116	1	10
3-918	1.355 x .116	1 1/8	10
3-920	1.475 x .118	1 1/4	10
3-924	1.720 x .118	1 1/2	10
3-928	2.090 x .118	1 3/4	10
3-932	2.337 x .118	2	10

Table 3-7: Parker Boss Kit Sizes

3.2 Cleanliness

Cleanliness is vitally important to assure proper sealing action and long O-ring life. Every precaution must be taken to insure that all component parts are clean at time of assembly. Foreign particles — dust, dirt, metal chips, grit, etc.— in the gland may cause leakage and can damage the O-ring, reducing its life.

It is equally important to maintain clean hydraulic fluids *during* the normal operation of dynamic seal systems. Costly shut downs necessitated by excessive seal wear and requiring early seal replacement may be prevented by the use of effective filters in the fluid power system as well as installing wiper rings on actuating rods exposed to external dust, dirt and other contaminants.

3.3 Assembly

Assembly must be done with great care so that the O-ring is properly placed in the groove and is not damaged as the gland assembly is closed. Some of the more important design features to insure this are:

1. The I.D. stretch, as installed in the groove, should not be more than 5%. Excessive stretch will shorten the life of most O-ring materials. Also, see Figure 3-3 for data on the flattening effect produced by installation stretch.
2. The I.D. expansion needed to reach the groove during assembly ordinarily does not exceed 25-50% and should not exceed 50% of the ultimate elongation of the chosen compound. However, for small diameter O-rings, it may be necessary to exceed this rule of thumb. If so, sufficient time should be allowed for the O-ring to return to its normal diameter before closing the gland assembly.
3. The O-ring should not be twisted. Twisting during installation will most readily occur with O-rings having a large ratio of I.D. to cross-section diameter.

4. O-rings should never be forced over unprotected sharp corners, threads, keyways, slots, splines, ports, or other sharp edges. If impossible to avoid by proper design, then thimbles, supports, or other shielding arrangements must be used during assembly to prevent damage to the seal. See Figure 3-4.
5. Closure of the gland assembly must not pinch the O-ring at the groove corners.
6. Gland closure should be accomplished by straight longitudinal movement. Rotary or oscillatory motion is undesirable since it may cause bunching, misalignment and pinching or cutting of the seal.

3.4 Selecting the Best Cross-Section

In designing an O-ring seal, there are usually several standard cross-section diameters available. There are a number of factors to consider in deciding which one to use, and some of these factors are somewhat contradictory.

In a dynamic, reciprocating application, the choice is automatically narrowed because the design charts and tables do not include all the standard O-ring sizes. For any given piston or rod diameter, O-rings with smaller cross-section diameters are inherently less stable than larger cross-sections, tending to twist in the groove when reciprocating motion occurs. This leads to early O-ring spiral failure and leakage. The smaller cross-sections for each O-ring I.D. dimension are therefore omitted in the reciprocating seal design tables.

Nevertheless, for many dynamic applications, there is still some choice as to cross-section, and the larger cross-sections will prove to be the more stable. Counterweighing this factor, is the reduced breakaway and running friction obtainable with a smaller cross-section O-ring. These and other factors to be considered are tabulated on Table 3-8.

Effects of Cross Section	
Larger Section	Smaller Section
Dynamic Reciprocating Seals	
More stable	Less stable
More friction	Less friction
All Seals	
Requires larger supporting structure	Requires less space — reduces weight
Better compression set ⁽¹⁾	Poorer compression set ⁽¹⁾
Less volume swell in fluid	More volume swell in fluid
Less resistant to explosive decompression	More resistant to explosive decompression
Allows use of larger tolerances while still controlling squeeze adequately	Requires closer tolerances to control squeeze. More likely to leak due to dirt, lint, scratches, etc.
Less sensitive to dirt, lint, scratches, etc.	Better physical properties ⁽²⁾
Poorer physical properties ⁽²⁾	
Cost and availability are other factors to consider, and these would need to be determined for the particular sizes being considered.	

(1) Particularly true for nitrile and fluorocarbon elastomers. Doubtful for ethylene propylenes and silicones.
(2) Applies to tensile and elongation of nitriles, elongation of fluorocarbons.

Table 3-8: Effects of Cross Section

WARNING: These products can expose you to chemicals including carbon black (airborne and extracts), antimony trioxide, titanium dioxide, silica (crystalline), di(2-ethylhexyl) phthalate, ethylene thiourea, acrylonitrile, 1,3-butadiene, epichlorohydrin, toluenediisocyanate, tetrafluoroethylene, ethylbenzene, formaldehyde, furfuryl alcohol, glass fibers, methyl isobutyl ketone, nickel (metallic and compounds), lead and lead compounds which are known to the State of California to cause cancer; and 1,3-butadiene, epichlorohydrin, di(2-ethylhexyl)phthalate, di-isodecyl phthalate, ethylene thiourea, methyl isobutyl ketone, methanol, toluene, lead and lead compounds which are known to the State of California to cause birth defects and other reproductive harm. For more information go to www.P65Warnings.ca.gov.

3.5 Stretch

When an O-ring is stretched, its cross-section is reduced and flattened. When the centerline diameter is stretched more than two or three percent, the gland depth must be reduced to retain the necessary squeeze on the reduced and flattened cross-section. The “observed” curve shown in Figure 3-3 indicates how much the compression diameter is reduced. The necessary percentage of squeeze should be applied to this corrected compression diameter, reducing the gland depth below the recommended dimensions shown in the standard design charts.

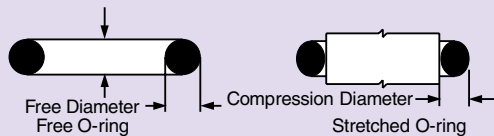

Loss of Compression Diameter (W) Due to Stretch

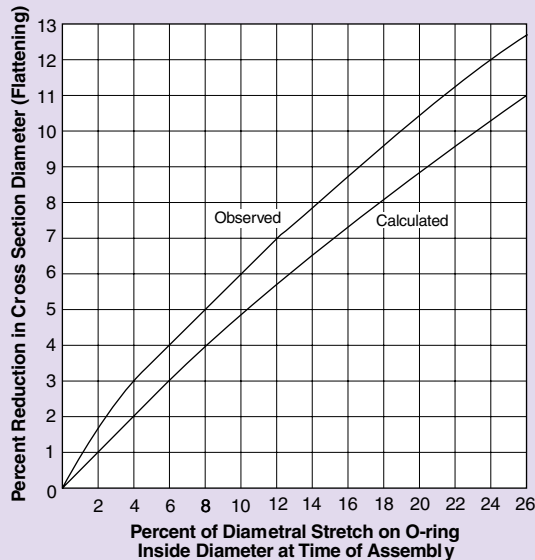

The “observed” curve is reproduced by courtesy of the Research Laboratories of General Motors Corporation at the General Motors Technical Center in Warren, Michigan. This curve is based on a statistical analysis of a much larger volume of experimental data than has been available previously.

In the stretched condition, an O-ring cross section is no longer circular. It is often necessary to compensate for the loss in squeeze resulting from the reduced “compression diameter.” Dimensional changes in the “free diameter” do not affect the seal.

Empirical formulas for observed curve:

0 to 3% Inside Dia. Stretch:
 $Y = -0.005 + 1.19X - 0.19X^2 - 0.001X^3 + 0.008X^4$

3 to 25% Inside Dia. Stretch:
 $Y = .56 + .59X - .0046X^2$

Where X = percent stretch on inside diameter
 (i.e. for 5% stretch, X = 5)
 Y = percent reduction in cross section diameter.

The calculated curve is based on the assumption that the O-ring section remains round and the volume does not change after stretching.

$$\text{Formula: } Y = 100 \left(1 - \sqrt{\frac{10}{100 + X}} \right)$$

Figure 3-3: Loss of Compression Diameter (W) Due to Stretch

Note: Figure 3-3 is valid for approximation purposes and even the majority of O-ring applications. However, more recent research has been done for the low stretch cases (i.e., 0–5%) where the observed values conform to a more complex hyperbolic function. For more information, refer to inPHorm seal design and material selection software.

Extra stretch may be necessary when a non-standard bore or rod diameter is encountered. In male gland (piston type) assemblies of large diameter, the recommended stretch is so slight that the O-ring may simply sag out of the groove. There is then the danger of pinching if the O-ring enters the bore “blind,” i.e. in a location where the seal cannot be watched and manually guided into the bore. For large diameter assemblies of this kind, it is well to use an O-ring one size smaller than indicated, but then the gland depth must be reduced as indicated above because the stretch may approach five percent.

Proper Designs for Installation of O-rings

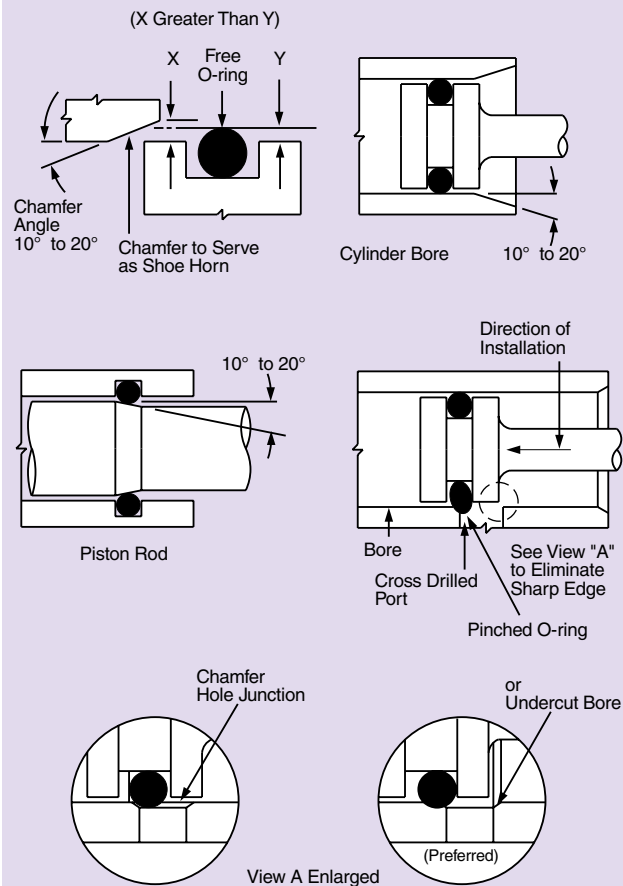

Figure 3-4: Proper Designs for Installation of O-rings

WARNING: These products can expose you to chemicals including carbon black (airborne and extracts), antimony trioxide, titanium dioxide, silica (crystalline), di(2-ethylhexyl) phthalate, ethylene thiourea, acrylonitrile, 1,3-butadiene, epichlorohydrin, toluenediisocyanate, tetrafluoroethylene, ethylbenzene, formaldehyde, furfuryl alcohol, glass fibers, methyl isobutyl ketone, nickel (metallic and compounds), lead and lead compounds which are known to the State of California to cause cancer; and 1,3-butadiene, epichlorohydrin, di(2-ethylhexyl)phthalate, di-isodecyl phthalate, ethylene thiourea, methyl isobutyl ketone, methanol, toluene, lead and lead compounds which are known to the State of California to cause birth defects and other reproductive harm. For more information go to www.P65Warnings.ca.gov.

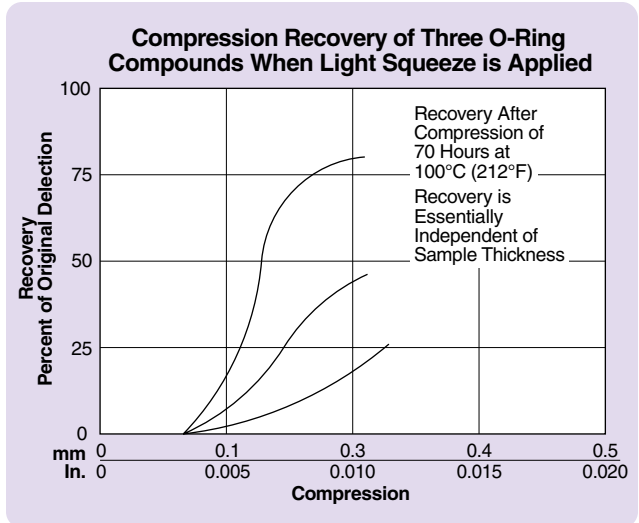

Figure 3-5: Compression Recovery of Three O-ring Compounds When Light Squeeze is Applied

An assembled stretch greater than five percent is not recommended because the internal stress on the O-ring causes more rapid aging. Over five percent stretch may sometimes be used, however, if a shorter useful life is acceptable.

Of the commonly used O-ring seal elastomers, the reduction in useful life is probably greatest with nitrile materials. Therefore, where high stretch is necessary, it is best to use ethylene propylene, fluorocarbon, polyurethane or neoprene, whichever material has the necessary resistance to the temperatures and fluids involved.

3.6 Squeeze

The tendency of an O-ring to attempt to return to its original uncompressed shape when the cross-section is deflected is the basic reason why O-rings make such excellent seals. Obviously then, squeeze is a major consideration in O-ring seal design.

In dynamic applications, the *maximum* recommended squeeze is approximately 16%, due to friction and wear considerations, though smaller cross-sections may be squeezed as much as 25%.

When used as a static seal, the maximum recommended squeeze for most elastomers is 30%, though this amount may cause assembly problems in a radial squeeze seal design. In a face seal situation, however, a 30% squeeze is often beneficial because recovery is more complete in this range, and the seal may function at a somewhat lower temperature. There is a danger in squeezing much more than 30% since the extra stress induced may contribute to early seal deterioration. Somewhat higher squeeze may be used if the seal will not be exposed to high temperatures nor to fluids that tend to attack the elastomer and cause additional swell.

The minimum squeeze for all seals, regardless of cross-section should be about .2 mm (.007 inches). The reason is that with a very light squeeze almost all elastomers quickly

take 100% compression set. Figure 3-5 illustrates this lack of recovery when the squeeze is less than .1 mm (.005 inch). The three curves, representing three nitrile compounds, show very clearly that a good compression set resistant compound can be distinguished from a poor one only when the applied squeeze exceeds .1 mm (.005 inches).

Most seal applications cannot tolerate a “no” or zero squeeze condition. Exceptions include low-pressure air valves, for which the floating pneumatic piston ring design is commonly used, and some rotary O-ring seal applications. See the Dynamic O-Ring Sealing, Section V, and Tables A6-6 and A6-7 for more information on pneumatic and rotary O-ring seal design.

3.7 Gland Fill

The percentage of gland volume that an O-ring cross-section displaces in its confining gland is called “gland fill”. Most O-ring seal applications call for a gland fill of between 60% to 85% of the available volume with the optimum fill being 75% (or 25% void). The reason for the 60% to 85% range is because of potential tolerance stacking, O-ring volume swell and possible thermal expansion of the seal. It is essential to allow at least a 10% void in any elastomer sealing gland.

3.8 O-Ring Compression Force

The force required to compress each linear inch of an O-ring seal depends principally on the shore hardness of the O-ring, its cross-section, and the amount of compression desired. Even if all these factors are the same, the compressive force per linear inch for two rings will still vary if the rings are made from different compounds or if their inside diameters are different. The anticipated load for a given installation is not fixed, but is a range of values. The values obtained from a large number of tests are expressed in the bar charts of Figures 2-4 through 2-8 in Section II. If the hardness of the compound is known quite accurately, the table for O-ring compression force, Table 2-3 may be used to determine which portion of the bar is most likely to apply.

Increased service temperatures generally tend to soften elastomeric materials (at least at first). Yet the compression force decreases very little except for the hardest compounds. For instance, the compression force for O-rings in compound N0674-70 decreased only 10% as the temperature was increased from 24°C (75°F) to 126°C (258°F). In compound N0552-90 the compression force decrease was 22% through the same temperature range.

Refer to Figure 3-6 for the following information:

The dotted line indicates the approximate linear change in the cross section (W) of an O-ring when the gland prevents any change in the I.D. with shrinkage, or the O.D., with swell. Hence this curve indicates the change in the effective squeeze on an O-ring due to shrinkage or swell. Note that volumetric change may not be such a disadvantage as it appears at first glance. A volumetric shrinkage of six percent results in only three percent

WARNING: These products can expose you to chemicals including carbon black (airborne and extracts), antimony trioxide, titanium dioxide, silica (crystalline), di(2-ethylhexyl) phthalate, ethylene thiourea, acrylonitrile, 1,3-butadiene, epichlorohydrin, toluenediisocyanate, tetrafluoroethylene, ethylbenzene, formaldehyde, furfuryl alcohol, glass fibers, methyl isobutyl ketone, nickel (metallic and compounds), lead and lead compounds which are known to the State of California to cause cancer; and 1,3-butadiene, epichlorohydrin, di(2-ethylhexyl)phthalate, di-isodecyl phthalate, ethylene thiourea, methyl isobutyl ketone, methanol, toluene, lead and lead compounds which are known to the State of California to cause birth defects and other reproductive harm. For more information go to www.P65Warnings.ca.gov.

linear shrinkage when the O-ring is confined in a gland. This represents a reduction of only .003" of squeeze on an O-ring having a .103" cross-section (W) dimension. The solid lines indicate linear change in both I.D. and cross-section for a free-state (unconfined) O-ring.

O-Ring Linear vs. Volume Change Relationship

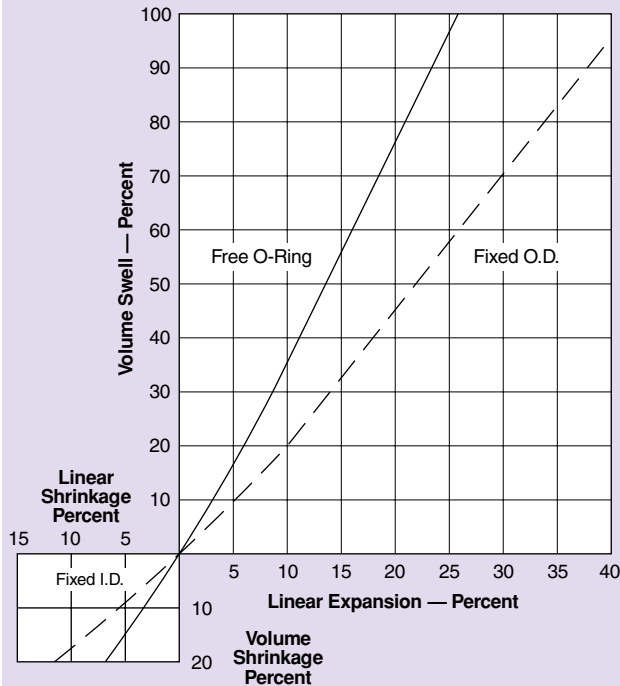

Figure 3-6: O-ring Linear vs. Volume Change Relationship

3.9 Specific Applications

3.9.1 Automotive

The types of elastomer compound required by this industry are numerous and the variety of applications quite extensive. The following examples can be viewed as a brief analysis of the problems found in the automotive industry.

The demands made on an elastomer at high and low temperatures are even greater than normal while compatibility with new chemical additives which improve the physical properties of automotive fuels and oils, require continuous improvement in elastomeric compounds for automotive service.

The selection of the proper O-ring compound depends on the temperature at the sealing interface and of the contact medium. Each group of elastomers have a working range of temperatures.

The low temperature requirements for many automotive applications are often below the brittleness point for elastomers like FKM, ACM and NBR. However, static applications, leakage at low temperatures may not occur because of O-ring deformation and the high viscosity of the sealed medium. The critical temperature often is bridged when the seal warms quickly in service.

3.9.2 Engine

See Table 3-9.

General requirements:

Temperature: -40°C to 125°C (-40°F to 250°F)
 (sometimes higher)

Medium: Engine oil, cooling water, fuel, hot air and mixtures of these media

Engine Applications

Application	Medium	Temperature Range °C (°F)	Compounds	
			ASTM D1418	Parker
Motor oil Oil filter	SAE-Oils	-35°C to 110°C (-31°F to 230°F)	NBR	N0674-70
		-30°C to 120°C (-22°F to 248°F)	NBR	N0951-75
		-25°C to 200°C (-13°F to 392°F)	FKM	V1164-75
		-25°C to 150°C (-13°F to 392 °F)	ACM	AA150-70
Wet cylinders (Diesel)	Water/ Oil	-30°C to 100°C (-22°F to 212°F)	NBR	N0951-75
		-25°C to 120°C (-13°F to 248°F)	FKM	V1164-70
Air-filter	Air/Fuel	-35°C to 90°C (-31°F to 194°F)	NBR	N0674-70
		-60°C to 210°C (-76°F to 410°F)	VMQ	S1224-70

Table 3-9: Engine Applications

3.9.3 Brake System

General requirements:

Temperature: -40°C to 150°C (-40°F to 302°F)

Medium: Synthetic brake fluid (Dot3, Dot4, Dot5) with glycol or glycol-ether base to Department of Transportation and SAE recommendations

Compound: E0667-70, E1022-70

3.9.4 Fuel System

Gasoline and diesel fuels are used in normal commercial vehicles. Fuels are more aggressive than mineral oils and cause higher swelling of the elastomer which increases with temperature. Swelling of an elastomer in fuel is, however, generally reversible when the absorbed fuel vaporizes completely. When parts of a compound are dissolved or leached out of the elastomer however, shrinkage takes place which is permanent. If a nitrile-based compound is required, a compound must be selected which contains minimum amounts of plasticisers, anti-aging or anti-ozone additives. By careful selection of the seal compound, the tendency to shrinkage or cold brittleness is avoided.



WARNING: These products can expose you to chemicals including carbon black (airborne and extracts), antimony trioxide, titanium dioxide, silica (crystalline), di(2-ethylhexyl) phthalate, ethylene thiourea, acrylonitrile, 1,3-butadiene, epichlorohydrin, toluenediisocyanate, tetrafluoroethylene, ethylbenzene, formaldehyde, furfuryl alcohol, glass fibers, methyl isobutyl ketone, nickel (metallic and compounds), lead and lead compounds which are known to the State of California to cause cancer; and 1,3-butadiene, epichlorohydrin, di(2-ethylhexyl)phthalate, di-isodecyl phthalate, ethylene thiourea, methyl isobutyl ketone, methanol, toluene, lead and lead compounds which are known to the State of California to cause birth defects and other reproductive harm. For more information go to www.P65Warnings.ca.gov.

3.9.5 Fuels for Automobile Engines

There are several automotive fuels on the market; gasoline (which can contain 10-20% ethanol), ethanol/E85, diesel and biodiesel are the most common. Parker is at the forefront in testing elastomer materials for use in traditional and alternative fuels. For the latest information and test data regarding this rapidly changing industry, please contact Parker's O-Ring Division.

The best rubber compound to use depends not only on the fuel itself, but also on the temperature range anticipated and the type of usage; i.e. whether in a static or a dynamic application. In automotive fuel applications, extremely high temperatures are not anticipated, but in northern climates, temperatures as low as -40°C (-40°F) or even -54°C (-65°F) are sometimes encountered.

Most of the compounds recommended for use in fuel have rather poor low temperature capability in air, but in a fluid that swells them the low temperature capability improves. In studying the effects of volume swell on low temperature, it was found that for each percent of volume swell in a fuel, the low temperature capability (TR-10) was improved between 0.5°C and 1°C (1°F and 2°F).

The TR-10 value is a good indicator of the low temperature limit of a dynamic seal or a static seal exposed to pulsating pressure. In a static steady pressure application, an O-ring will generally function to a temperature approximately 8°C (15°F) lower than the TR-10 temperature.

The volume swell chart that follows, therefore, can be used to approximate the low temperature capability of a given compound in a given automotive fuel. The results will not be precise because the effect of volume swell on the TR-10 value is not precise, and also because the composition of the fuels themselves is not uniform.

In static applications, even in most extreme volume cases, swell can sometimes be tolerated. An O-ring can swell only until it completely fills the cavity. Further increase in volume is not possible, regardless of how much volume swell

is observed in a full immersion test. If the free state swell exceeds 50 percent, however, a radial squeeze assembly may be almost impossible to take apart because of the osmotic forces generated.

In dynamic applications, volume swell up to 15 or 20 percent is usually acceptable, but higher values are likely to increase friction and reduce toughness and abrasion resistance to the point that use of the particular compound is no longer feasible.

With these factors in mind, the data in Table 3-10 can be helpful in finding a suitable compound to use in a given automotive fuel application.

3.9.6 Transmission

General requirements:

- Temperature: 90°C (158°F)
(short periods up to 150°C) (302°F)
- Medium: Gear oil (reference oil SAE 90)

For automatic transmission:

- Medium: ATF oil (Automatic Transmission Fluid)
- Compound: N0674-70, N0552-90, AA150-70, AE152-70 (Vamac), V1164-75, V0884-75 (brown)

3.9.7 Cooling and Heating Systems

General requirements:

- Temperature: -40°C to 100°C (-40°F to 212°F)
(short periods up to 120°C (257°F))
- Medium: a) Water-glycol mixture 1:1 (with 1 to 2% corrosion retarding additives)
- Medium: b) Water-ethylene glycol mixture 1:1 (Prestone® antifreeze)
- Compound: E0803-70

Volume Swell of Compounds					
Compound No.	47-071 ⁽²⁾	N0497-70	N0674-70 ⁽²⁾	V0747-75 ⁽²⁾	V0834-70
TR-10 in air	-40°F	-23°F	-15°F	+5°F	+5°F
FUEL					
Unleaded gasoline	12%	14%	36%	1%	1%
Unleaded +10% ethanol ⁽³⁾	26%	24%	53%	5%	2%
Unleaded +20% ethanol	24%	24%	56%	4%	5%
Unleaded +10% methanol	35%	33%	66%	14%	16%
Unleaded +20% methanol	32%	30%	67%	26%	36%

(1) Volume swell of 2-214 O-ring immersed in the fuel for 70 hours at room temperature.

(2) Stock standard compounds. Generally available off-the-shelf.

(3) The "gasohol" mixture most commonly used in the United States consists of unleaded gasoline plus 10% ethanol (ethyl alcohol).

Table 3-10: Volume Swell of Compounds

Prestone® is a registered trademark of Prestone Products Corporation.

WARNING: These products can expose you to chemicals including carbon black (airborne and extracts), antimony trioxide, titanium dioxide, silica (crystalline), di(2-ethylhexyl) phthalate, ethylene thiourea, acrylonitrile, 1,3-butadiene, epichlorohydrin, toluenediisocyanate, tetrafluoroethylene, ethylbenzene, formaldehyde, furfuryl alcohol, glass fibers, methyl isobutyl ketone, nickel (metallic and compounds), lead and lead compounds which are known to the State of California to cause cancer; and 1,3-butadiene, epichlorohydrin, di(2-ethylhexyl)phthalate, di-isodecyl phthalate, ethylene thiourea, methyl isobutyl ketone, methanol, toluene, lead and lead compounds which are known to the State of California to cause birth defects and other reproductive harm. For more information go to www.P65Warnings.ca.gov.

3.9.8 Air Conditioning

Automotive A/C units are almost exclusively charged with refrigerant R134a, whereas existing units are generally filled with the older (and now banned in US) R12 Freon refrigerant.

Special oils are added to the refrigerant in order to lubricate the compressor: R134a systems use mostly polyalkylene glycol oils, whereas R12 systems employ mostly mineral oils.

General requirements:

Temperature: -40°C to 80°C (-40°F to 175°F)

Medium: refrigerant R134a
refrigerant R12
polyalkylene glycol oil
mineral oil

Compound: C0873-70, N1173-70

3.9.9 Power Steering Systems

General requirements:

Temperature: Up to 120°C (-40°F to 257°F)
(short periods up to 150°C (302°F))

Medium: Power steering fluid

Compound: N0674-70, N0552-90, AA150-70,
AE152-70 (Vamac), V1164-75,
V0884-75 (brown)

Compound Recommendation for Refrigerants

Fluorinated Hydrocarbons Refrigerant (R)	ASTM D1418	Parker
11	NBR	N0674-70
12	CR	C0873-70
12 and ASTM oil no. 2 (mixed 50:50)	FKM	V1164-75
12 and Suniso 4G (mixed 50:50)	FKM	V1164-75
13	CR	C0873-70
13 B1	CR	C0873-70
14	CR	C0873-70
21	CR	C0873-70
22	CR	C0873-70
22 and ASTM oil no. 2 (mixed 50:50)	CR	C0873-70
31	CR	C0873-70
32	CR	C0873-70
112	FKM	V1164-75
113	CR	C0873-70
114	CR	C0873-70
114 B2	CR	C0873-70
115	CR	C0873-70
502	CR	C0873-70
134a	CR	C0873-70
BF (R112)	FKM	V1164-75
C318	CR	C0873-70
K-152a	CR	C0873-70
K-142b	CR	C0873-70
MF (R11)	NBR	N0674-70
PCA (R113)	CR	C0873-70
TF (R113)	CR	C0873-70

Table 3-11: Compound Recommendation for Refrigerants

Frigen® is a registered trademark of Canadian Hoechst Limited Corporation.

Kaltron® is a registered trademark of Joh A. Benckiser GMBH Joint Stock Company.

Oils are preferred which tend to have a constant viscosity over a wide temperature range. These highly developed oils can be very aggressive.

FKM or ACM based materials are often preferred when high operating temperatures are involved.

3.9.10 Refrigeration and Air Conditioning

Seals used in cooling systems should be fully compatible with the refrigerant. Refrigerants often are coded “R” and consist of fluids based on fluorinated and chlorinated hydrocarbons.

Trade names, e.g. Freon, Frigen®, Kaltron® are used together with the type number.

Examples:

- R13 corresponds to Freon 13 and Kaltron 13
- R13 B1 corresponds to Freon 13 B1, Frigen 13 B1 and Kaltron 13 B1

Fire extinguishers are propelled with Halon R1301 corresponding to Freon 13 B1.

Several of these refrigerants also are used as propellants in aerosol containers. Further information on compounds can be found in the Fluid Compatibility Tables in Section VII. See Table 3-11.

3.9.11 Food, Beverage and Potable Water

The Food and Drug Administration (FDA) has established a list of rubber compounding ingredients which tests have indicated are neither toxic nor carcinogenic (cancer producing). Rubber compounds produced entirely from these ingredients and which also pass the FDA extraction tests are said to “meet the FDA requirements” per 21 CFR177.2600. The FDA does not approve rubber compounds. It is the responsibility of the manufacturer to compound food grade materials from the FDA list of ingredients and establish whether they pass the necessary extraction requirements.

3-A Sanitary Standards have been formulated by the United States Public Health Service, the International Association of Milk Food and Environmental Standards, and the Dairy and Food Industries Supply Association. A similar document, E-3A Sanitary Standards, was later formulated by this same group plus the United States Department of Agriculture and the Institute of American Poultry Industries. The 3-A standards are intended for elastomers to be used as product contact surfaces in dairy equipment, while the E-3A standards are intended for elastomers used as product contact surfaces in egg processing equipment. The requirements of the two specifications are essentially identical, the intent in each case being to determine whether rubber materials are capable of being cleaned and receiving an effective bactericidal treatment while still maintaining their physical properties after repeated applications of the cleaning process chemicals.

WARNING: These products can expose you to chemicals including carbon black (airborne and extracts), antimony trioxide, titanium dioxide, silica (crystalline), di(2-ethylhexyl) phthalate, ethylene thiourea, acrylonitrile, 1,3-butadiene, epichlorohydrin, toluenediisocyanate, tetrafluoroethylene, ethylbenzene, formaldehyde, furfuryl alcohol, glass fibers, methyl isobutyl ketone, nickel (metallic and compounds), lead and lead compounds which are known to the State of California to cause cancer; and 1,3-butadiene, epichlorohydrin, di(2-ethylhexyl)phthalate, di-isodecyl phthalate, ethylene thiourea, methyl isobutyl ketone, methanol, toluene, lead and lead compounds which are known to the State of California to cause birth defects and other reproductive harm. For more information go to www.P65Warnings.ca.gov.

Parker Seal produces a number of compounds that meet FDA requirements, and the most popular of these have been tested to the 3-A and E-3A standards. Information on some of these and other Parker food grade compounds is contained in Table 3-12 to assist the user in selecting the most suitable compound for their particular food application.

Parker Compounds that Meet FDA Requirements			
Polymer	FDA Compound Number	3A and E3A Classes	Color/Other Features
Ethylene Propylene	E1028-70	NT ⁽¹⁾	Black
Fluorocarbon	V0680-70	1,2,3,4	Red/USDA
Nitrile	N1069-70	NT ⁽¹⁾	Black
	N1219-60	NT ⁽¹⁾	Black
	N1220-70	NT ⁽¹⁾	Black
	N0508-75	1,2,3,4	Black, USDA ⁽²⁾
Silicone	S0802-40	2,3,4	White
	S0317-60	1,2,3,4	Rust/ZZ-R-765, Classes 1A, 1B, 2A, 2B/USDA
	S1138-70	NT ⁽¹⁾	Rust
	S0355-75	1,2,3,4	Rust/USDA ⁽²⁾

(1) NT = Not tested

(2) USDA = Declared "chemically acceptable" by United States Department of Agriculture, Animal and Plant Health Inspection Service, Meat and Poultry Inspection Program. "They may be used in processing or storage areas for contact with meat or poultry food product prepared under Federal inspection..."

Table 3-12: Parker Compounds That Meet FDA Requirements

National Sanitation Foundation

Additional requirements have been imposed upon seal manufacturers regarding food, beverage and potable water service. NSF 51, Food and Beverage, and NSF 61, Potable Water, deal with indirect additives that may arise by migration into food, beverage and potable water from rubber, plastic, metal or other materials. Parker Seal has developed a number of compounds, which meet NSF 51 and NSF 61 requirements. Some of these are listed below.

NSF 51 Certified Materials	NSF 61 Certified Materials
N1219-60	N0757-70
N1220-70	E3609-70
V0680-70	E1244-70
E3609-70	E1512-70
	E1549-70
	E1561-60
	E1571-70
	E1570-70
	E1583-70
	EJ273-70
	EJ274-70

3.9.12 Aerospace Technology

The aerospace industry demands the most from elastomeric compounds. Special materials often must be developed to meet specification requirements. Additionally many special requirements must be met during the production of finished parts, not least to meet safety, technical and quality requirements.

Our experience in aerospace sealing has been gained by working with a variety of global airframe and jet engine customers and as well as being represented on a number of standardization committees.

3.9.12.1 Jet Fuels

In static applications, jet fuels can generally be sealed with nitrile O-ring materials such as Parker's N0602-70. In the older jet fuels, such as JP-3, JP-4, and JP-5, and the later JP-8 and RJ-4, the swell seldom exceeds 20%. In JP-9 and JP-10, the normal volume swell is 24 to 40%. In a standard O-ring cavity, the rubber is confined, and cannot swell to this extent. The standard cavities have at least 10% excess void, allowing the O-rings to swell this amount before they are contained. This extra space greatly reduces the pressures that can be generated by a confined elastomer and avoids damaging any but the very lightest type of structure.

In dynamic applications, Parker's V1164-75 fluorocarbon elastomer may be used because it swells less than 2% in these fluids, but its low temperature capability does not normally extend below -29°C (-20°F).

3.9.12.2 Liquid Rocket Propellants

(Nitrogen Tetroxide/Aerozine 50) Rocket propulsion systems utilizing oxidizer and fuel combinations such as nitrogen tetroxide (N₂O₄) and Aerozine 50 (50/50 mixture of UDMH and hydrazine) prompted development of an elastomeric compound to seal against these fluids. The fuel system (i.e. Aerozine 50) does not pose as difficult a sealing problem as does the oxidizer. Most currently available elastomeric compounds are degraded by the extremely vigorous N₂O₄ oxidizer. However, Parker developed a number of compounds which demonstrate markedly improved resistance to N₂O₄ in both liquid and vapor phases.

The expected life of a seal of conventional design immersed in N₂O₄ is limited. Considerable useful seal life with the material however, has been realized through special design practices. In the Gask-O-Seal rubber/metal configuration, where only a minute portion of the sealing element is exposed to the fluid, Parker compounds have sealed nitrogen tetroxide at room temperature for more than a year.



WARNING: These products can expose you to chemicals including carbon black (airborne and extracts), antimony trioxide, titanium dioxide, silica (crystalline), di(2-ethylhexyl) phthalate, ethylene thiourea, acrylonitrile, 1,3-butadiene, epichlorohydrin, toluenediisocyanate, tetrafluoroethylene, ethylbenzene, formaldehyde, furfuryl alcohol, glass fibers, methyl isobutyl ketone, nickel (metallic and compounds), lead and lead compounds which are known to the State of California to cause cancer; and 1,3-butadiene, epichlorohydrin, di(2-ethylhexyl)phthalate, di-isodecyl phthalate, ethylene thiourea, methyl isobutyl ketone, methanol, toluene, lead and lead compounds which are known to the State of California to cause birth defects and other reproductive harm. For more information go to www.P65Warnings.ca.gov.

3.9.13 Nuclear Technology

Elastomers which are compounded for exposure to radiation must satisfy stringent quality and material qualification tests. In addition to resisting radiation, the elastomer also must be compatible with the contact medium under the working environment (temperature, pressure, etc).

In the majority of these applications, the radiation dosage level remains below 10^6 rad, a level normally attained after years of operation. Practically all elastomers suffer no change of their physical properties at radiation levels up to 1 M rad (= 10^6 rad = 10^4 J/kg). Parker has developed compounds with resistance to radiation levels of 10^7 rad.

Water and steam are common media in nuclear applications. Typical nuclear operating conditions are:

- Temperature: 180°C (350°F)
- Irradiation: 10^7 rad

3.9.14 Radiation

One of the most important properties if an elastomer used as an O-ring seal is its resistance to compression set. On exposure to gamma radiation, it is compression set that is most severely affected. After experiencing 1×10^8 rads, all elastomers tested had taken over 85% set, enough loss of “memory” that leakage would be expected. At 1×10^7 rads, there were big differences between compounds, while at 1×10^6 rads, the effects on all compounds were minor. It is therefore in the range of 1×10^7 , that an O-ring compound must be selected with care, while at higher levels they should not be considered, and at lower levels factors other than radiation will be more significant.

In a reactor, seals are often exposed to hot water, steam, hot air, silicone fluids or other influences in addition to the radiation. The total effect is probably greater than a simple addition of the individual effects, and it is therefore important to test a seal in conditions similar to those it will encounter in service. Because effects vary with the individual compound, it is important that the exact compound be specified, and not merely the type of polymer.

Table 3-13 gives data to aid in selecting the most promising compounds to test for many combinations of conditions.

3.9.15 Energy, Oil and Gas

Applications in the offshore industry pose new and unique problems for seal manufacturers. Working conditions are very difficult involving:

- Aggressive contact media
- High pressures
- Wide range of temperatures

Critical conditions occur in connection with:

- Oil additives causing chemical attack
- Explosive decompression
- Clearance gap extrusion at high pressure
- High and low temperatures

Contact media are gas, oil, water (sea water, ground water), drilling mud, sour gas, CO₂, steam, rinsing water, lubricants (additives in lubricants as rust inhibitors), etc.

Working conditions vary greatly to location and function.

Temperatures: up to 225°C (450°F) plus peaks

Working pressures: 100 to 1000 Bar and higher
 (1450 psi to 14500 psi and higher)

Contact our Application Engineering Department regarding the above and more difficult conditions.

3.9.16 Fungus-Resistant Compounds

Both the extreme environmental conditions experienced by the military and efforts in space have focused attention on many previously overlooked facets of hardware. Among these is the ability of materials to resist degradation caused by fungus. Fungus is a problem in tropical regions such as southeast Asia. A number of Parker compounds have been submitted to an independent laboratory for fungus resistance exposure tests. The results of this study document that the Parker compounds shown in Table 3-14 are non-nutrient to fungus as defined by MIL-STD-810F, Method 508.5.

Data on Radiation Resistant Compounds

Compound	Polymer	Comp. Set at 10 ⁷ Rads ⁽¹⁾	Max. Temp. ⁽²⁾	Steam & Water Resistance	Silicone Fluid Resistance
S0604-70	Silicone	20.0%	204°C (400°F)	Poor	Poor
N0674-70	Nitrile	24.3%	149°C (300°F)	OK to 49°C (120°F)	Good
N0741-75	Nitrile	24.3%	149°C (300°F)	OK to 49°C (120°F)	Good
E0740-75	Ethylene Propylene	28.6%	177°C (350°F)	Good	Good
S0455-70	Silicone (Hi Temp)	31.4%	177°C (350°F)	Poor	Poor
E0515-80	Ethylene Propylene	46.6%	149°C (300°F)	Good	Good
P0642-70	Polyurethane	55.2%	82°C (180°F)	Poor	Good
A0607-70 ⁽³⁾	Polyacrylate	61.5%	149°C (300°F)	Poor	Good
V0747-75	Fluorocarbon	66.7%	204°C (400°F)	Poor	Good
L0677-70 ⁽³⁾	Fluorosilicone	67.6%	204°C (400°F)	Poor	Good

(1) Compression set after exposure to 10^7 rads of gamma radiation at room temperature. The lower values are preferred. If over 40%, use only at lower dosage level.

(2) Temperature at which .139 cross section ring takes a 90% compression set after 1000 hours when not exposed to radiation or fluids.

(3) Material is obsolete, data presented represents family of materials.

Note: Some of these compounds may no longer be available.

Table 3-13: Data on Radiation Resistant Compounds

WARNING: These products can expose you to chemicals including carbon black (airborne and extracts), antimony trioxide, titanium dioxide, silica (crystalline), di(2-ethylhexyl) phthalate, ethylene thiourea, acrylonitrile, 1,3-butadiene, epichlorohydrin, toluenediisocyanate, tetrafluoroethylene, ethylbenzene, formaldehyde, furfuryl alcohol, glass fibers, methyl isobutyl ketone, nickel (metallic and compounds), lead and lead compounds which are known to the State of California to cause cancer; and 1,3-butadiene, epichlorohydrin, di(2-ethylhexyl)phthalate, di-isodecyl phthalate, ethylene thiourea, methyl isobutyl ketone, methanol, toluene, lead and lead compounds which are known to the State of California to cause birth defects and other reproductive harm. For more information go to www.P65Warnings.ca.gov.

With the possible exceptions of natural rubber and polyurethane, the base polymers for elastomers are normally non-nutrient to fungi. Nevertheless, there are compounds that will support fungus growth because they contain nutrient type ingredients. The plasticizer used is of particular importance in this respect. By studying all the ingredients of a particular compound, a chemist can predict quite accurately whether it will support fungus growth, without conducting a test. Therefore, if it is desirable to use some compound not listed below in an application that requires a non-nutrient material, contact Parker's Application Engineering Department to determine whether the compound is a good candidate for the application.

Fungus Tests on Compounds

Fungus testing per MIL-STD-810F, Method 508.5-I⁽¹⁾

Non-Nutrient to Fungus Growth (Rating ≤ 1)		Supports Fungus Growth (Rating > 1)	
Ethylene	Nitrile	Butyl	Neoprene
Propylene	(0) N0545-40	(2) B0612-70	(2) C0873-70
(1) E0692-75	(0) N0299-50		(2) C1124-70
(1) E0515-80	(0) N0525-60	Ethylene	(3) C0267-50
	(0) N0506-65	Propylene	
Fluorocarbon	(0) 47-071	(2) E0540-80	Nitrile
(1) V1164-75	(0) N0103-70	(2) E0740-75	(2) N0750-80
(1) V0709-90	(0) N0497-70	(3) E0652-90	(2) N0951-75
(0) VX065-75	(0) N0602-70	(0) N0603-70	(3) N1069-70
(0) VM125-75	(0) N0507-90	(3) E0803-70	(4) N0756-75
(0) V1289-75*	(0) N0552-90		
	(0) N0406-60	Fluorocarbon	
Fluorosilicone	(1) N0674-70	(2) V0680-70	
(1) L1120-70	(1) N0818-70	(2) V0747-75	
	(1) N0304-75		
Silicone	(1) N0300-90		
(0) S0595-50			
(0) S0317-60			
(0) S0455-70			
(0) S0604-70			
(0) S0614-80			
(0) S0613-60			
(0) S0355-75			

(1) Testing performed on U.S. fungal species only.
Note: Some of these compounds may no longer be available.
Please Refer to Table 508.5-II for rating standards.

Table 3-14: Fungus Tests on Compounds

Table 508.5-II Evaluation Scheme for Visible Effects*

Amount of Growth	Rating	Comments
None	0	Substrate devoid of microbial growth.
Trace	1	Scattered, sparse or very restricted microbial growth.
Light	2	Intermittent infestations or loosely spread microbial colonies.
Medium	3	Substantial amount of microbial growth.
Heavy	4	Massive microbial growth.

Note: Some of these compounds may no longer be available.
Please Refer to Table 508.5-II for rating standards.

3.9.17 Hydraulic Fluids

There are so many types of hydraulic fluids that only the highest performance O-ring compounds can be used to seal all of them. If a specific fluid is not listed in Section VII, a good candidate O-ring material can be selected from Table 3-15 if the type of the hydraulic fluid is known. Of course, it is important to select a seal compound having a temperature range that is suitable for the application.

3.9.17.1 Fire-Resistant Hydraulic Fluids

When mineral oils represent a high fire risk, fire-resistant hydraulic fluids are used. Three groups of such fluids are:

- Water emulsions (HFA and HFB groups)
- Water solutions (HFC)
- Water-free synthetic fluids (HFD)

The types of fire-resistant hydraulic fluids are presented in Table 3-16.

Fluids containing water rely on their water content to prevent fire. To remain effective, such fluids must be regularly checked and their water concentration maintained. Working temperatures are limited to between 50°C and 65°C (120°F to 150°F) because water easily evaporates at higher temperatures. All fluids containing water have one common feature: they have a negative effect upon bearings.

According to ISO Specification 6071, HFA, HFB and HFC hydraulic fluids are differentiated further by the suffix letters C, M, E and S:

- C indicates that no wear inhibitor is present
- M indicates that a wear inhibitor is present
- E indicates a mineral oil based HFA fluid
- S indicates a synthetic HFA fluid

Table 3-17 shows a comparison of the most important properties of the four groups of non-flammable fluids together with the recommended type of elastomer.

3.9.17.1.1 HFA Fluids

HFA fluids contain more than 80% water. In practice 95% to 98% water is more common, the balance being "concentrates" which improve wear and corrosion resistance.

The relationship between water content and concentrate offers the greatest threat to the proper function of HFA fluids. The local water supply is not only different from one area to the next, but its various constituents may cause the hardness to vary. The operating solution is mixed by the user and not by the manufacturer. HFA concentrates can have mineral oil or synthetic oil bases.

Types of Non-Flammable Hydraulic Fluids

Type of Hydraulic Fluid	Content	Application
Hydraulic fluid HFA	Oil in water emulsion	Hydraulic fluid e.g. for hydraulic presses
Hydraulic fluid HFB	Water in oil emulsion	Hydraulic fluid e.g. for hydraulic presses
Hydraulic fluid HFC	Water polymer solutions	Fire risk systems to max. 60°C at low pressure
Hydraulic fluid HFD	Waterless synthetic fluid	For fire risk systems at high temperatures and pressures

Table 3-17: Types of Non-Flammable Hydraulic Fluids

WARNING: These products can expose you to chemicals including carbon black (airborne and extracts), antimony trioxide, titanium dioxide, silica (crystalline), di(2-ethylhexyl) phthalate, ethylene thiourea, acrylonitrile, 1,3-butadiene, epichlorohydrin, toluenediisocyanate, tetrafluoroethylene, ethylbenzene, formaldehyde, furfuryl alcohol, glass fibers, methyl isobutyl ketone, nickel (metallic and compounds), lead and lead compounds which are known to the State of California to cause cancer; and 1,3-butadiene, epichlorohydrin, di(2-ethylhexyl)phthalate, di-isodecyl phthalate, ethylene thiourea, methyl isobutyl ketone, methanol, toluene, lead and lead compounds which are known to the State of California to cause birth defects and other reproductive harm. For more information go to www.P65Warnings.ca.gov.

Compounds for Hydraulic Fluids

	Temp. Range	O-Ring Compounds
High-Water-Base Fluids (95-5 Fluids)	4°C to 49°C (40°F to 120°F)	N0674-70, nitrile E0540-80, ethylene propylene
Hydrocarbon Base Hydraulic Fluids (including petroleum base)	-54°C to 149°C (-65°F to 300°F)	-34°C to 121°C (-30°F to 250°F), N0674-70, nitrile -29°C to 135°C (-20°F to 275°F), N0951-75, nitrile -54°C to 135°C (-65°F to 275°F), N0756-75, nitrile -26°C to 204°C (-15°F to 400°F), V1164-75, fluorocarbon -26°C to 204°C (-15°F to 400°F), V1226-75, fluorocarbon
Phosphate Esters Aircraft types (alkyl phosphate esters)	-54°C to 149°C (-65°F to 300°F)	E1267-80, ethylene propylene (NAS1613)
Phosphate Esters Industrial types (aryl phosphate esters)	-34°C to 93°C (-30°F to 200°F)	E0540-80, ethylene propylene V1164-75, fluorocarbon V1226-75, fluorocarbon
Phosphate Ester-Petroleum Oil Blends	-1°C to 100°C (30°F to 212°F)	V1164-75, fluorocarbon V1226-75, fluorocarbon
Silicate Esters	-54°C to 288°C (-65°F to 550°F)	-26°C to 204°C (-15°F to 400°F), V1164-75, fluorocarbon -26°C to 204°C (-15°F to 400°F), V0884-75, fluorocarbon -54°C to 149°C (-65°F to 300°F), C0873-70, neoprene
Silicone Hydraulic Fluids	-73°C to 288°C (-100°F to 550°F)	-73°C to 177°C (-100°F to 350°F), LM159-70 fluorosilicone (static only) -54°C to 149°C (-65°F to 300°F), E0540-80, ethylene propylene -26°C to 204°C (-15°F to 400°F), V1164-75, fluorocarbon -26°C to 204°C (-15°F to 400°F), V1226-75, fluorocarbon (brown Chromassure)
Water-Glycol	-18°C to 60°C (0°F to 140°F)	E0540-80, ethylene propylene N0674-70, nitrile (limited life as dynamic (But wider range seal anticipated above 43°C (110°F)) as a coolant) N0951-75, nitrile (for higher temperature coolant use)
Water-in-Oil Emulsions ("Invert" emulsions)	-12°C to 49°C (10°F to 120°F)	N0674-70, nitrile

Note: Due to variations in each type of fluid, and the many variables possible in the application of O-rings, these compound listings are intended only as general guides. Users must test under their own operating conditions to determine the suitability of any compound in a particular application.

Table 3-15: Compounds for Hydraulic Fluids
Properties of the Four Groups of Non-Flammable Fluids

Properties	Reference		
	HFA/HFB	HFC	HFD
kinematic viscosity (mm ² /s) to 50°C (122°F)	0.3 to 2	20 to 70	12 to 50
viscosity/temperature relationship	good	very good	bad
density at 15°C (59°F)	ca. 0.99	1.04 to 1.09	1.15 to 1.45
temperature range	3°C to 55°C (37°F to 131°F)	-25°C to 60°C (-13°F to 140°F)	-20°C to 150°C (-4°F to 302°F)
water content (weight %)	80 to 98	35 to 55	none
stability	emulsion poor solution very good	very good	very good
life of bearings	5 to 10%	6 to 15%	50 to 100%
heat transfer	excellent	good	poor
lubrication	acceptable	good	excellent
corrosion resistance	poor to acceptable	good	excellent
combustion temperature	not possible	after vaporizing of water under 1000°C (1832°F)	ca. 600°C (1112°F)
environmental risk	emulsion: used oil synth.: dilution	special waste	special waste
regular inspection	pH-level concentration water hardness micro-organisms	viscosity water content pH-level	viscosity neutral pH spec. gravity
seal material	NBR, FKM	NBR	FKM, EPDM⁽¹⁾

(1) only for pure (mineral oil free) phosphate-ester (HFD-R)

Table 3-16: Properties of the Four Groups of Non-Flammable Fluids

WARNING: These products can expose you to chemicals including carbon black (airborne and extracts), antimony trioxide, titanium dioxide, silica (crystalline), di(2-ethylhexyl) phthalate, ethylene thiourea, acrylonitrile, 1,3-butadiene, epichlorohydrin, toluenediisocyanate, tetrafluoroethylene, ethylbenzene, formaldehyde, furfuryl alcohol, glass fibers, methyl isobutyl ketone, nickel (metallic and compounds), lead and lead compounds which are known to the State of California to cause cancer; and 1,3-butadiene, epichlorohydrin, di(2-ethylhexyl)phthalate, di-isodecyl phthalate, ethylene thiourea, methyl isobutyl ketone, methanol, toluene, lead and lead compounds which are known to the State of California to cause birth defects and other reproductive harm. For more information go to www.P65Warnings.ca.gov.

3.9.17.2 Concentrates Containing Mineral Oils (Oil-in-Water-Solutions)

Oil is not soluble in water. Only by employing emulsifiers it is possible to bring about a stable oil-in-water-solution. The level of concentrates is limited by the stability of the emulsion.

Mineral oil concentrates can contain practically all types of chemical additives that have thus far been developed. When the water evaporates, mineral oil remains behind, containing all required anti-corrosion additives. The concentrates are mostly based on naphthenic oils and can cause problems with certain O-ring compounds. Such emulsions have been used as hydraulic press fluids for decades. In general, emulsions take longer to filter.

With these kinds of fluids there is a great risk of micro-bacteriological growth which can lead to problems. Such growth however, can be brought under control without difficulty by adding a biocide to the mixture.

3.9.17.3 Micro-Emulsions

Recently, new synthetic concentrates, which are similar to oils, have been developed which form micro-emulsions when mixed by 5% with water. This is neither a true *solution* nor an *emulsion*, but can be better described as a highly stable *colloidal suspension* of high viscosity oil drops in water.

The concentrate contains both water and oil soluble, wear resistant additives which form a high-pressure resistant film with good lubricating properties. They are not prone to the micro-biological attack, and have a useful life of more than one year.

Concentrates currently available at this time are limited to 100 Bar (1450 psi) working pressure and are mostly used in automated production lines, industrial robots, etc.

3.9.17.4 Synthetic HFA Concentrates (Solutions)

Recently a number of synthetic HFA concentrates have been developed which form a stable solution in water and are also suitable carriers of semi-soluble additives whose purpose is to protect metal components such as **brass and copper**.

These fluids can be filtered finely as required because they are in complete solution. Should the water evaporate however, the residual fluid has a high pH value, which may cause corrosion.

The most important physical properties of HFA fluids depend on their water proportion and vary greatly from mineral oils. As described above, wear and lubricating properties can be greatly improved by the addition of suitable concentrates. In spite of this, the working life of a hydraulic system using HFA fluid is significantly shorter than of a system using conventional hydraulic oils.

Oil based hydraulic systems are increasingly being replaced by HFA fluids. The tendency to leakage of these low-viscosity fluids has caused a search for additives that would increase the fluid's viscosity. The working temperature ranges from 5°C to 55°C (42°F to 130°F).

3.9.17.5 HFC Fluids

HFC hydraulic fluids consist of a solution of polyethylene and polypropylene glycols in a proportion of between 35% and 55%. The two glycols behave differently, bringing about a wide variation in the fluid's properties.

While polyethylene glycols exhibit relatively high resistance to shear, tests have shown that they suffer damage by shearing of the chains after only 2000 to 3000 working hours. Most elastomer compounds that are compatible with mineral oils also can be used in HFC fluids (NBR for example). Certain FKM compounds are not compatible with HFC fluids.

The wear resistant properties and viscosity of HFC fluids is good and corrosion may be controlled by additives. The temperature range is an improvement over mineral oil based fluids. Exposed bearings however, still remain very susceptible to corrosion due to high water content and the working life of equipment is thereby shortened. This is especially true with working pressures over 200 Bar (2900 psi).

HFC fluids are regarded as special refuse and should be handled accordingly. Working temperature ranges from -25°C to 60°C (-14°F to 140°F).

3.9.17.6 HFD Fluids

This group of hydraulic fluids consists of pure synthetic, water-free fluid and does not suffer from most of the previously mentioned difficulties. On the down side however, compatibility with most seal materials is rather limited.

The earliest developments in HFD fluids have disappeared from the market because they were extremely poisonous. Their place has been taken by pure phosphate esters, both synthetic and natural, which are essentially non-toxic. Although much easier to handle, these materials have a very steep viscosity/temperature relationship curve which makes the working range of temperature very narrow; this means that more cooling capacity is necessary to avoid overheating the system.

The fluid can be used at pressures in the range of 300 to 350 Bar (4350 to 5075 psi) and represents the most expensive hydraulic fluid on the market. Disposal is problem-free but must still be classified as special refuse.

HFD fluids can be used at temperatures between -20°C and 150°C (-5°F and 300°F).

3.10 Temperature Extremes

3.10.1 High Temperature

The fluorocarbons are the most useful for high temperature sealing applications. In a 1000 hour air age test at 204°C (400°F), Parker's fluorocarbon compound V0747-75 took a 66% set, leaving enough recovery to continue sealing for many additional hours at that temperature. At 232°C (450°F), however, the anticipated useful life is reduced to approximately 336 hours.

The effect of the environment must be carefully assessed. In the presence of hot water or steam, the fluorocarbons tend to harden and take a premature set. Under these conditions, ethylene propylene is generally superior to fluorocarbon.



WARNING: These products can expose you to chemicals including carbon black (airborne and extracts), antimony trioxide, titanium dioxide, silica (crystalline), di(2-ethylhexyl) phthalate, ethylene thiourea, acrylonitrile, 1,3-butadiene, epichlorohydrin, toluenediisocyanate, tetrafluoroethylene, ethylbenzene, formaldehyde, furfuryl alcohol, glass fibers, methyl isobutyl ketone, nickel (metallic and compounds), lead and lead compounds which are known to the State of California to cause cancer; and 1,3-butadiene, epichlorohydrin, di(2-ethylhexyl)phthalate, di-isodecyl phthalate, ethylene thiourea, methyl isobutyl ketone, methanol, toluene, lead and lead compounds which are known to the State of California to cause birth defects and other reproductive harm. For more information go to www.P65Warnings.ca.gov.

Compression Set Resistance of Compound N0951-75

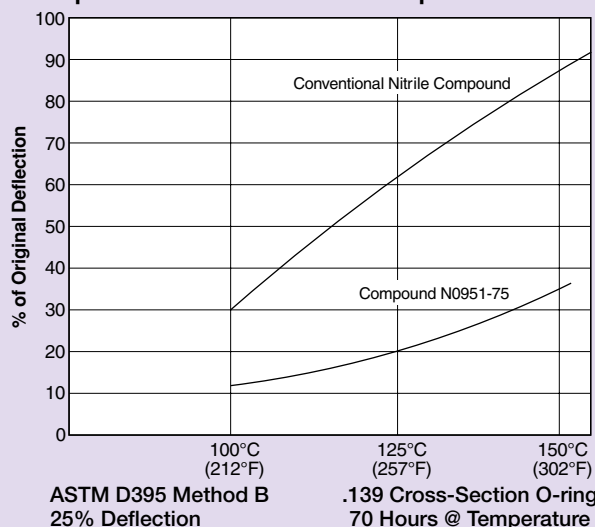

Figure 3-7: Compression Set Resistance of Compound N0951-75

High temperature silicones, such as Parker's S0455-70, appear superior to the fluorocarbons in air aging tests, but this is true only when the test specimen is exposed to circulating air.

Among the nitrile compounds that provide good resistance to petroleum fluids, adequate low temperature properties, good tensile strength, and good abrasion resistance for dynamic applications, compound N0951-75 has the best high temperature properties. It is recommended for temperatures up to 135°C (275°F) in air or petroleum oil. Its recommended low temperature limit is -32°C (-25°F). Figure 3-7, showing compression set values of this compound at various temperatures, demonstrates its fine high temperature capabilities.

Where media compatibility is not optimum, elevated temperatures are additionally dangerous. As a direct comparison, Table 3-18 shows the maximum long-term temperature limits in a compatible contact medium.

3.10.2 Low Temperature

When cooled, elastomer compounds lose their elasticity. At very low temperatures they harden and have glasslike brittleness, and may shatter if struck a sharp blow. As long as they are not mechanically disturbed, they remain intact, and upon return to normal temperatures, regain their original properties, the condition being fully reversible.

The low temperature flexibility of a given compound can be slightly improved if a contact medium causes swelling and softening. Softening can occur through adsorption of fluid that acts like a plasticizer.

As indicated by the Fluid Compatibility Tables in Section VII, silicone (S1224-70) and fluorosilicone (L1120-70) should be selected for low temperature applications. These compounds have poor wear resistance properties and are recommended only for static applications. Other elastomer types with good cold flexibility are CR, EPDM and special NBR compounds.

Comparison of Elastomers in a Compatible Contact Medium and Maximum Allowable

Compound DIN/ISO	Lubrication with mineral oil base	Temperatures in °C (°F)	
		Water	Air
1629 NBR	110°C (230°F)	70°C (158°F)	90°C (194°F)
High temperature NBR	120°C (248°F)	100°C (212°F)	100°C (212°F)
FKM	200°C (392°F) ⁽¹⁾	120°C (248°F) ⁽²⁾	200°C (392°F)
EPDM	not compatible	150°C (302°F) 200°C (392°F) ⁽⁵⁾	150°C (302°F)
VMQ	not compatible	100°C (212°F)	210°C (410°F)
FVMQ	175°C (347°F) ⁽¹⁾	100°C (212°F)	175°C (347°F)
ACM	150°C (302°F) ⁽¹⁾	— ⁽³⁾	150°C (302°F)
CR	100°C (212°F)	80°C (176°F) ⁽⁴⁾	90°C (194°F)

- (1) At these temperatures lubricants degrade after a short time.
- (2) Special compound.
- (3) High swelling at room temperature, hydrolysis at high temperatures.
- (4) Medium to high swelling according to temperature.
- (5) In water/steam.

Table 3-18: Comparison of Elastomers in a Compatible Contact Medium and Maximum Allowable Temperatures

The Fluid Compatibility Tables can be used only as a guideline. The actual lifetime of a seal at low temperature depends on the application and on the medium to be sealed.

Temperature at the TR-10 point should be taken for all elastomers to determine a minimum functional temperature.

In practice, a static seal may have a minimum functional temperature of about 15°C (-8°F) lower than the TR-10 point, assuming a correctly designed gland.

When air or other gases must be contained at temperatures below -54°C (-65°F) (the low temperature limit recommended for most silicones) compound S0383-70 may be used to reach temperatures to -115°C (-175°F) or lower.

If the permeability rate of silicones is thought to be too high for the application, bear in mind that the rate decreases as the temperature goes down. For applications requiring moderately high temperatures as well as low, it is sometimes feasible to use two O-rings, S0383-70 to maintain the seal at the extreme low temperature plus a butyl or fluorocarbon to reduce permeability when the seal is warmer.

If a low temperature seal must have resistance to a fluid that attacks silicone, the answer may be a fluorosilicone. This material has excellent resistance to a wide range of fluids, is usable up to 177°C (350°F) or higher in many applications, and will often seal at temperatures as low as -73°C (-100°F). Its primary disadvantage is its lack of toughness, giving it limited usefulness as a dynamic seal, yet in certain dynamic applications, fluorosilicone O-rings have served well as springs to activate a U-type shell of fluorocarbon elastomer or other wear resistant material.

Other compounds will often seal at temperatures below their normal low temperature limit by increasing the squeeze. This procedure, however, is generally limited to static face type designs, as a heavy squeeze makes a radial seal difficult to assemble.



WARNING: These products can expose you to chemicals including carbon black (airborne and extracts), antimony trioxide, titanium dioxide, silica (crystalline), di(2-ethylhexyl) phthalate, ethylene thiourea, acrylonitrile, 1,3-butadiene, epichlorohydrin, toluenediisocyanate, tetrafluoroethylene, ethylbenzene, formaldehyde, furfuryl alcohol, glass fibers, methyl isobutyl ketone, nickel (metallic and compounds), lead and lead compounds which are known to the State of California to cause cancer; and 1,3-butadiene, epichlorohydrin, di(2-ethylhexyl)phthalate, di-isodecyl phthalate, ethylene thiourea, methyl isobutyl ketone, methanol, toluene, lead and lead compounds which are known to the State of California to cause birth defects and other reproductive harm. For more information go to www.P65Warnings.ca.gov.

Where temperatures do not go below -40°C (-40°F), O-rings in Parker's low temperature fluorocarbon compound, VM835-75, can be utilized. Its other properties are similar to the standard fluorocarbon compounds. For temperatures down to -45°C (-50°F), Parker's V1289-75 should be considered.

The fluid medium often assists a low-temperature seal by acting as a plasticizer, keeping the elastomer soft and flexible below its normal low temperature limit. This low temperature benefit is most likely to occur in fluids that swell the elastomer.

For normal low temperature limits of several Parker Seal compounds, see Figure 2-3.

3.11 Vacuum Applications

Butyl rubber has long been the preferred material for vacuum applications. Among the rubber polymers used for seals, it has one of the lowest permeability rates for gases. This, together with the fact that butyl compounds have low outgassing or weight loss characteristics, good physical properties for a seal, a useful temperature range of -59°C to 121°C (-75°F to 250°F), and good moisture resistance, has established this preferred position. The need for special environmental considerations in addition to low permeability will often change the recommendation. Service requirements such as high temperature, radiation resistance, long term exposure to water or combinations of fluid media may take a careful study to determine the proper recommendation.

3.11.1 Vacuum Weight Loss

It is particularly important in many space and other vacuum applications that optical surfaces and electrical contact surfaces remain clean to serve their intended purpose. Some rubber compounds contain small quantities of oil or

other ingredients that become volatile under high vacuum conditions and deposit as a thin film on all the surrounding surfaces. Table 3-19 indicates the weight loss of several Parker Seal compounds due to vacuum exposure. Where sensitive surfaces are involved, the higher weight loss compounds should be avoided.

In those compounds which show low weight loss, the small amount of volatile material that is indicated is primarily water vapor. It is not likely to deposit on nearby surfaces.

3.11.2 Vacuum Seal Considerations

The rate of flow of gases from the pressure side to the vacuum side of an elastomeric seal depends to a great extent on how the seal is designed. Compound B0612-70 has been tested in face type O-ring seals, using grooves that provided 15%, 30% and 50% squeeze. It will be seen from the results plotted in Figure 3-8 that increasing the squeeze reduced the leak rate dramatically. Lubricating the O-rings with a high vacuum grease also reduced the leakage of the lightly squeezed (15%) rings significantly, but the effect of the grease was considerably less at 30% squeeze. At 50% squeeze the effect of the grease was not detectable. Several other compounds were tested in this way with similar results.

Increased O-ring squeeze reduces permeability by increasing the length of the path the gas has to travel (width of ring) and decreasing the area available to the entry of the gas (groove depth). Increasing the squeeze also tends to force the rubber into any small irregularities in the mating metal surface, and thus prevents leakage around the seal. The vacuum grease aids the seal by filling these microscopic pits and grooves, thus reducing leakage around the ring, and at the same time it may be changing the surface tension favorably with the effect of a reduced rate of surface absorption.

Weight Loss of Compounds in Vacuum		
Test Samples: Approximately .075" thick		
Vacuum Level: Approximately 1 x 10 ⁻⁶ torr		
Time: 336 hours (two weeks)		
Room Temperature		
Compound Number	Polymer	Percent Weight Loss
B0612-70	Butyl	.18
C0873-70	Neoprene	.13
E0515-80	Ethylene Propylene	.39
E0529-60	Ethylene Propylene	.92
E0692-75	Ethylene Propylene	.76
L0449-65	Fluorosilicone	.28
L0677-70	Fluorosilicone	.25
N0406-60	Nitrile	3.45
N0674-70	Nitrile	1.06
P0648-90	Polyurethane	1.29
S0455-70	Silicone	.03
S0604-70	Silicone	.31
V0747-75	Fluorocarbon	.09
V0884-75	Fluorocarbon	.07
V0894-90	Fluorocarbon	.07

Note: Some of these compounds may no longer be available.

Table 3-19: Weight Loss of Compounds in Vacuum

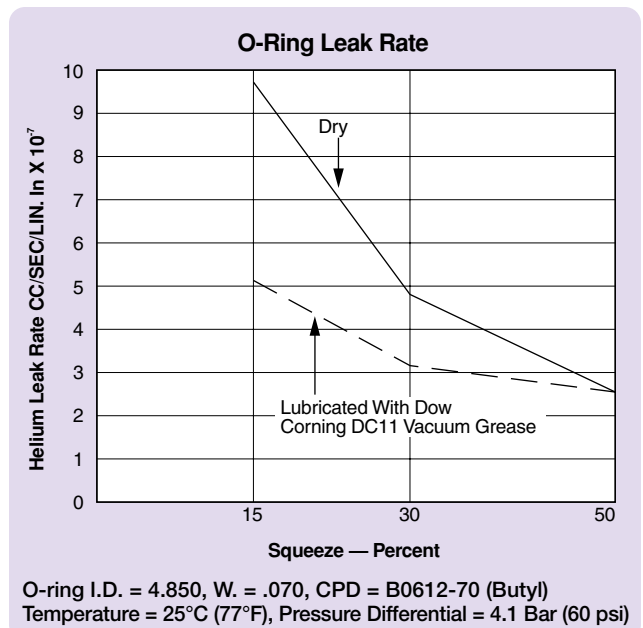

Figure 3-8: O-Ring Leak Rate

WARNING: These products can expose you to chemicals including carbon black (airborne and extracts), antimony trioxide, titanium dioxide, silica (crystalline), di(2-ethylhexyl) phthalate, ethylene thiourea, acrylonitrile, 1,3-butadiene, epichlorohydrin, toluenediisocyanate, tetrafluoroethylene, ethylbenzene, formaldehyde, furfuryl alcohol, glass fibers, methyl isobutyl ketone, nickel (metallic and compounds), lead and lead compounds which are known to the State of California to cause cancer; and 1,3-butadiene, epichlorohydrin, di(2-ethylhexyl)phthalate, di-isodecyl phthalate, ethylene thiourea, methyl isobutyl ketone, methanol, toluene, lead and lead compounds which are known to the State of California to cause birth defects and other reproductive harm. For more information go to www.P65Warnings.ca.gov.

It is recommended, therefore, that face type O-ring grooves be used whenever possible for static vacuum seals, using a silicone grease as a seating lubricant and surface coating in addition to a heavy squeeze of the O-ring cross section. When a radial seal is required, or when a heavy squeeze is not possible for some other reason, it becomes more important to use a vacuum grease.

As an example of the benefit of high squeeze, we have found that Gask-O-Seals and Integral Seals both make effective vacuum seals because of the generous squeeze that is built into them. Gask-O-Seals have the added advantage of a high percent fill of the groove together with a shallow depth which reduces the seal area that can be exposed to the effects of vacuum, and prevents the rubber sealing element from moving due to vibration or pressure changes. An additional benefit of high percentage confinement is the fact that increased temperatures do not increase the leak rate as much as normally expected with a lesser confinement.

Although a very heavy squeeze is necessary to reduce leakage to an absolute minimum in an O-ring seal, this kind of design may require heavy construction. When such a shallow gland is desirable, it must be wide enough to receive the full O-ring volume.

For most purposes, the gland design shown for vacuum and gasses in Design Chart 4-2 is a reasonable compromise in a face seal situation. The squeeze recommended in that design chart, however, is sufficiently heavy that a male or female gland assembly with the same dimensions may be very difficult to assemble. For these, then, Design Chart 4-1 and Design Table 4-1 are generally followed.

There is very little data available on dynamic vacuum seals, but reasonably low leak rates have been reported using two O-ring seals designed according to Design Chart 5-2 and Design Table 5-2. In sealing gases and vacuum, it is quite feasible to use two O-ring seals in tandem, unlike reciprocating applications that seal a liquid, where pressure traps are often a problem.

Surface roughness of the gland surfaces is more critical in sealing pressurized gases or vacuum, as a gas will find its way through extremely minute passages. Therefore, surfaces against which an O-ring must seal should have a surface roughness value smoother than usual. Surface finishes of 16 RMS are quite common, but 32 RMS finishes have been used successfully also.

3.11.3 Vacuum Leak Rate

To determine approximate leak rate for a vacuum seal, use the "Leak Rate Approximation" method in the section on Gases. Note that where the external pressure is one atmosphere, the pressure differential across the seal (P) is 14.7 psi.

Many parameters should be observed to seal a vacuum. In general apply the following recommendations:

- Select correct O-ring compound;
- The surfaces to be sealed and the gland must have a significantly better surface finish than for "normal" seals Table 3-20;
- The O-ring should fill the gland (nearly 100%, Figure 3-9). Larger contact areas are thereby created and the diffusion rate through the elastomer is slowed;
- To increase efficiency, two seals can be fitted in tandem in separate glands;
- The total leakage rate is reduced using a suitable vacuum grease.

Requirements for the O-ring compound are:

- Low gas permeation rate
- Good, i.e. low compression set
- Compatibility of medium
- Temperature compatibility
- Low weight loss in vacuum

For more detailed information see Rate of gas leakage.

Surface Finish of Vacuum Gland

	Surface Roughness of Vacuum Gland Load Area $t_p > 50\%$			
	A Contact Area		B Gland Flanks	
	R_a	R_{max}	R_a	R_{max}
Vacuum	0.8	3.2	1.6	6.3
to 10^{-9} Torr	0.4	1.6	1.6	6.3
to 10^{-11} Torr	0.10	0.40	1.6	6.3

Table 3-20 Surface Finish of Vacuum Gland (See also Figure 3-9)

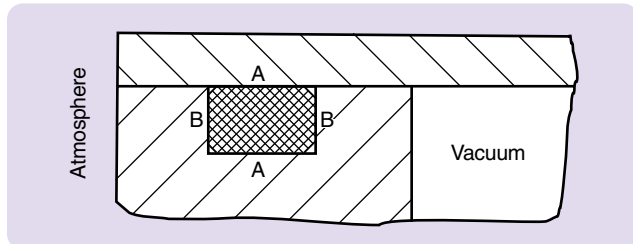

Figure 3-9: Vacuum O-ring Gland

3.12 Gases-Permeability

All elastomers are permeable to some extent, allowing air, other gases under pressure or volatile liquids to penetrate into the seal material and gradually escape on the low pressure side.

The permeability rate of various gases through different rubber materials varies in an unpredictable way. In fact, the permeability of a given base polymer will vary according to the proportions of the copolymer, among other things. Figure 3-10 shows this very clearly for one class of butadiene-acrylonitrile copolymers.

The permeability also varies with temperature, and though the rate increases with increasing temperature, there is no easily defined relationship between these two variables. Table 3-24 (found at the end of this section) lists some permeability rates at various temperatures that may be helpful in approximating leak rates through O-ring seals.

WARNING: These products can expose you to chemicals including carbon black (airborne and extracts), antimony trioxide, titanium dioxide, silica (crystalline), di(2-ethylhexyl) phthalate, ethylene thiourea, acrylonitrile, 1,3-butadiene, epichlorohydrin, toluenediisocyanate, tetrafluoroethylene, ethylbenzene, formaldehyde, furfuryl alcohol, glass fibers, methyl isobutyl ketone, nickel (metallic and compounds), lead and lead compounds which are known to the State of California to cause cancer; and 1,3-butadiene, epichlorohydrin, di(2-ethylhexyl)phthalate, di-isodecyl phthalate, ethylene thiourea, methyl isobutyl ketone, methanol, toluene, lead and lead compounds which are known to the State of California to cause birth defects and other reproductive harm. For more information go to www.P65Warnings.ca.gov.

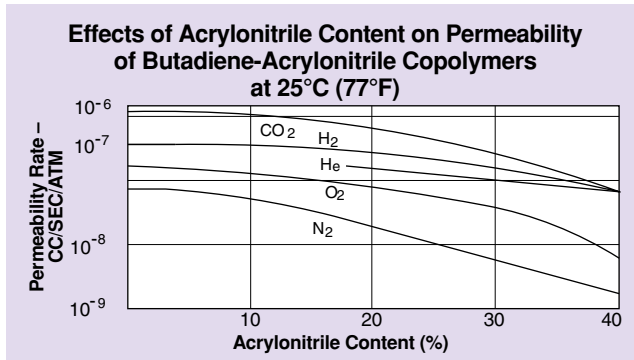

Figure 3-10: Effect of Acrylonitrile Content on Permeability of Butadiene-Acrylonitrile Copolymers at 25°C (77°F) from "Gas Permeability of Hycar Polymers" by B. F. Goodrich Company

3.12.1 Leak Rate Approximation

The leak rate of a gas through an O-ring seal may be roughly approximated when the permeability of the gas through the particular elastomer is known for the temperature at which the seal must function. The following formula is useful for this approximation:

$$L = 0.7 F D P Q (1-S)^2$$

where

- L = Approximate leak rate of the seal, std. cc/sec.
- F = Permeability rate of the gas through the elastomer at the anticipated operating temperature, std. cc cm/cm² sec bar (Many of these permeability rates are listed in Table 3-18, found at the end of this section)
- D = Inside diameter of the O-ring, inches.
- P = Pressure differential across the seal, lb/in²
- Q = Factor depending on the percent squeeze and whether the O-ring is lubricated or dry (from Figure 3-11)
- S = Percent squeeze on the O-ring cross section expressed as a decimal. (i.e., for a 20% squeeze, S = .20)

This formula gives only a rough order of magnitude approximation because permeability varies between compounds in the same polymer, and because the assumptions on which it is based are not all exact.

These assumptions are:

1. The cross section of a squeezed O-ring is rectangular.
2. The cross section area of a squeezed O-ring is the same as its area in the free condition.
3. The permeability rate of a gas through an O-ring is proportional to the pressure differential across the seal.

For convenience, the formula contains mixed units. It was set up this way because in the United States O-ring diameters are usually given in inches, and pressures in pounds per square inch while permeability figures are usually shown in metric units. The 0.7 factor resolves these inconsistencies.

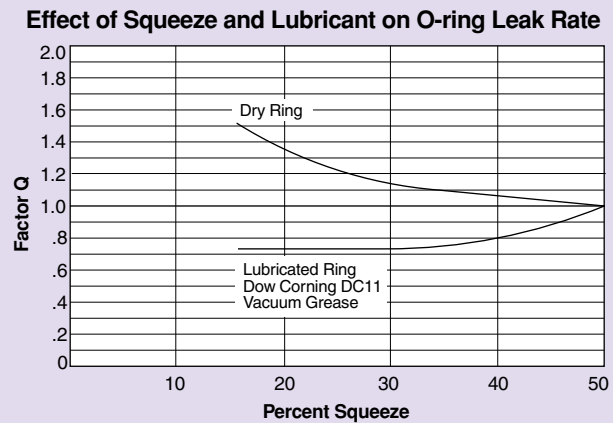

For helium leak rate, a variation of ±50% from the predicted value should be anticipated to allow for limitations in the accuracy of test equipment and available standards, and for variations between samples.

Figure 3-11: Effect of Squeeze and Lubricant on O-Ring Leak Rate

3.13 Gases-High Pressure

Because all elastomers are permeable, gases under pressure penetrate into the seal material. Naturally, the greater the pressure, the larger the quantity of gas forced into the rubber. When gas pressure around a seal is released after a soak period, gas trapped inside the seal expands and may escape harmlessly into the atmosphere, or it may form blisters on the surface. Some of these may rupture, leaving cracks or pits. This phenomenon is called explosive decompression.

The severity of the damage varies with pressure, the gas, the rubber compound, the size of the cross section, and other factors, such as pressure drop rate.

We rarely see problems when the pressure is below 27.6 Bar (400 psi), and generally carbon dioxide causes more swelling and damage than does nitrogen, as mentioned, although any pressurized gas may cause the condition. As mentioned, elevated temperature increases the damage, as does a rapid rate of pressure drop.

Where problems due to explosive decompression are anticipated, it may help to use a small cross section O-ring, as smaller cross sections are less subject to explosive decompression problems than are large ones.

In laboratory tests, it was found that soaking compound N0304-75 in MIL-H-5606 oil for 24 hours at 135°C (275°F) prior to testing dramatically curtailed the severity of the damage, presumably because the oil permeates the rubber and reduces the amount of gas that can enter. This principle should be helpful in many applications.

WARNING: These products can expose you to chemicals including carbon black (airborne and extracts), antimony trioxide, titanium dioxide, silica (crystalline), di(2-ethylhexyl) phthalate, ethylene thiourea, acrylonitrile, 1,3-butadiene, epichlorohydrin, toluenediisocyanate, tetrafluoroethylene, ethylbenzene, formaldehyde, furfuryl alcohol, glass fibers, methyl isobutyl ketone, nickel (metallic and compounds), lead and lead compounds which are known to the State of California to cause cancer, and 1,3-butadiene, epichlorohydrin, di(2-ethylhexyl)phthalate, di-isodecyl phthalate, ethylene thiourea, methyl isobutyl ketone, methanol, toluene, lead and lead compounds which are known to the State of California to cause birth defects and other reproductive harm. For more information go to www.P65Warnings.ca.gov.

3.14 Acids

Resistance of elastomeric compounds to acids often changes dramatically with temperature and with concentration.

In strong solutions, the acid resistant fluorocarbon compound often maintains its properties rather well, particularly at room temperature. In the Fluid Compatibility Table in Section VII, it is shown as the only compound that is likely to withstand the effects of concentrated nitric and hydrochloric acids at room temperature. At higher temperatures in these acids, only a perfluoroelastomer can be expected to maintain a seal on a long term basis.

In dilute solutions, an ethylene propylene compound is usually preferred, particularly if there is any elevated temperature involved, because ethylene propylene has excellent resistance to water as well as quite good acid resistance.

It is particularly important to test seal compounds under service conditions when a strong acid is to be sealed at elevated temperatures.

3.14.1 Plastic Contact Surfaces

Sometimes when an O-ring is used in contact with a plastic material, the plastic will develop a series of fine cracks that weaken it. This “crazing” has been noticed most frequently with polycarbonate resins, such as General Electric’s Lexan, but it has also been found in other plastic materials.

This effect is most severe when the plastic material is under the greatest stress, and may be caused by stress alone. For instance, compounds E0515-80, N0522-90 and V0709-90 were rated “marginal,” but we feel that the problem with these elastomers may have been caused by their hardness, as we would not expect a chemical effect between them and a polycarbonate resin.

General Electric Company has tested a number of Parker Seal Compounds with Lexan and found that the following materials are generally acceptable in contact with Lexan. See Table 3-21.

Compounds for Use Against Lexan⁽¹⁾ Surfaces

Ethylene Propylene	Fluorocarbon
E0692-75 (marginal)	V0680-70
E0515-80 (marginal)	V0747-75
Nitrile	V0709-90 (marginal)
N0602-70	Neoprene
N0674-70	C0267-50
N0304-75	C0557-70
N0508-75	Polyurethane
N0741-75	P0642-70
N0506-65 (marginal)	Silicone
47-071 (marginal)	S0317-60
N0552-90 (marginal)	S0469-40
	S0604-70

(1) General Electric Trademark

Note: Some of these compounds may no longer be available.

Table 3-21: Compounds for Use Against Lexan Surfaces

3.14.2 Silicone Fluids

Silicone fluids are chemically very stable. Reference to the Fluid Compatibility Table in Section VII, for instance, shows that all types of seal polymers except silicone rubber may be used for silicone oils and greases. There are some individual compound exceptions.

Silicone fluids have a great tendency to remove plasticizer from compounds, causing them to shrink. The effect is most severe with the combination of low viscosity silicone fluids in high temperature environments. Because of this, military nitrile compounds, and any other nitriles with a low temperature limit below -40°C (-40°F) should not be used to seal silicone fluids as such low temperature nitriles must contain large amounts of plasticizers. Other compounds, including the high temperature nitriles, should be tested before use to be certain they will not shrink more than one or two percent.

Silicone rubber is rated 3 (doubtful) in contact with silicone fluids. The poor rating is given because silicone rubber tends to absorb silicone fluids, resulting in swelling and softening of the rubber. Occasionally, however, it is desirable to seal a silicone fluid with a silicone rubber O-ring. This combination is generally acceptable if the viscosity of the silicone fluid is 100,000 centistokes or more, and if the maximum temperature will not exceed 149°C (300°F).

3.14.3 Underwriters’ Laboratories

Common Parker compounds are listed by Underwriters’ Laboratories (UL) under their “Recognized Compound Program.” The listing is based on UL testing of compound for specific service requirements as shown in Table 3-22.

3.14.4 Water and Steam Resistance

Water seems like such an innocuous fluid; people are often surprised to learn that it can bring problems if it is not sealed with the proper O-ring material.

After a long period of water immersion, many compounds will swell quite drastically. In a static seal, this may be quite acceptable. Such a seal surely will not leak, and if it can be replaced with a new one after disassembly, the fact that it has become too large to put back into the gland cavity becomes only an interesting curiosity. In situations where the O-rings are routinely replaced before they have swelled more than a few percent, the user may not even be aware of their strange behavior. Used as a long-term dynamic seal, however, this gradual swelling of many compounds in water can cause a slow but very annoying increase in both breakout and running friction.

Figure 3-12 and Figure 3-13 illustrate this gradual swelling of a number of Parker Seal compounds when exposed to water at two different temperatures. From these curves it will be seen that E0540-80 ethylene propylene rubber is the single compound tested that had virtually no swell. This is our recommended compound for water and steam for temperatures up to 149°C (300°F). Where exposure to steam and hot air alternate, as in tire presses, it serves better than in either one alone.



WARNING: These products can expose you to chemicals including carbon black (airborne and extracts), antimony trioxide, titanium dioxide, silica (crystalline), di(2-ethylhexyl) phthalate, ethylene thiourea, acrylonitrile, 1,3-butadiene, epichlorohydrin, toluenediisocyanate, tetrafluoroethylene, ethylbenzene, formaldehyde, furfuryl alcohol, glass fibers, methyl isobutyl ketone, nickel (metallic and compounds), lead and lead compounds which are known to the State of California to cause cancer; and 1,3-butadiene, epichlorohydrin, di(2-ethylhexyl)phthalate, di-isodecyl phthalate, ethylene thiourea, methyl isobutyl ketone, methanol, toluene, lead and lead compounds which are known to the State of California to cause birth defects and other reproductive harm. For more information go to www.P65Warnings.ca.gov.

Underwriters' Laboratories Approved Services

Service	A	B	C	D	E	F	G	H	I	J	L	M				
EA454-50 (3575)																
KA170-55 (21105)																
LM159-70																
N0299-50																
N0497-70																
N0674-70																
N1499-70																
N1585-70																
N1500-75																
N1591-75 (67357)																
NF162-65 (1106)																
N1565-75 (67027)																
N1527-70 (67147)																
V0747-75																
VA151-75 (19357)																
V0884-75																
V1163-75																
V1226-75																
V1262-65																
V1263-75																
V1436-75																

*Contact factory for specific ratios of alcohol (methyl and/or ethyl) and gasoline.
 Note: Material certifications are subject to change. Please contact Parker's O-Ring Division for more information.

Table 3-22: Underwriters' Laboratories – JMLU2 – Gaskets and Seals

For even greater resistance to steam, Parker has developed compound E0962-90. This ethylene propylene compound showed very little change in physical properties after 70 hours exposure to steam at 288°C (550°F).

With sealing steam or water with ethylene propylene rubber, it is important to remember that it will deteriorate when exposed to petroleum lubricants. When lubrication is required, silicone oil, glycerin, or ethylene glycol are suggested.

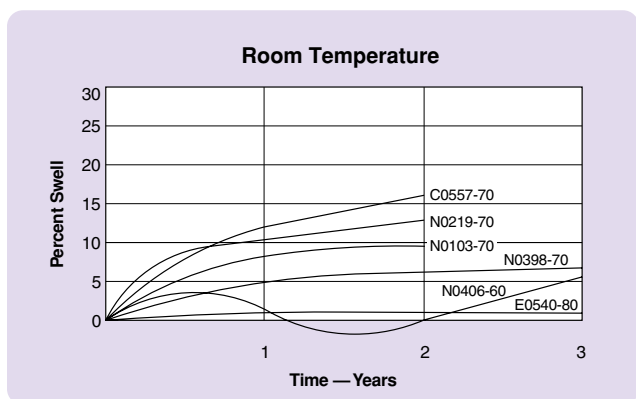

Figure 3-12: Water and Steam Resistance at Room Temperature

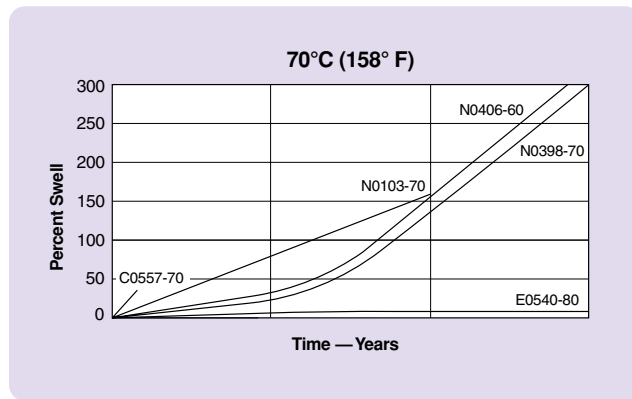

Figure 3-13: Water and Steam Resistance at 70°C (158°F)

WARNING: These products can expose you to chemicals including carbon black (airborne and extracts), antimony trioxide, titanium dioxide, silica (crystalline), di(2-ethylhexyl) phthalate, ethylene thiourea, acrylonitrile, 1,3-butadiene, epichlorohydrin, toluenediisocyanate, tetrafluoroethylene, ethylbenzene, formaldehyde, furfuryl alcohol, glass fibers, methyl isobutyl ketone, nickel (metallic and compounds), lead and lead compounds which are known to the State of California to cause cancer; and 1,3-butadiene, epichlorohydrin, di(2-ethylhexyl)phthalate, di-isodecyl phthalate, ethylene thiourea, methyl isobutyl ketone, methanol, toluene, lead and lead compounds which are known to the State of California to cause birth defects and other reproductive harm. For more information go to www.P65Warnings.ca.gov.

3.15 Semiconductor

The semiconductor industry is utilizing increased levels of toxic fluids and gases, which place extreme demands upon seal design and materials. Not only to prevent system contamination from the external environment, but they must not contribute any contaminants to the system in their own right. Specific needs are required by each of the four primary environments employed by the semiconductor industry:

- Gases & Vacuum
- Thermal
- Plasma
- Wet Processing

Working conditions:

Temperatures: up to 300°C (572°F)
 Pressures: vacuum to 10⁻⁹

Contact our Application Engineering Department regarding Semiconductor sealing applications.

3.16 inPHorm Seal Design and Material Selection Software

Parker recommends utilizing our inPHorm design software to guide the user through the design and selection of an O-ring and corresponding seal gland. Parker's inPHorm not only addresses standard o-ring sizes, but will allow the user to custom design O-ring glands and seals specifically for their application. To obtain inPHorm software contact the O-Ring Division, Parker Product Information at 1-800-C-PARKER or download from www.parkerorings.com. If inPHorm is not readily available manual calculations can be performed.

3.17 Drive Belts

3.17.1 Introduction

O-rings and lathe-cut rings are being used extensively as low power drive belts because they are inexpensive and simple to install. Due to their resilient nature, they do not require the use of belt tensioning devices, and pulley locations do not need to be extremely accurate.

For most elastic drive belt applications, O-rings are preferred over lathe-cut rings for a number of reasons:

- (a) Ease of installation.
- (b) Uniform stress distribution.
- (c) Ready availability of many standard sizes.
- (d) Flexibility of usage.
- (e) No sharp corners on the belt.

Lathe-cuts are often completely adequate for the task, but they are more likely to require special tooling, making the cost prohibitive when only a small quantity is needed. For large quantities, the tooling cost becomes insignificant, and overall cost savings are generally realized in using lathe-cut rings. Due to the special manufacturing techniques employed, all lathe-cut applications are reviewed by the O-Ring Division's Application Engineering Department.

Parker Seal is conducting a continuing program of testing compounds for drive belt service, and developing new drive belt compounds to optimize the properties that are most

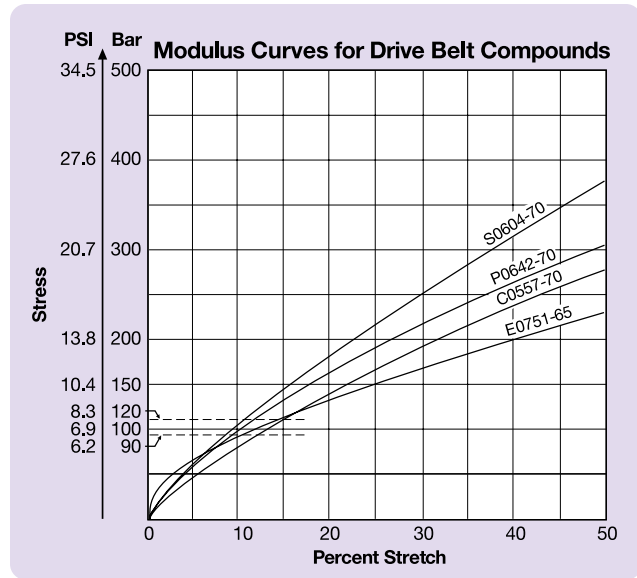

Figure 3-14: Modulus Curves for Drive Belt Compounds

needed in a drive belt. Minimum stress relaxation and maximum flex life are especially important in a drive belt, but several compounds must be available to provide resistance to the various fluids and temperature ranges that may be encountered.

3.17.2 Drive Belt Compound Selection

An O-ring compound intended for drive belt service should be selected for minimum stretch relaxation (tensile set) and maximum dynamic properties.

The choice of elastomer is determined by the physical environment:

- Contact medium, ozone, oil, grease.
- Service temperatures.

The general requirements for elastomer drive belt materials are:

- Good aging resistance.
- Wear resistance.
- Relatively low tendency to return to original shape under tension and temperature caused by friction; this means a higher resistance to the Joule effect.
- Good flexibility.

3.17.3 Available Drive Belt Compounds

The information below describes the most suitable drive belt compounds available. The Application Engineering Department should be contacted for additional information.

E0751-65 has been developed specifically for drive belt use. Performance data from production samples show that it has properties superior to O-ring compounds recommended formerly, and E0751-65 has become the "standard" drive belt compound as a result. The most important of its properties are low stress relaxation combined with reliability and resistance to high temperature. A limitation that prevents its use in a few applications is its lack of resistance to petroleum fluids.

WARNING: These products can expose you to chemicals including carbon black (airborne and extracts), antimony trioxide, titanium dioxide, silica (crystalline), di(2-ethylhexyl) phthalate, ethylene thiourea, acrylonitrile, 1,3-butadiene, epichlorohydrin, toluenediisocyanate, tetrafluoroethylene, ethylbenzene, formaldehyde, furfuryl alcohol, glass fibers, methyl isobutyl ketone, nickel (metallic and compounds), lead and lead compounds which are known to the State of California to cause cancer; and 1,3-butadiene, epichlorohydrin, di(2-ethylhexyl)phthalate, di-isodecyl phthalate, ethylene thiourea, methyl isobutyl ketone, methanol, toluene, lead and lead compounds which are known to the State of California to cause birth defects and other reproductive harm. For more information go to www.P65Warnings.ca.gov.

Parker Seal Elastic Drive Belt Compound Data⁽¹⁾

	Compound Number Specific Gravity, G	DBA ⁽⁶⁾ E0751-65 1.13	DBA ⁽⁶⁾ P0642-70 1.29	DBA ⁽⁶⁾ C0557-70 1.47	DBA ⁽⁶⁾ S0604-70 1.43
Dynamic Stress Relaxation ⁽²⁾					
Initial Stress, 120 PSI		13%	19%	14%	21%
	Temp °C (°F)				
Static Stress Relaxation ⁽³⁾	24 (75)	14%	21%	14%	2%
Initial Stress, 120 PSI	66 (150)	18%	29%	19%	5%
	82 (180)	20%	36%	22%	2%
Flex Life Rating		Good	Excellent	Acceptable	Excellent
Maximum Temperature, °C (°F)		82 (180)	54 (130)	82 (180)	149 (300)
Hardness, Shore A, Durometer		65±5	70±5	70±5	70±5
Tensile Strength, Bar (PSI)		135.9 (1970)	302.2 (4380)	138.0 (2000)	62.1 (900)
Elongation, %		385	535	250	160
Modulus @ 100%, Elongation, Bar (psi)		30.4 (440)	29 (420)	38.0 (550)	41.1 (600)
Resistance to: ⁽⁴⁾					
Petroleum Fluids		Poor	Excellent	Good	Poor
Silicone Fluids		Excellent	Excellent	Excellent	Poor
Water		Excellent	Fair	Good	Good
Ozone		Excellent	Excellent	Good	Excellent
Abrasion		Good	Excellent	Good	Poor

(1) All values shown are typical. Do not use for specification limits. Specimens: 2-153 O-rings.

(2) After three days dynamic testing at room temperature Motor pulley pitch diameter: .611", speed: 1740 rpm. Cast iron driven pulley pitch diameter: 2.623".

Duty cycle 3 minutes on, 15 seconds off. Load: inertia of cast iron pulley.

(3) After 48 hours static testing at temperature indicated. Two ½" diameter pulleys.

(4) For information on resistance of these materials to other fluids, see Fluid Compatibility Table in Section VII.

(5) When ordering parts for drive belt applications, the letters "DBA" precede the part number. Example: DBAS0604-70 2-250.

Table 3-23: Parker Seal Elastic Drive Belt Compound Data

Some O-ring seal compounds have been used successfully in many drive belt applications. The three materials described below have been evaluated specifically for this type of use and gave superior performance under the conditions stated:

P0642-70 has been a very successful material for drive belt applications. It is recommended for severe conditions where extra abrasion resistance, long life, and high stress values are required and service temperatures do not exceed 54°C (130°F). Its major attribute is reliability, which is due to the excellent flow characteristics of polyurethane that minimize the possibility of poor knitting. It is a particularly tough material, having high tensile strength and excellent resistance to abrasion, wear, and fatigue.

C0873-70 is recommended where the service temperature exceeds 54°C (130°F) and there is a possibility of contact with petroleum fluids. It has outstanding resistance to stress relaxation at temperatures as high as 82°C (180°F), though its resistance to fatigue is not as good as other Parker drive belt compounds.

S0604-70 is the compound generally selected for high temperature use or for applications where the black color of the other drive belt compounds is not permissible. Being a silicone, however, it does not have the tensile strength or resistance to wear and abrasion of the other compounds. The user, therefore, should not sacrifice these important properties by specifying an unrealistically high temperature to provide a "safety factor". Usually some excess temperature can be tolerated if the exposure time is of short duration and is repeated only a few times during the life of the drive belt. It should be remembered that the physical properties of any compound will be poorer at elevated temperature.

Table 3-23 compares the important properties of these rubber materials. Specific gravity and stress relaxation are listed first

because these data are needed in drive belt design. When drive belts may contact fluids not listed in Table 3-23, refer to the Fluid Compatibility Tables in Section VII. In any case, contact of elastomeric drive belts with any liquid must be kept to an absolute minimum. Almost any liquid on the belt will reduce friction, causing slippage. Since contact with fluids is seldom encountered in drive belt practice, this becomes a minor consideration.

3.18 Applications Summary

In the foregoing discussions on special applications, there are necessarily many references to problems and failures, but the object of pointing out possible pitfalls is to indicate to the designer the steps he can take to avoid them. The object of this whole reference manual, then, is the very positive one of showing how to produce reliable, economical, effective O-ring seals for a diversity of uses.

An important factor in most O-ring seals is the rubber compound from which it is made. For the special applications presented in this chapter, many specific compound recommendations are included. Parker Compound recommendations based on fluid type alone will be found in the Fluid Compatibility Tables in Section VII.

It is an excellent practice, after selecting one or more likely materials, to study those portions of the Elastomers section that apply to that material. Background information is given there that will give the designer a better understanding of the general properties of each of the major polymers, and help him select wisely when a choice or compromise must be made. The explanations of physical properties and how they are tested are also necessary for an adequate understanding of rubber materials and their behaviour in different operating environments.



WARNING: These products can expose you to chemicals including carbon black (airborne and extracts), antimony trioxide, titanium dioxide, silica (crystalline), di(2-ethylhexyl) phthalate, ethylene thiourea, acrylonitrile, 1,3-butadiene, epichlorohydrin, toluenediisocyanate, tetrafluoroethylene, ethylbenzene, formaldehyde, furfuryl alcohol, glass fibers, methyl isobutyl ketone, nickel (metallic and compounds), lead and lead compounds which are known to the State of California to cause cancer; and 1,3-butadiene, epichlorohydrin, di(2-ethylhexyl)phthalate, di-isodecyl phthalate, ethylene thiourea, methyl isobutyl ketone, methanol, toluene, lead and lead compounds which are known to the State of California to cause birth defects and other reproductive harm. For more information go to www.P65Warnings.ca.gov.

Gas Permeability Rates

Gas or Liquid	Elastomer	Temperature		Permeability ⁽¹⁾ x 10 ⁻⁸	Source ⁽²⁾
		°C	°F		
Acetone	Silicone	25	77	14,850	I
Acetylene	Butyl	25	77	1.26	I
Acetylene	Butyl	50	122	5.74	I
Acetylene	Natural	25	77	74.5	I
Acetylene	Natural	50	122	192	I
Acetylene	Nitrile	25	77	18.7	I
Acetylene	Nitrile	50	122	67.4	I
Air	Butyl	Room		0.2	DC
Air	Butyl	200	392	100	DC
Air	Fluorosilicone	Room		48.4	DC
Air	Natural	Room		6.7	DC
Air	Natural	200	392	262	DC
Air	Silicone	Room		18.0 to 25.6	DC
Air	Silicone	200	392	74	DC
Air	Polyurethane	Room		0.5	DC
Ammonia	Silicone	25	77	4396	I
Argon	Butyl (B0318-70)	35	95	1.19	A
Argon	Butyl (B0318-70)	82	180	9.04	A
Argon	Butyl (B0318-70)	124	255	36.1	A
Argon	Ethylene Propylene	38	100	11.3 to 22.9	A
Argon	Ethylene Propylene (E0529-65)	40	104	22.9	A
Argon	Ethylene Propylene (E0692-75)	38	100	15.58	A
Argon	Ethylene Propylene	93	200	57.0 to 108.7	A
Argon	Ethylene Propylene (E0529-65)	94	202	105	A
Argon	Ethylene Propylene (E0692-75)	93	199	77	A
Argon	Ethylene Propylene	149	300	170 to 375	A
Argon	Ethylene Propylene (E0529-65)	155	311	375	A
Argon	Ethylene Propylene (E0692-75)	149	300	280	A
Argon	Fluorocarbon-Viton ⁽⁴⁾	93	200	31	A
Argon	Natural	25	77	17.2	I
Argon	Neoprene	36	97	0.67	I
Argon	Neoprene	38	100	18	A
Argon	Neoprene	52	126	1.42	I
Argon	Neoprene	86	187	6.46	I
Argon	Nitrile	38	100	1.60 to 3.88	A
Argon	Nitrile (N0741-75)	39	103	2.06	A
Argon	Nitrile	79	175	6.39 to 16.7	A
Argon	Nitrile (N0741-75)	80	176	7.36	A
Argon	Nitrile	121	250	13.7 to 62.3	A
Argon	Nitrile (N0741-75)	118	245	34	A
Argon	Polyacrylate (A0607-70)	38	100	8.28	A
Argon	Polyacrylate (A0607-70)	91	195	40.66	A
Argon	Polyacrylate (A0607-70)	153	307	327	A
Argon	Polyurethane (P0642-70)	39	103	1.5	A
Argon	Polyurethane (P0648-90)	39	102	0.99	A
Argon	Polyurethane (P0642-70)	66	151	5.45	A
Argon	Polyurethane (P0648-90)	67	152	4.07	A
Argon	Polyurethane (P0642-70)	94	202	20.8	A
Argon	Polyurethane (P0648-90)	94	201	7.3	A
Argon	SBR	38	100	1.09 to 5.24	A
Argon	SBR (G0244-70)	38	101	5.24	A
Argon	SBR (G0244-70)	84	183	25.5	A
Argon	SBR (G0244-70)	122	251	138	A
Argon	Silicone	38	100	230 to 487	A

(1) Std cc cm/cm² sec. bar

(2) "I" denotes information from "Permeability Data for Aerospace Applications" funded by NASA and prepared by IIT Research Institute, March 1968.

"A" denotes information from Atomic International Division, Energy Systems Group, Rockwell International publication AI-AEC-13145,

"Design Guide for Reactor Cover Gas Elastomer Seals" March 7, 1975, and addendum, report ESC-DOE-13245, September 30, 1978.

"DC" denotes information from Dow Corning Bulletin 17-158, October 1972.

"P" denotes information from Parker Seal tests.

(3) "NR" Temperature not reported.

(4) Registered trademark E.I. du Pont de Nemours & Co.

Note: Some of these compounds may no longer be available.

Table 3-24: Gas Permeability Rates



WARNING: These products can expose you to chemicals including carbon black (airborne and extracts), antimony trioxide, titanium dioxide, silica (crystalline), di(2-ethylhexyl) phthalate, ethylene thiourea, acrylonitrile, 1,3-butadiene, epichlorohydrin, toluenediisocyanate, tetrafluoroethylene, ethylbenzene, formaldehyde, furfuryl alcohol, glass fibers, methyl isobutyl ketone, nickel (metallic and compounds), lead and lead compounds which are known to the State of California to cause cancer; and 1,3-butadiene, epichlorohydrin, di(2-ethylhexyl)phthalate, di-isodecyl phthalate, ethylene thiourea, methyl isobutyl ketone, methanol, toluene, lead and lead compounds which are known to the State of California to cause birth defects and other reproductive harm. For more information go to www.P65Warnings.ca.gov.

Gas Permeability Rates

Gas or Liquid	Elastomer	Temperature		Permeability ⁽¹⁾ x 10 ⁻⁸	Source ⁽²⁾
		°C	°F		
Argon	Silicone (S0684-70)	38	101	347	A
Argon	Silicone	93	200	454 to 1500	A
Argon	Silicone (S0684-70)	91	195	454	A
Argon	Silicone	149	300	566 to 2840	A
Argon	Silicone (S0684-70)	156	313	1020	A
Argon	Silicone	Room		450	I
Argon	PTFE	149	300	12	A
Benzene	Silicone	25	77	14300	I
Butane	Silicone	25	77	6750	I
Butane	Silicone	30	86	12980	I
Butane	Silicone	40	104	12380	I
Butane	Silicone	50	122	11630	I
Butane	Silicone	60	140	11030	I
Butane	Silicone	70	158	11330	I
iso-Butane	Silicone	30	86	7250 to 12980	I
iso-Butane	Silicone	40	104	7058 to 12380	I
iso-Butane	Silicone	50	122	6861 to 11630	I
iso-Butane	Silicone	60	140	6691 to 11030	I
iso-Butane	Silicone	70	158	6541 to 11330	I
Carbon Dioxide	Butadiene	25	77	36.3 to 103.6	I
Carbon Dioxide	Butadiene	30	86	103.5	I
Carbon Dioxide	Butadiene	50	122	197.4	I
Carbon Dioxide	Fluorosilicone	Room		514	DC
Carbon Dioxide	Fluorosilicone	26	79	444	I
Carbon Dioxide	Natural	25	77	98.3 to 116	I
Carbon Dioxide	Natural	30	86	98.3	I
Carbon Dioxide	Natural	50	122	218	I
Carbon Dioxide	Neoprene	22.3	72	9.98	I
Carbon Dioxide	Neoprene	25	77	13.9 to 19.2	I
Carbon Dioxide	Neoprene	30	86	14.0 to 18.8	I
Carbon Dioxide	Neoprene	50	122	47.6	I
Carbon Dioxide	Nitrile	20	68	5.63	I
Carbon Dioxide	Nitrile	30	86	47.7	I
Carbon Dioxide	Polysulfide	23	73	7.95	I
Carbon Dioxide	Polysulfide	25	77	2.37	I
Carbon Dioxide	Polyurethane	20	68	10.5	I
Carbon Dioxide	Polyurethane	30	86	5.4 to 30.0	I
Carbon Dioxide	Silicone	20.5	69	1028 to 1530	I
Carbon Dioxide	Silicone	25	77	2280	I
Carbon Dioxide	Silicone	32	90	1025 to 1545	I
Carbon Dioxide	Silicone	43.5	110	1043 to 1538	I
Carbon Dioxide	SBR	25	77	92.8	I
Carbon Dioxide	SBR	30	86	93.0	I
Carbon Dioxide	FEP PTFE	25	77	7.51	I
Carbon Monoxide	Butadiene	25	77	4.64	I
Carbon Monoxide	Natural	25	77	11.8	I
Carbon Monoxide	Silicone	Room		255	I
Carbon Tetrachloride	Silicone	Room		52500	I
Carbonyl Chloride	Silicone	Room		11250	I
Ethane	Butadiene	25	77	24.97	I
Ethane	Silicone	25	77	1875	I
Ethylene	Silicone	Room		1013	I
Formaldehyde	Silicone	Room		8830	I
Freon 11	Silicone	25	77	11250	I

(1) Std cc cm/cm2 sec. bar

(2) "I" denotes information from "Permeability Data for Aerospace Applications" funded by NASA and prepared by IIT Research Institute, March 1968.

"A" denotes information from Atomics International Division, Energy Systems Group, Rockwell International publication AI-AEC-13145,

"Design Guide for Reactor Cover Gas Elastomer Seals" March 7, 1975, and addendum, report ESC-DOE-13245, September 30, 1978.

"DC" denotes information from Dow Corning Bulletin 17-158, October 1972.

"P" denotes information from Parker Seal tests.

(3) "NR" Temperature not reported.

(4) Registered trademark E.I. du Pont de Nemours & Co.

Note: Some of these compounds may no longer be available.

Table 3-24: Gas Permeability Rates

WARNING: These products can expose you to chemicals including carbon black (airborne and extracts), antimony trioxide, titanium dioxide, silica (crystalline), di(2-ethylhexyl) phthalate, ethylene thiourea, acrylonitrile, 1,3-butadiene, epichlorohydrin, toluenediisocyanate, tetrafluoroethylene, ethylbenzene, formaldehyde, furfuryl alcohol, glass fibers, methyl isobutyl ketone, nickel (metallic and compounds), lead and lead compounds which are known to the State of California to cause cancer; and 1,3-butadiene, epichlorohydrin, di(2-ethylhexyl)phthalate, di-isodecyl phthalate, ethylene thiourea, methyl isobutyl ketone, methanol, toluene, lead and lead compounds which are known to the State of California to cause birth defects and other reproductive harm. For more information go to www.P65Warnings.ca.gov.

Gas Permeability Rates

Gas or Liquid	Elastomer	Temperature		Permeability ⁽¹⁾ x 10 ⁻⁸	Source ⁽²⁾
		°C	°F		
Freon 12	Butyl	25	77	1.05 to 55.5	I
Freon 12	Fluorocarbon	25	77	2.4 to 63	I
Freon 12	Neoprene	25	77	8.78	I
Freon 12	Nitrile	25	77	.3 to 5.5	I
Freon 12	Polyurethane	25	77	14.55	I
Freon 12	Silicone	25	77	1035	I
Freon 22	Butyl	25	77	3.0	I
Freon 22	Fluorocarbon	25	77	57	I
Freon 22	Neoprene	25	77	19.5	I
Freon 22	Nitrile	25	77	353	I
Freon 22	Polyurethane	25	77	225	I
Helium	Butadiene	25	77	11.8	I
Helium	Butyl (B0612-70)	25	77	6.5	P
Helium	Butyl (B0612-70)	80	176	52.0	P
Helium	Butyl (B0612-70)	150	302	240	P
Helium	EP (E0515-80)	25	77	19.7	P
Helium	EP (E0515-80)	80	176	61.0	P
Helium	EP (E0515-80)	150	302	320	P
Helium	Fluorocarbon	30	86	12.8	I
Helium	Fluorocarbon (V0747-75)	25	77	12.7	P
Helium	Fluorocarbon (V0747-75)	80	176	131	P
Helium	Fluorocarbon (V0747-75)	150	302	490	P
Helium	Fluorosilicone (L0449-65)	25	77	143	P
Helium	Fluorosilicone (L0449-65)	80	176	461	P
Helium	Fluorosilicone (L0449-65)	150	302	973	P
Helium	Natural	25	77	17.25 to 32.3	I
Helium	Natural	30	86	27.0	I
Helium	Natural	34	93	43.0	I
Helium	Natural	50	122	51.6	I
Helium	Neoprene	0	32	1.7	I
Helium	Neoprene	25	77	.6 to 7.5	I
Helium	Neoprene (C0557-70)	25	77	6.5	P
Helium	Neoprene	30.4	87	5.9	I
Helium	Neoprene	41.5	107	11.8	I
Helium	Neoprene	57	135	26.3	I
Helium	Neoprene	73	163	36.0	I
Helium	Neoprene (C0557-70)	80	176	59.6	P
Helium	Neoprene	101.3	214	70.5	I
Helium	Neoprene (C0557-70)	150	302	187	P
Helium	Nitrile	25	77	7.40	I
Helium	Nitrile (N0674-70)	25	77	8.0	P
Helium	Nitrile	50	122	19.3	I
Helium	Nitrile (N0674-70)	80	176	65.9	P
Helium	Nitrile (N0674-70)	150	302	252	P
Helium	Nitroso	NR3		1050	I
Helium	Polyacrylate (A0607-70)	25	77	16.3	P
Helium	Polyacrylate (A0607-70)	80	176	110	P
Helium	Polyacrylate (A0607-70)	150	302	310	P
Helium	Polyurethane (P0642-70)	25	77	3.6	P
Helium	Polyurethane (P0642-70)	80	176	33.5	P
Helium	SBR	25	77	17.3	I
Helium	Silicone	25	77	263	I
Helium	Silicone (S0604-70)	25	77	238	P
Helium	Silicone	30	86	173	I

(1) Std cc cm/cm² sec. bar

(2) "I" denotes information from "Permeability Data for Aerospace Applications" funded by NASA and prepared by IIT Research Institute, March 1968.

"A" denotes information from Atomic International Division, Energy Systems Group, Rockwell International publication AI-AEC-13145,

"Design Guide for Reactor Cover Gas Elastomer Seals" March 7, 1975, and addendum, report ESC-DOE-13245, September 30, 1978.

"DC" denotes information from Dow Corning Bulletin 17-158, October 1972.

"P" denotes information from Parker Seal tests.

(3) "NR" Temperature not reported.

(4) Registered trademark E.I. du Pont de Nemours & Co.

Note: Some of these compounds may no longer be available.

Table 3-24: Gas Permeability Rates



WARNING: These products can expose you to chemicals including carbon black (airborne and extracts), antimony trioxide, titanium dioxide, silica (crystalline), di(2-ethylhexyl) phthalate, ethylene thiourea, acrylonitrile, 1,3-butadiene, epichlorohydrin, toluenediisocyanate, tetrafluoroethylene, ethylbenzene, formaldehyde, furfuryl alcohol, glass fibers, methyl isobutyl ketone, nickel (metallic and compounds), lead and lead compounds which are known to the State of California to cause cancer; and 1,3-butadiene, epichlorohydrin, di(2-ethylhexyl)phthalate, di-isodecyl phthalate, ethylene thiourea, methyl isobutyl ketone, methanol, toluene, lead and lead compounds which are known to the State of California to cause birth defects and other reproductive harm. For more information go to www.P65Warnings.ca.gov.

Gas Permeability Rates

Gas or Liquid	Elastomer	Temperature		Permeability ⁽¹⁾ x 10 ⁻⁸	Source ⁽²⁾
		°C	°F		
Helium	Silicone (S0604-70)	80	176	560	P
Helium	Silicone (S0604-70)	150	302	1250	P
Helium	TFE PTFE	25	77	523 (sic)	I
Helium	TFE PTFE	30	86	90.0	I
Helium	TFE PTFE	50	122	128	I
Helium	FEP PTFE	25	77	30.1	I
Helium	FEP PTFE	30	86	46.5	I
Helium	FEP PTFE	50	122	58.5	I
Helium	FEP PTFE	75	167	94.4	I
Helium	FEP PTFE	100	212	157	I
Hexane	Silicone	25	77	7050	I
Hydrogen	Butadiene	25	77	31.6	I
Hydrogen	Butadiene	50	122	76.0	I
Hydrogen	Butyl (B0318-70)	35	95	16.1	A
Hydrogen	Butyl (B0318-70)	82	180	68.2	A
Hydrogen	Butyl (B0318-70)	124	255	273	A
Hydrogen	Ethylene Propylene	38	100	28.9 to 111	A
Hydrogen	Ethylene Propylene (E0529-65)	40	104	111	A
Hydrogen	Ethylene Propylene (E0692-75)	38	100	45.3	A
Hydrogen	Ethylene Propylene	93	200	187 to 544	A
Hydrogen	Ethylene Propylene (E0529-65)	94	202	544	A
Hydrogen	Ethylene Propylene (E0692-75)	94	201	252	A
Hydrogen	Ethylene Propylene	152	306	599 to 1730	A
Hydrogen	Ethylene Propylene (E0529-65)	155	311	1730	A
Hydrogen	Ethylene Propylene (E0692-75)	151	304	591	A
Hydrogen	Fluorocarbon-Viton4	93	200	160	A
Hydrogen	Neoprene	38	100	180	A
Hydrogen	Nitrile	38	100	10.3 to 32.1	A
Hydrogen	Nitrile (N0741-75)	39	103	11.9	A
Hydrogen	Nitrile	79	175	47.0 to 125	A
Hydrogen	Nitrile (N0741-75)	80	176	88.2	A
Hydrogen	Nitrile	121	250	98.8 to 330	A
Hydrogen	Polyacrylate (A0607-70)	38	100	49.6	A
Hydrogen	Polyacrylate (A0607-70)	91	195	174	A
Hydrogen	Polyacrylate (A0607-70)	153	307	927	A
Hydrogen	Polysulfide	25	77	1.2	I
Hydrogen	Polyurethane (P0642-70)	39	103	19.3	A
Hydrogen	Polyurethane (P0648-90)	39	102	4.89	A
Hydrogen	Polyurethane (P0642-70)	66	151	70.4	A
Hydrogen	Polyurethane (P0648-90)	67	152	21.3	A
Hydrogen	Polyurethane (P0642-70)	94	202	155	A
Hydrogen	SBR	25	77	30.1	I
Hydrogen	SBR (G0244-70)	38	101	46.2	A
Hydrogen	SBR (G0244-70)	84	183	245	A
Hydrogen	SBR (G0244-70)	122	251	539	A
Hydrogen	Silicone	Room		188 to 488	I
Hydrogen	Silicone	25	77	495	I
Hydrogen	Silicone (S0684-70)	39	103	1010	A
Hydrogen	Silicone	93	200	1570 to 2070	A
Hydrogen	Silicone (S0684-70)	91	195	2070	A
Hydrogen	Silicone	149	300	3300 to 8760	A
Hydrogen	Silicone (S0684-70)	156	313	4300	A
Hydrogen	FEP PTFE	-74	-101	.0113	I
Hydrogen	FEP PTFE	-46	-51	.180	I

(1) Std cc cm/cm2 sec. bar

(2) "I" denotes information from "Permeability Data for Aerospace Applications" funded by NASA and prepared by IIT Research Institute, March 1968.

"A" denotes information from Atomic International Division, Energy Systems Group, Rockwell International publication AI-AEC-13145,

"Design Guide for Reactor Cover Gas Elastomer Seals" March 7, 1975, and addendum, report ESC-DOE-13245, September 30, 1978.

"DC" denotes information from Dow Corning Bulletin 17-158, October 1972.

"P" denotes information from Parker Seal tests.

(3) "NR" Temperature not reported.

(4) Registered trademark E.I. du Pont de Nemours & Co.

Note: Some of these compounds may no longer be available.

Table 3-24: Gas Permeability Rates

WARNING: These products can expose you to chemicals including carbon black (airborne and extracts), antimony trioxide, titanium dioxide, silica (crystalline), di(2-ethylhexyl) phthalate, ethylene thiourea, acrylonitrile, 1,3-butadiene, epichlorohydrin, toluenediisocyanate, tetrafluoroethylene, ethylbenzene, formaldehyde, furfuryl alcohol, glass fibers, methyl isobutyl ketone, nickel (metallic and compounds), lead and lead compounds which are known to the State of California to cause cancer; and 1,3-butadiene, epichlorohydrin, di(2-ethylhexyl)phthalate, di-isodecyl phthalate, ethylene thiourea, methyl isobutyl ketone, methanol, toluene, lead and lead compounds which are known to the State of California to cause birth defects and other reproductive harm. For more information go to www.P65Warnings.ca.gov.

Gas Permeability Rates

Gas or Liquid	Elastomer	Temperature		Permeability ⁽¹⁾ x 10 ⁻⁸	Source ⁽²⁾
		°C	°F		
Hydrogen	FEP PTFE	-18	0	1.05	I
Hydrogen	FEP PTFE	10	50	3.90	I
Hydrogen	FEP PTFE	25	77	9.89	I
Hydrogen	FEP PTFE	38	100	10.1	I
Hydrogen	FEP PTFE	50	122	24.7	I
Hydrogen	FEP PTFE	66	151	22.5	I
Hydrogen	FEP PTFE	75	167	49.5	I
Hydrogen	FEP PTFE	100	212	89.9	I
Hydrogen	TFE PTFE	25	77	17.8	I
Hydrogen	TFE PTFE	30	86	42.0	I
Hydrogen	TFE PTFE	50	122	63.8	I
Hydrogen Sulfide	Silicone	25	77	4870	I
Iodine	Silicone	Room		75000	I
Krypton	Butyl (B0318-70)	35	95	1.39	A
Krypton	Butyl (B0318-70)	82	180	10.3	A
Krypton	Butyl (B0318-70)	124	255	54.7	A
Krypton	Ethylene Propylene (E0529-65)	40	104	38.6	A
Krypton	Ethylene Propylene (E0692-75)	38	101	16.6	A
Krypton	Ethylene Propylene (E0529-65)	94	202	184	A
Krypton	Ethylene Propylene (E0692-75)	94	201	91.2	A
Krypton	Ethylene Propylene (E0529-65)	155	311	324	A
Krypton	Ethylene Propylene (E0692-75)	151	304	289	A
Krypton	Fluorocarbon-Viton ⁽⁴⁾	93	200	25	A
Krypton	Natural	35	95	47.8	I
Krypton	Neoprene	38	100	32	A
Krypton	Nitrile	38	100	.935 to 4.40	A
Krypton	Nitrile (N0741-75)	39	103	1.82	A
Krypton	Nitrile	79	175	10.7 to 30.1	A
Krypton	Nitrile (N0741-75)	80	176	11.6	A
Krypton	Nitrile	121	250	27.8 to 86.6	A
Krypton	Nitrile (N0741-75)	118	245	48.9	A
Krypton	Polyacrylate (A0607-70)	38	100	14.8	A
Krypton	Polyacrylate (A0607-70)	91	195	90.4	A
Krypton	Polyacrylate (A0607-70)	153	307	464	A
Krypton	Polyurethane (P0642-70)	39	103	2.06	A
Krypton	Polyurethane (P0648-90)	39	102	.783	A
Krypton	Polyurethane (P0642-70)	66	151	6.53	A
Krypton	Polyurethane (P0648-90)	67	152	4.35	A
Krypton	Polyurethane (P0642-70)	94	202	31.9	A
Krypton	Polyurethane (P0648-90)	94	201	36.8	A
Krypton	SBR	38	100	7.35 to 30.8	A
Krypton	SBR (G0244-70)	38	101	7.35	A
Krypton	SBR	82	180	43.0 to 82.1	A
Krypton	SBR (G0244-70)	84	183	43.0	A
Krypton	SBR	121	250	144 to 276	A
Krypton	SBR (G0244-70)	122	251	144	A
Krypton	Silicone	Room		735	I
Krypton	Silicone	38	100	521 to 708	A
Krypton	Silicone (S0684-70)	38	101	708	A
Krypton	Silicone	93	200	749	A
Krypton	Silicone (S0684-70)	91	195	1440	A
Krypton	Silicone	149	300	1030 to 3190	A
Krypton	Silicone (S0684-70)	156	313	2320	A
Krypton	PTFE	149	300	24	A

(1) Std cc cm/cm² sec. bar

(2) "I" denotes information from "Permeability Data for Aerospace Applications" funded by NASA and prepared by IIT Research Institute, March 1968.

"A" denotes information from Atomics International Division, Energy Systems Group, Rockwell International publication AI-AEC-13145,

"Design Guide for Reactor Cover Gas Elastomer Seals" March 7, 1975, and addendum, report ESC-DOE-13245, September 30, 1978.

"DC" denotes information from Dow Corning Bulletin 17-158, October 1972.

"P" denotes information from Parker Seal tests.

(3) "NR" Temperature not reported.

(4) Registered trademark E.I. du Pont de Nemours & Co.

Note: Some of these compounds may no longer be available.

Table 3-24: Gas Permeability Rates

WARNING: These products can expose you to chemicals including carbon black (airborne and extracts), antimony trioxide, titanium dioxide, silica (crystalline), di(2-ethylhexyl) phthalate, ethylene thiourea, acrylonitrile, 1,3-butadiene, epichlorohydrin, toluenediisocyanate, tetrafluoroethylene, ethylbenzene, formaldehyde, furfuryl alcohol, glass fibers, methyl isobutyl ketone, nickel (metallic and compounds), lead and lead compounds which are known to the State of California to cause cancer; and 1,3-butadiene, epichlorohydrin, di(2-ethylhexyl)phthalate, di-isodecyl phthalate, ethylene thiourea, methyl isobutyl ketone, methanol, toluene, lead and lead compounds which are known to the State of California to cause birth defects and other reproductive harm. For more information go to www.P65Warnings.ca.gov.

Gas Permeability Rates

Gas or Liquid	Elastomer	Temperature		Permeability ⁽¹⁾ x 10 ⁻⁸	Source ⁽²⁾
		°C	°F		
Methane	Butadiene	25	77	9.77	I
Methane	Butyl	25	77	.56	I
Methane	Fluorocarbon	30	86	.12	I
Methane	Natural	25	77	22.7	I
Methane	Neoprene	25	77	2.6	I
Methane	Nitrile	25	77	2.4	I
Methane	Silicone	25	77	705	I
Methane	Silicone	30	86	443	I
Methane	FEP PTFE	25	77	.702 to .83	I
Methane	FEP PTFE	30	86	1.05	I
Methane	FEP PTFE	50	122	2.02	I
Methane	FEP PTFE	75	167	4.50	I
Methane	FEP PTFE	100	212	8.99	I
Methane	TFE PTFE	30	86	1.13	I
Methane	TFE PTFE	50	122	3.0	I
Methanol	Silicone	Room		10430	I
Neon	Natural	35	95	8.5	I
Nitric Oxide	Silicone	Room		450	I
Nitrogen	Butadiene	25	77	3.0	I
Nitrogen	Butadiene	25	77	4.85	I
Nitrogen	Butadiene	50	122	14.3	I
Nitrogen	Butyl	25	77	.244	I
Nitrogen	Butyl	30	86	.234	I
Nitrogen	Butyl	50	122	1.25	I
Nitrogen	Fluorocarbon	30	86	.233	I
Nitrogen	Fluorocarbon	50	122	.975	I
Nitrogen	Fluorosilicone	Room		40	DC
Nitrogen	Isoprene	25	77	5.3	I
Nitrogen	Isoprene	50	122	16.8	I
Nitrogen	Natural	Room		4.8	DC
Nitrogen	Natural	25	77	6.04 to 9.9	I
Nitrogen	Natural	30	86	6.06 to 7.9	I
Nitrogen	Natural	50	122	19.1	I
Nitrogen	Neoprene	25	77	.01 to 2	I
Nitrogen	Neoprene	30	86	.885	I
Nitrogen	Neoprene	54	129	4.35	I
Nitrogen	Neoprene	85	185	16.7	I
Nitrogen	Nitrile	20	68	.46	I
Nitrogen	Nitrile	25	77	.177 to 1.89	I
Nitrogen	Nitrile	30	86	.176 to .795	I
Nitrogen	Nitrile	50	122	1.07 to 6.9	I
Nitrogen	Nitrile	79	174	13.4	I
Nitrogen	Nitroso	NR3		108	I
Nitrogen	SBR	25	77	4.7	I
Nitrogen	SBR	30	86	4.76	I
Nitrogen	Silicone	Room		75 to 120	I
Nitrogen	Silicone	Room		210	I
Nitrogen	Silicone	30	86	113 to 188	I
Nitrogen	Silicone	50	122	240	I
Nitrogen	TFE PTFE	25	77	2.4	I
Nitrogen	TFE PTFE	30	86	3.9	I
Nitrogen	TFE PTFE	50	122	7.5	I
Nitrogen	FEP PTFE	25	77	1.44	I
Nitrogen	FEP PTFE	30	86	1.9	I

(1) Std cc cm/cm² sec. bar

(2) "I" denotes information from "Permeability Data for Aerospace Applications" funded by NASA and prepared by IIT Research Institute, March 1968.

"A" denotes information from Atomics International Division, Energy Systems Group, Rockwell International publication AI-AEC-13145,

"Design Guide for Reactor Cover Gas Elastomer Seals" March 7, 1975, and addendum, report ESC-DOE-13245, September 30, 1978.

"DC" denotes information from Dow Corning Bulletin 17-158, October 1972.

"P" denotes information from Parker Seal tests.

(3) "NR" Temperature not reported.

(4) Registered trademark E.I. du Pont de Nemours & Co.

Note: Some of these compounds may no longer be available.

Table 3-24: Gas Permeability Rates

WARNING: These products can expose you to chemicals including carbon black (airborne and extracts), antimony trioxide, titanium dioxide, silica (crystalline), di(2-ethylhexyl) phthalate, ethylene thiourea, acrylonitrile, 1,3-butadiene, epichlorohydrin, toluenediisocyanate, tetrafluoroethylene, ethylbenzene, formaldehyde, furfuryl alcohol, glass fibers, methyl isobutyl ketone, nickel (metallic and compounds), lead and lead compounds which are known to the State of California to cause cancer; and 1,3-butadiene, epichlorohydrin, di(2-ethylhexyl)phthalate, di-isodecyl phthalate, ethylene thiourea, methyl isobutyl ketone, methanol, toluene, lead and lead compounds which are known to the State of California to cause birth defects and other reproductive harm. For more information go to www.P65Warnings.ca.gov.

Gas Permeability Rates

Gas or Liquid	Elastomer	Temperature		Permeability ⁽¹⁾ x 10 ⁻⁸	Source ⁽²⁾
		°C	°F		
Nitrogen	FEP PTFE	50	122	4.4	I
Nitrogen	FEP PTFE	75	167	9.2	I
Nitrogen	FEP PTFE	100	212	18.5	I
Nitrogen Dioxide	Silicone	Room		5701	I
Nitrogen Oxides	TFE PTFE	NR3		3475	I
Nitrogen Oxides	FEP PTFE	NR3		485	I
Nitrogen Tetroxide	TFE PTFE	25	77	0.050 to 1.00	I
Nitrogen Tetroxide	TFE PTFE	28	82	12.4	I
Nitrogen Tetroxide	TFE PTFE	28	82	3.9	I
Nitrous Oxide	Silicone	Room		3263	I
Octane	Silicone	25	77	6450	I
Oxygen	Butadiene	25	77	8.5	I
Oxygen	Butadiene	25	77	14.3	I
Oxygen	Butadiene	30	86	14.3	I
Oxygen	Butadiene	50	122	35.5	I
Oxygen	Butyl	Room		.98 to 1.05	I
Oxygen	Butyl	25	77	.89 to 4.2	I
Oxygen	Butyl	30	86	.86	I
Oxygen	Butyl	50	122	3.98	I
Oxygen	Fluorocarbon	26	79	1.7	I
Oxygen	Fluorosilicone	Room		81.3	DC
Oxygen	Fluorosilicone	Room		82.5	I
Oxygen	Fluorosilicone	26	79	78	I
Oxygen	Natural	Room		13.0	DC
Oxygen	Natural	25	77	17.5	I
Oxygen	Natural	30	86	17.48	I
Oxygen	Natural	50	122	46.4	I
Oxygen	Neoprene	23	73	3.1	I
Oxygen	Neoprene	25	77	3.0	I
Oxygen	Neoprene	25	77	1.13	I
Oxygen	Neoprene	38	100	13	A
Oxygen	Neoprene	50	122	4.73	I
Oxygen	Nitrile	25	77	.72 to 6.15	I
Oxygen	Nitrile	30	86	.72	I
Oxygen	Nitrile	50	122	3.45 to 18.9	I
Oxygen	Nitrile	20-30	68-86	.72 to 6.2	I
Oxygen	Polysulfide	23	73	5.78	I
Oxygen	Polysulfide	25	77	.22	I
Oxygen	Polyurethane	32	90	1.3 to 4.0	I
Oxygen	Polyurethane	Room		.80	DC
Oxygen	SBR	25	77	12.8	I
Oxygen	Silicone	Room		330 to 450	I
Oxygen	Silicone	21	70	195 to 443	I
Oxygen	Silicone	32	90	234	I
Oxygen	Silicone	34	93	346	I
Oxygen	Silicone	44	111	257 to 384	I
Oxygen	TFE PTFE	25	77	7.5	I
Oxygen	FEP PTFE	25	77	3.37	I
Oxygen	FEP PTFE	50	122	9.22	I
Oxygen	FEP PTFE	75	167	17.99	I
Oxygen	FEP PTFE	100	212	31.48	I
Pentane	Silicone	25	77	15000	I
Pentane	Silicone	30	86	32600	I
Pentane	Silicone	40	104	28900	I

(1) Std cc cm/cm2 sec. bar

(2) "I" denotes information from "Permeability Data for Aerospace Applications" funded by NASA and prepared by IIT Research Institute, March 1968.

"A" denotes information from Atomics International Division, Energy Systems Group, Rockwell International publication AI-AEC-13145,

"Design Guide for Reactor Cover Gas Elastomer Seals" March 7, 1975, and addendum, report ESC-DOE-13245, September 30, 1978.

"DC" denotes information from Dow Corning Bulletin 17-158, October 1972.

"P" denotes information from Parker Seal tests.

(3) "NR" Temperature not reported.

(4) Registered trademark E.I. du Pont de Nemours & Co.

Note: Some of these compounds may no longer be available.

Table 3-24: Gas Permeability Rates

WARNING: These products can expose you to chemicals including carbon black (airborne and extracts), antimony trioxide, titanium dioxide, silica (crystalline), di(2-ethylhexyl) phthalate, ethylene thiourea, acrylonitrile, 1,3-butadiene, epichlorohydrin, toluenediisocyanate, tetrafluoroethylene, ethylbenzene, formaldehyde, furfuryl alcohol, glass fibers, methyl isobutyl ketone, nickel (metallic and compounds), lead and lead compounds which are known to the State of California to cause cancer; and 1,3-butadiene, epichlorohydrin, di(2-ethylhexyl)phthalate, di-isodecyl phthalate, ethylene thiourea, methyl isobutyl ketone, methanol, toluene, lead and lead compounds which are known to the State of California to cause birth defects and other reproductive harm. For more information go to www.P65Warnings.ca.gov.

Gas Permeability Rates

Gas or Liquid	Elastomer	Temperature		Permeability ⁽¹⁾ x 10 ⁻⁸	Source ⁽²⁾
		°C	°F		
Pentane	Silicone	50	122	25700	I
Pentane	Silicone	60	140	22900	I
Pentane	Silicone	70	158	20700	I
Phenol	Silicone	25	77	8100	I
Propane	Butadiene	25	77	22 to 40.5	I
Propane	Butyl	25	77	1.28	I
Propane	Natural	25	77	126	I
Propane	Neoprene	25	77	5.4	I
Propane	Polysulfide	25	77	1.09	I
Propane	Silicone	25	77	3080	I
Pyridene	Silicone	25	77	1580	I
Sulfur Dioxide	Silicone	Room		11250	I
Toluene	Silicone	25	77	6850	I
Water Vapor	Ethylene Propylene	Room		550 to 3700	A
Water Vapor	Ethylene Propylene (E0692-75)	Room		550	A
Xenon	Butyl	25	77	.83 to 3.0	I
Xenon	Butyl (B0318-70)	35	95	.70	A
Xenon	Butyl (B0318-70)	82	180	6.73	A
Xenon	Butyl (B0318-70)	124	255	38.1	A
Xenon	Ethylene Propylene	38	100	12.2 to 44.5	A
Xenon	Ethylene Propylene (E0529-65)	40	104	44.5	A
Xenon	Ethylene Propylene (E0692-75)	38	100	37.8	A
Xenon	Ethylene Propylene (E0692-75)	93	200	112 to 214	A
Xenon	Ethylene Propylene (E0529-65)	94	202	195	A
Xenon	Ethylene Propylene (E0692-75)	94	201	167	A
Xenon	Ethylene Propylene	149	300	260 to 520	A
Xenon	Ethylene Propylene (E0529-65)	155	311	520	A
Xenon	Ethylene Propylene (E0692-75)	151	304	460	A
Xenon	Fluorocarbon	93	200	10	A
Xenon	Natural	25	77	17.3 to 32.2	I
Xenon	Natural	35	95	72.5	I
Xenon	Neoprene	25	77	3.4 to 7.5	I
Xenon	Neoprene	38	100	40	A
Xenon	Nitrile	25	77	.60 to 2.85	I
Xenon	Nitrile	38	100	.94	A
Xenon	Nitrile (N0741-75)	38	101	3.31	A
Xenon	Nitrile	79	175	7.83 to 36.8	A
Xenon	Nitrile (N0741-75)	81	178	13.2	A
Xenon	Nitrile	121	250	38.5 to 101	A
Xenon	Polyacrylate (A0607-70)	38	100	10.9	A
Xenon	Polyacrylate (A0607-70)	91	195	108	A
Xenon	Polyacrylate (A0607-70)	153	307	549	A
Xenon	Polyurethane (P0642-70)	39	103	2.57	A
Xenon	Polyurethane (P0648-90)	39	102	1.03	A
Xenon	Polyurethane (P0642-70)	66	151	9.58	A
Xenon	Polyurethane (P0648-90)	67	152	6.58	A
Xenon	Polyurethane (P0642-70)	94	202	43.0	A
Xenon	Polyurethane (P0648-90)	94	201	24.5	A
Xenon	SBR (G0244-70)	38	101	14.9	A
Xenon	SBR (G0244-70)	84	183	66.2	A
Xenon	SBR (G0244-70)	122	251	173	A
Xenon	Silicone	Room		1523	I
Xenon	Silicone	38	100	109 to 1220	A
Xenon	Silicone (S0684-70)	38	101	1220	A

(1) Std cc cm/cm2 sec. bar

(2) "I" denotes information from "Permeability Data for Aerospace Applications" funded by NASA and prepared by IIT Research Institute, March 1968.

"A" denotes information from Atomic International Division, Energy Systems Group, Rockwell International publication AI-AEC-13145,

"Design Guide for Reactor Cover Gas Elastomer Seals" March 7, 1975, and addendum, report ESC-DOE-13245, September 30, 1978.

"DC" denotes information from Dow Corning Bulletin 17-158, October 1972.

"P" denotes information from Parker Seal tests.

(3) "NR" Temperature not reported.

(4) Registered trademark E.I. du Pont de Nemours & Co.

Note: Some of these compounds may no longer be available.

Table 3-24: Gas Permeability Rates

WARNING: These products can expose you to chemicals including carbon black (airborne and extracts), antimony trioxide, titanium dioxide, silica (crystalline), di(2-ethylhexyl) phthalate, ethylene thiourea, acrylonitrile, 1,3-butadiene, epichlorohydrin, toluenediisocyanate, tetrafluoroethylene, ethylbenzene, formaldehyde, furfuryl alcohol, glass fibers, methyl isobutyl ketone, nickel (metallic and compounds), lead and lead compounds which are known to the State of California to cause cancer; and 1,3-butadiene, epichlorohydrin, di(2-ethylhexyl)phthalate, di-isodecyl phthalate, ethylene thiourea, methyl isobutyl ketone, methanol, toluene, lead and lead compounds which are known to the State of California to cause birth defects and other reproductive harm. For more information go to www.P65Warnings.ca.gov.

Gas Permeability Rates

Gas or Liquid	Elastomer	Temperature		Permeability ⁽¹⁾ x 10 ⁻⁸	Source ⁽²⁾
		°C	°F		
Xenon	Silicone	93	200	1290 to 2180	A
Xenon	Silicone (S0684-70)	91	195	2180	A
Xenon	Silicone (S0684-70)	148	299	700	A
Xenon	Silicone	149	300	1110 (sic) to 2200	A
Xenon	Silicone (S0684-70)	144	291	2200	A
Xenon	PTFE	149	300	5.3	A

(1) Std cc cm/cm² sec. bar

(2) "I" denotes information from "Permeability Data for Aerospace Applications" funded by NASA and prepared by IIT Research Institute, March 1968.

"A" denotes information from Atomics International Division, Energy Systems Group, Rockwell International publication AI-AEC-13145,

"Design Guide for Reactor Cover Gas Elastomer Seals" March 7, 1975, and addendum, report ESC-DOE-13245, September 30, 1978.

"DC" denotes information from Dow Corning Bulletin 17-158, October 1972.

"P" denotes information from Parker Seal tests.

(3) "NR" Temperature not reported.

(4) Registered trademark E.I. du Pont de Nemours & Co.

Note: Some of these compounds may no longer be available.

Table 3-24: Gas Permeability Rates



WARNING: These products can expose you to chemicals including carbon black (airborne and extracts), antimony trioxide, titanium dioxide, silica (crystalline), di(2-ethylhexyl) phthalate, ethylene thiourea, acrylonitrile, 1,3-butadiene, epichlorohydrin, toluenediisocyanate, tetrafluoroethylene, ethylbenzene, formaldehyde, furfuryl alcohol, glass fibers, methyl isobutyl ketone, nickel (metallic and compounds), lead and lead compounds which are known to the State of California to cause cancer; and 1,3-butadiene, epichlorohydrin, di(2-ethylhexyl)phthalate, di-isodecyl phthalate, ethylene thiourea, methyl isobutyl ketone, methanol, toluene, lead and lead compounds which are known to the State of California to cause birth defects and other reproductive harm. For more information go to www.P65Warnings.ca.gov.

Section IV – Static O-Ring Sealing

4.0 Introduction	4-2	Face Seal Glands	
4.1 Surface Finishes for Static O-Ring Seals	4-2	Design Chart 4-3	4-18
4.2 Static Male and Female O-Ring Design	4-2	Dovetail Grooves	
4.3 Face Type O-Ring Seals	4-2	Design Chart 4-4	4-19
4.4 Dovetail and Half-Dovetail Grooves	4-3	Half Dovetail Grooves	
4.5 Boss Seals	4-3	Design Chart 4-5	4-20
4.6 Failures and Leakage	4-3	Static Crush Seal Grooves	
4.7 O-Ring Glands	4-3	Design Chart 4-6	4-21
4.7.1 O-Ring Glands for Aerospace		Tube Fitting Boss Seals — AS5202	
Hydraulic Packings and Gaskets	4-3	Design Table 4-3	4-22
Design Chart 4-1 A & B	4-4	Tube Fitting Boss Seals — AS4395	
Design Table 4-1	4-5	Design Table 4-4	4-23
4.7.2 O-Ring Glands for Industrial Static Seals		Design Table 4-5	4-24
Design Chart 4-2	4-9	Vacuum Seal Glands	
Design Table 4-2	4-10	Design Chart 4-7	4-25

WARNING: These products can expose you to chemicals including carbon black (airborne and extracts), antimony trioxide, titanium dioxide, silica (crystalline), di(2-ethylhexyl) phthalate, ethylene thiourea, acrylonitrile, 1,3-butadiene, epichlorohydrin, toluenediisocyanate, tetrafluoroethylene, ethylbenzene, formaldehyde, furfuryl alcohol, glass fibers, methyl isobutyl ketone, nickel (metallic and compounds), lead and lead compounds which are known to the State of California to cause cancer; and 1,3-butadiene, epichlorohydrin, di(2-ethylhexyl)phthalate, di-isodecyl phthalate, ethylene thiourea, methyl isobutyl ketone, methanol, toluene, lead and lead compounds which are known to the State of California to cause birth defects and other reproductive harm. For more information go to www.P65Warnings.ca.gov.

Static O-Ring Sealing

4.0 Introduction

It has been said that O-rings are “the finest static seals ever developed.” Perhaps the prime reason for this is because they are almost human proof. No adjustment or human factor comes into play when O-rings are assembled originally or used in repairs if the gland has been designed and machined properly. O-rings do not require high bolting forces (torque) to seal perfectly. O-rings are versatile and save space and weight. They seal over an exceptionally wide range of pressures, temperatures and tolerances. Once seated, they continue to seal even though some feel that they theoretically should not. In addition, they are economical and easy to use. Therefore, we agree that the O-ring is “the finest static seal ever developed.”

4.1 Surface Finish for Static O-Ring Seals

The design charts indicate a surface roughness value not to exceed 32 micro-inches (32 rms) on the sealing surfaces for static seals with a maximum of 16 rms recommended for face-type gas seals. These figures are good general guidelines, but they do not tell the whole story.

Equally important is the method used to produce the finish. If the surface is produced by turning the part on a lathe, or by some other method that produces scratches and ridges that follow the direction of the groove, a very rough surface will still seal effectively. Some methods such as end milling or routing, however, will produce scratches that cut across the O-ring. Even these may have a rather high roughness value if the profile across them shows rounded “valleys” that the rubber can readily flow into. Usually, these tool marks have sharp, deep, angular valleys that the O-ring material will not penetrate or fill completely. For this type of surface, the recommended roughness values should not be exceeded.

4.2 Static Male and Female O-Ring Seal Design

Design Chart 4-2 and its accompanying Design Table 4-2 give one set of dimensions for static O-ring seals when the configuration is similar to a piston or rod application with no motion involved. Aerospace Design Standard AS5857 is shown in Design Chart 4-1 and Design Table 4-1 for aerospace and military applications.

For applications requiring more than two or three percent stretch on the inside diameter of the O-rings, refer to Figure 3-3 to determine the effective “W” dimension for the stretched ring. The desired percent squeeze should be applied to this cross section diameter. In large male gland assemblies, it may be desirable to use an O-ring one size smaller than indicated in the design chart. The design stretch is so small in these large sizes, that the O-ring tends to sag out of the groove before it is assembled. Using the next smaller size simplifies assembly, but requires a reduced gland depth to attain the proper squeeze.

The need for back-up rings should be investigated for pressures exceeding 103.5 Bar (1500 psi) (for all seal types). If there is no extrusion gap, back-up rings are not required. Very high pressures can be sealed without back-up rings if metal-to-metal contact (practically zero clearance) of the gland parts can be maintained. Instances have been reported of sealing pressures of 13,600 Bar (200,000 psi) with a 70 Shore A durometer O-ring without back-up rings. Vibration or pressure fluctuation sometimes will produce “breathing” which requires back-up rings at average pressures below 103.5 Bar (1500 psi). When using silicone O-rings, the clearances given in the design charts and tables should be reduced 50%.

For examples of static seals, see Figure 4-1 (female gland) and Figure 4-2 (male gland).

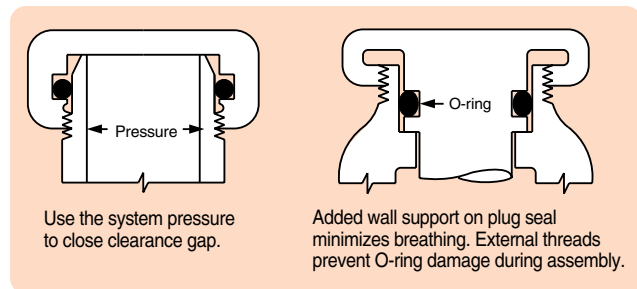

Figure 4-1: End Cap Seal

Figure 4-2: Plug Seal

4.3 Face Type Seals

Design Chart 4-3 explains how to design an O-ring seal when the groove is cut into a flat surface. Note that when the pressure is outward, the groove outside diameter (OD) is primary, and the groove width then determines the inside diameter. Conversely, when the pressure is inward, the groove inside diameter is primary. This design technique minimizes movement of the O-ring in the groove due to pressure, thereby virtually eliminating wear and pumping leakage. If this principle is used, groove diameters larger or smaller than indicated may be used.

Two possible groove widths are shown in this chart, one for liquids, and the other for vacuum and gases, the extra width for liquids allows for some minimal volume swell. In vacuum applications, the narrower width allows for faster pump down and reduces dead volume in which gas can be trapped. In sealing a liquid that is known to cause no swelling of the O-ring elastomer, the narrower groove would be suitable.

Design Chart 4-3 is preferred over Design Chart 4-2 for static face seals because it calls for a heavier squeeze in all but the smallest (.070) cross-section rings, thus improving reliability at low temperatures.

In a male or female gland design, the amount of squeeze required by Design Chart 4-3 is quite difficult to assemble.



WARNING: These products can expose you to chemicals including carbon black (airborne and extracts), antimony trioxide, titanium dioxide, silica (crystalline), di(2-ethylhexyl) phthalate, ethylene thiourea, acrylonitrile, 1,3-butadiene, epichlorohydrin, toluenediisocyanate, tetrafluoroethylene, ethylbenzene, formaldehyde, furfuryl alcohol, glass fibers, methyl isobutyl ketone, nickel (metallic and compounds), lead and lead compounds which are known to the State of California to cause cancer; and 1,3-butadiene, epichlorohydrin, di(2-ethylhexyl)phthalate, di-isodecyl phthalate, ethylene thiourea, methyl isobutyl ketone, methanol, toluene, lead and lead compounds which are known to the State of California to cause birth defects and other reproductive harm. For more information go to www.P65Warnings.ca.gov.

The 4-3 and 4-7 design charts are often used for vacuum seals. See O-Ring Applications, Section III, for assistance in finding the best rubber material and calculating the approximate leak rate for a face type static seal used for a vacuum or a gas.

Face type seals are sometimes rectangular. In designing such a seal to receive a standard O-ring, the inside corner radii of the groove should be at least three times (ideally six times) the cross-section diameter of the O-ring to avoid over-stressing the ring or causing corner creases that would potentially leak.

4.4 Dovetail and Half-Dovetail Grooves

It is sometimes necessary to mount an O-ring in a face type groove in such a way that it cannot fall out. The dovetail groove described in Design Charts 4-4 and 4-5 will serve this function. This groove is difficult and expensive to machine, and the tolerances are especially critical. It should be used only when it is absolutely necessary.

4.5 Boss Seals

The AS568-901 through -932 O-ring sizes (Parker's 3-series) are intended to be used for sealing straight thread tube fittings in a boss. Design Table 4-3 and Design Table 4-4 show the two standard boss designs that are used for this purpose.

Both of these bosses use the same O-ring, but Parker Seal Group recommends the Design Table 4-4 design when there is a choice. It is the newer design, and it has not been fully accepted yet by industry or by the military though there is a military standard for it. The 4-4 dimensions provide for closer tolerance control of the O-ring cavity and distort the O-ring less when assembled. The improved tolerance condition assures much less trouble due to leakage resulting from insufficient squeeze or extrusion when the older cavity is too small. The reduced distortion gives a longer life.

4.6 Failures and Leakage

By far the most common type of failure in static O-ring seals is extrusion. This is relatively easy to prevent if the curves of Figure 3-2 are used when the seal assembly (groove and seal element) is designed.

“Pulsing” or “pumping” leakage occasionally occurs when system pressure alone causes the O-ring to rotate in the groove and the resilience of the seal returns it to its original position. To avoid pumping leakage, design the gland so that the normal position of the seal cross-section will be on the low-pressure side of the gland or use a narrower groove.

Porous castings, eccentric grooves, out-of-tolerance parts, tool marks, and distorted or breathing glands are also frequent contributors to static O-ring seal malfunctioning and failure.

Cast housings and parts fabricated from powdered metal are commonly vacuum impregnated with an epoxy to seal minute pores. In this impregnation process, it is standard procedure to wash excess epoxy from the surface with acetone before

the parts are given an oven cure. This washing process may be overdone to the point where small fissures on the surface are re-opened causing leakage under the seal in spite of the epoxy impregnant. It is advisable, after the acetone bath, to paint the sealing surface with a thin film of epoxy and wipe off the excess before oven curing.

Leakage due to breathing, distortion, and incorrect machining requires a careful analysis of the problem and a consideration of the possible alternatives to find the most economical solution. When one of these causes is suspected, however, the possibility of porous metal should also be considered.

For additional information on O-ring failures, see Section VIII, Failure Analysis, in this handbook.

4.7 O-Ring Glands

4.7.1 O-Ring Glands (Per SAE AS5857) for Aerospace Hydraulic (Static and Reciprocating) Packings and Gaskets

The SAE Aerospace Standard (AS) 5857 provides standardized gland (groove) design criteria and dimensions for elastomeric seal glands for static applications. The glands have been specifically designed for applications using SAE AS568 size O-rings at pressures exceeding 1500 psi (10.3 MPa) utilizing one or two anti-extrusion (backup) rings and applications at pressures under 1500 psi (10.3 MPa) without backup rings. The glands have been sized to provide increased squeeze as compared to AS4716 (shown in Section V) for more effective sealing at low temperatures and low seal swell conditions. These glands are not recommended for dynamic use. Primary usage is for static external sealing.

The rod dimensions are the same as AS4716. The cylinder bore dimensions are the same as AS4716 except for sizes -001 through -011 and -104 through -113.

For additional information on SAE AS4716, see Section V, O-Ring Glands (Per AS4716) For Aerospace Hydraulic (Reciprocating) Packings And Gaskets.

4.7.2 O-Ring Glands for Industrial Static Seals

Design Chart 4-2 provides the basis for calculating gland dimensions. For standard O-ring sizes, these dimensions have been calculated and are listed in Design Table 4-2. The procedures for the use of Design Table 4-2 are outlined in the guide below.

After selecting gland dimensions, read horizontally to determine proper O-ring size number. Refer to Basic O-ring Elastomers and O-Ring Applications, Sections II and III respectively, for help in the selection of the proper compound. Remember, the effective part number for an O-ring consists of both a size number and a compound number.

Refer to Appendix, Section X for installation information.

WARNING: These products can expose you to chemicals including carbon black (airborne and extracts), antimony trioxide, titanium dioxide, silica (crystalline), di(2-ethylhexyl) phthalate, ethylene thiourea, acrylonitrile, 1,3-butadiene, epichlorohydrin, toluenediisocyanate, tetrafluoroethylene, ethylbenzene, formaldehyde, furfuryl alcohol, glass fibers, methyl isobutyl ketone, nickel (metallic and compounds), lead and lead compounds which are known to the State of California to cause cancer; and 1,3-butadiene, epichlorohydrin, di(2-ethylhexyl)phthalate, di-isodecyl phthalate, ethylene thiourea, methyl isobutyl ketone, methanol, toluene, lead and lead compounds which are known to the State of California to cause birth defects and other reproductive harm. For more information go to www.P65Warnings.ca.gov.

Gland Design, O-Ring and Other Elastomeric Seals (SAE AS5857)

Standard Gland Width for Zero, One, and Two Backup Rings in Inches

Gland and AS568 Dash Number	O-Ring Cross Section W		Backup Ring Width Max.	Gland Width G No Backup Ring		Gland Width G One Backup Ring		Gland Width G Two Backup Rings	
	Min.	Max.		Min.	Max.	Min.	Max.	Min.	Max.
001	.037	.043	--	.090	.095	--	--	--	--
002	.047	.053	--	.095	.100	--	--	--	--
003	.057	.063	--	.105	.110	--	--	--	--
004 to 007	.067	.073	.056	.115	.120	.174	.184	.230	.240
008 to 028	.067	.073	.056	.105	.110	.164	.174	.220	.230
104 to 109	.100	.106	.060	.150	.160	.210	.220	.275	.285
110 to 149	.100	.106	.060	.140	.150	.200	.210	.265	.275
210 to 247	.135	.143	.065	.185	.195	.250	.260	.320	.330
325 to 349	.205	.215	.090	.270	.280	.360	.370	.455	.465
425 to 460	.269	.281	.130	.345	.355	.475	.485	.610	.620

Design Chart 4-1 A: Gland Design, O-Ring and other Elastomeric Seals (SAE AS5857)

Gland Design, O-Ring and Other Elastomeric Seals (SAE AS5857)

Standard Gland Diametral Clearance Dimensions in Inches

Gland and AS568 Dash Number	O-Ring Cross-Section W		Diametral Clearance D Max.	
	Min.	Max.	Exterior	Interior
001	.037	.043	.004	.004
002	.047	.053	.004	.004
003	.057	.063	.004	.004
004 to 012	.067	.073	.004	.004
013 to 029	.067	.073	.005	.005
104 to 109	.100	.106	.004	.004
110 to 126	.100	.106	.004	.004
127 to 129	.100	.106	.005	.006
130 to 132	.100	.106	.006	.006
133 to 140	.100	.106	.006	.007
141 to 149	.100	.106	.007	.007
210 to 222	.135	.143	.005	.005
223 to 224	.135	.143	.006	.006
225 to 227	.135	.143	.006	.007
228 to 243	.135	.143	.007	.007
244 to 245	.135	.143	.008	.007
246 to 247	.135	.143	.008	.008
325 to 327	.205	.215	.006	.006
328 to 329	.205	.215	.006	.007
330 to 345	.205	.215	.007	.007
346 to 349	.205	.215	.008	.007
425 to 438	.269	.281	.009	.009
439 to 445	.269	.281	.009	.010
446	.269	.281	.010	.010
447 to 460	.269	.281	.011	.010

Design Chart 4-1 B: Gland Design, O-Ring and Other Elastomeric Seals (SAE AS5857)

WARNING: These products can expose you to chemicals including carbon black (airborne and extracts), antimony trioxide, titanium dioxide, silica (crystalline), di(2-ethylhexyl) phthalate, ethylene thiourea, acrylonitrile, 1,3-butadiene, epichlorohydrin, toluenediisocyanate, tetrafluoroethylene, ethylbenzene, formaldehyde, furfuryl alcohol, glass fibers, methyl isobutyl ketone, nickel (metallic and compounds), lead and lead compounds which are known to the State of California to cause cancer; and 1,3-butadiene, epichlorohydrin, di(2-ethylhexyl)phthalate, di-isodecyl phthalate, ethylene thiourea, methyl isobutyl ketone, methanol, toluene, lead and lead compounds which are known to the State of California to cause birth defects and other reproductive harm. For more information go to www.P65Warnings.ca.gov.

Gland Design, O-Rings and Other Elastomeric Seals (SAE AS5857)

Standard gland dimensions in inches.

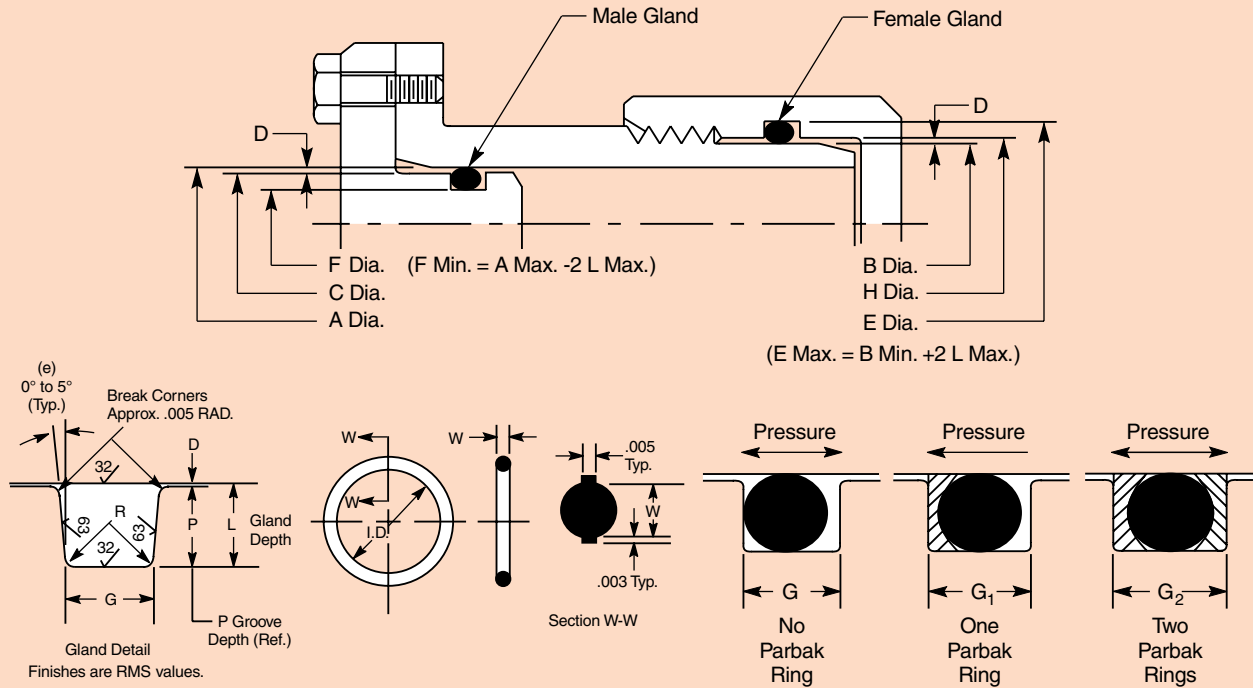

Gland Design, O-Ring and Other Elastomeric Seals (SAE AS5857)

Gland and AS568 Dash No.	Piston or Cylinder OD C	Cylinder Bore ID A	Gland OD F	Rod or Gland Sleeve OD B	Rod Bore ID H	Gland ID E
001	0.084	0.087	0.035	0.033	0.036	0.087
	0.083	0.086	0.034	0.032	0.035	0.086
002	0.116	0.119	0.048	0.048	0.051	0.119
	0.115	0.118	0.047	0.047	0.050	0.118
003	0.149	0.152	0.063	0.063	0.066	0.152
	0.148	0.151	0.062	0.062	0.065	0.151
004	0.183	0.186	0.078	0.076	0.079	0.185
	0.182	0.185	0.077	0.075	0.078	0.184
005	0.215	0.218	0.110	0.108	0.111	0.217
	0.214	0.217	0.109	0.107	0.110	0.216
006	0.228	0.231	0.123	0.123	0.126	0.232
	0.227	0.230	0.122	0.122	0.125	0.231
007	0.259	0.262	0.154	0.154	0.157	0.263
	0.258	0.261	0.153	0.153	0.156	0.262
008	0.291	0.294	0.186	0.185	0.188	0.294
	0.290	0.293	0.185	0.184	0.187	0.293
009	0.324	0.327	0.219	0.217	0.220	0.326
	0.323	0.326	0.218	0.216	0.219	0.325
010	0.355	0.358	0.250	0.248	0.251	0.357
	0.354	0.357	0.249	0.247	0.250	0.356
011	0.418	0.421	0.313	0.310	0.313	0.419
	0.417	0.420	0.312	0.309	0.312	0.418
012	0.483	0.486	0.378	0.373	0.376	0.482
	0.482	0.485	0.377	0.372	0.375	0.481
013	0.548	0.552	0.443	0.435	0.438	0.545
	0.547	0.550	0.441	0.433	0.437	0.543

Gland and AS568 Dash No.	Piston or Cylinder OD C	Cylinder Bore ID A	Gland OD F	Rod or Gland Sleeve OD B	Rod Bore ID H	Gland ID E
014	0.611	0.615	0.506	0.498	0.501	0.608
	0.610	0.613	0.504	0.496	0.500	0.606
015	0.673	0.677	0.568	0.560	0.563	0.670
	0.672	0.675	0.566	0.558	0.562	0.668
016	0.736	0.740	0.631	0.623	0.626	0.733
	0.735	0.738	0.629	0.621	0.625	0.731
017	0.798	0.802	0.693	0.685	0.688	0.795
	0.797	0.800	0.691	0.683	0.687	0.793
018	0.861	0.865	0.756	0.748	0.751	0.858
	0.860	0.863	0.754	0.746	0.750	0.856
019	0.923	0.927	0.818	0.810	0.813	0.920
	0.922	0.925	0.816	0.808	0.812	0.918
020	0.989	0.993	0.884	0.873	0.876	0.983
	0.988	0.991	0.882	0.871	0.875	0.981
021	1.051	1.055	0.946	0.935	0.938	1.045
	1.050	1.053	0.944	0.933	0.937	1.043
022	1.114	1.118	1.009	0.998	1.001	1.108
	1.113	1.116	1.007	0.996	1.000	1.106
023	1.176	1.180	1.071	1.060	1.063	1.170
	1.175	1.178	1.069	1.058	1.062	1.168
024	1.239	1.243	1.134	1.123	1.126	1.233
	1.238	1.241	1.132	1.121	1.125	1.231
025	1.301	1.305	1.196	1.185	1.188	1.295
	1.300	1.303	1.194	1.183	1.187	1.293
026	1.364	1.368	1.259	1.248	1.251	1.358
	1.363	1.366	1.257	1.246	1.250	1.356

Design Table 4-1: Gland Design, O-Ring and Other Elastomeric Seals (SAE AS5857)

WARNING: These products can expose you to chemicals including carbon black (airborne and extracts), antimony trioxide, titanium dioxide, silica (crystalline), di(2-ethylhexyl) phthalate, ethylene thiourea, acrylonitrile, 1,3-butadiene, epichlorohydrin, toluenediisocyanate, tetrafluoroethylene, ethylbenzene, formaldehyde, furfuryl alcohol, glass fibers, methyl isobutyl ketone, nickel (metallic and compounds), lead and lead compounds which are known to the State of California to cause cancer; and 1,3-butadiene, epichlorohydrin, di(2-ethylhexyl)phthalate, di-isodecyl phthalate, ethylene thiourea, methyl isobutyl ketone, methanol, toluene, lead and lead compounds which are known to the State of California to cause birth defects and other reproductive harm. For more information go to www.P65Warnings.ca.gov.

Gland Design, O-Ring and Other Elastomeric Seals (SAE AS5857) (Continued)

Gland and AS568 Dash No.	Piston or Cylinder OD C	Cylinder Bore ID A	Gland OD F	Rod or Gland Sleeve OD B	Rod Bore ID H	Gland ID E	Gland and AS568 Dash No.	Piston or Cylinder OD C	Cylinder Bore ID A	Gland OD F	Rod or Gland Sleeve OD B	Rod Bore ID H	Gland ID E
346	4.489	4.495	4.149	4.122	4.127	4.472	441	7.470	7.477	7.019	6.997	7.004	7.459
	4.487	4.493	4.147	4.120	4.125	4.470		7.468	7.474	7.016	6.994	7.001	7.456
347	4.614	4.620	4.274	4.247	4.252	4.597	442	7.720	7.727	7.269	7.247	7.254	7.709
	4.612	4.618	4.272	4.245	4.250	4.595		7.718	7.724	7.266	7.244	7.251	7.706
348	4.739	4.745	4.399	4.372	4.377	4.722	443	7.970	7.977	7.519	7.497	7.504	7.959
	4.737	4.743	4.397	4.370	4.375	4.720		7.968	7.974	7.516	7.494	7.501	7.956
349	4.864	4.870	4.524	4.497	4.502	4.847	444	8.220	8.227	7.769	7.747	7.754	8.209
	4.862	4.868	4.522	4.495	4.500	4.845		8.218	8.224	7.766	7.744	7.751	8.206
425	4.970	4.977	4.519	4.497	4.503	4.959	445	8.470	8.477	8.019	7.997	8.004	8.459
	4.968	4.974	4.516	4.494	4.501	4.956		8.468	8.474	8.016	7.994	8.001	8.456
426	5.095	5.102	4.644	4.622	4.628	5.084	446	8.970	8.977	8.519	8.497	8.504	8.959
	5.093	5.099	4.641	4.619	4.626	5.081		8.967	8.974	8.516	8.494	8.501	8.956
427	5.220	5.227	4.769	4.747	4.753	5.209	447	9.470	9.478	9.020	8.997	9.004	9.460
	5.218	5.224	4.766	4.744	4.751	5.206		9.467	9.474	9.017	8.994	9.001	9.456
428	5.345	5.352	4.894	4.872	4.878	5.334	448	9.970	9.978	9.520	9.497	9.504	9.960
	5.343	5.349	4.891	4.869	4.876	5.331		9.967	9.974	9.517	9.494	9.501	9.956
429	5.470	5.477	5.019	4.997	5.003	5.459	449	10.470	10.478	10.020	9.997	10.004	10.460
	5.468	5.474	5.016	4.994	5.001	5.456		10.467	10.474	10.017	9.994	10.001	10.456
430	5.595	5.602	5.144	5.122	5.128	5.584	450	10.970	10.978	10.520	10.497	10.504	10.960
	5.593	5.599	5.141	5.119	5.126	5.581		10.967	10.974	10.517	10.494	10.501	10.956
431	5.720	5.727	5.269	5.247	5.253	5.709	451	11.470	11.478	11.020	10.997	11.004	11.460
	5.718	5.724	5.266	5.244	5.251	5.706		11.467	11.474	11.017	10.994	11.001	11.456
432	5.845	5.852	5.394	5.372	5.378	5.834	452	11.970	11.978	11.520	11.497	11.504	11.960
	5.843	5.849	5.391	5.369	5.376	5.831		11.967	11.974	11.517	11.494	11.501	11.956
433	5.970	5.977	5.519	5.497	5.503	5.959	453	12.470	12.478	12.020	11.997	12.004	12.460
	5.968	5.974	5.516	5.494	5.501	5.956		12.467	12.474	12.017	11.994	12.001	12.456
434	6.095	6.102	5.644	5.622	5.628	6.084	454	12.970	12.978	12.520	12.497	12.504	12.960
	6.093	6.099	5.641	5.619	5.626	6.081		12.967	12.974	12.517	12.494	12.501	12.956
435	6.220	6.227	5.769	5.747	5.753	6.209	455	13.470	13.478	13.020	12.997	13.004	13.460
	6.218	6.224	5.766	5.744	5.751	6.206		13.467	13.474	13.017	12.994	13.001	13.456
436	6.345	6.352	5.894	5.872	5.878	6.334	456	13.970	13.978	13.520	13.497	13.504	13.960
	6.343	6.349	5.891	5.869	5.876	6.331		13.967	13.974	13.517	13.494	13.501	13.956
437	6.470	6.477	6.019	5.997	6.003	6.459	457	14.470	14.478	14.020	13.997	14.004	14.460
	6.468	6.474	6.016	5.994	6.001	6.456		14.467	14.474	14.017	13.994	14.001	14.456
438	6.720	6.727	6.269	6.247	6.253	6.709	458	14.970	14.978	14.520	14.497	14.504	14.960
	6.718	6.724	6.266	6.244	6.251	6.706		14.967	14.974	14.517	14.494	14.501	14.956
439	6.970	6.977	6.519	6.497	6.504	6.959	459	15.470	15.478	15.020	14.997	15.004	15.460
	6.968	6.974	6.516	6.494	6.501	6.956		15.467	15.474	15.017	14.994	15.001	15.456
440	7.220	7.227	6.769	6.747	6.754	7.209	460	15.970	15.978	15.520	15.497	15.504	15.960
	7.218	7.224	6.766	6.744	6.751	7.206		15.967	15.974	15.517	15.494	15.501	15.956

Design Table 4-1: Gland Design, O-Ring and Other Elastomeric Seals (SAE AS5857)

WARNING: These products can expose you to chemicals including carbon black (airborne and extracts), antimony trioxide, titanium dioxide, silica (crystalline), di(2-ethylhexyl) phthalate, ethylene thiourea, acrylonitrile, 1,3-butadiene, epichlorohydrin, toluenediisocyanate, tetrafluoroethylene, ethylbenzene, formaldehyde, furfuryl alcohol, glass fibers, methyl isobutyl ketone, nickel (metallic and compounds), lead and lead compounds which are known to the State of California to cause cancer; and 1,3-butadiene, epichlorohydrin, di(2-ethylhexyl)phthalate, di-isodecyl phthalate, ethylene thiourea, methyl isobutyl ketone, methanol, toluene, lead and lead compounds which are known to the State of California to cause birth defects and other reproductive harm. For more information go to www.P65Warnings.ca.gov.

Guide for Design Table 4-2

If Desired Dimension is Known for	Select Closest Dimension in Column	Read Horizontally in Column	To Determine Dimension for
Bore Dia. male gland	A	B-1 C G	Groove Dia. (male gland) Plug Dia. (male gland) Groove width
Plug Dia. male gland	C	A B-1 G	Bore Dia. (male gland) Groove (male gland) Groove width
Tube OD female gland	B	A-1 D G	Groove Dia. (female gland) Throat Dia. (female gland) Groove width
Throat Dia. female gland	D	A-1 B G	Groove Dia. (female gland) Tube OD (female gland) Groove width

Design Guide 4-2: Guide for Design Table 4-2

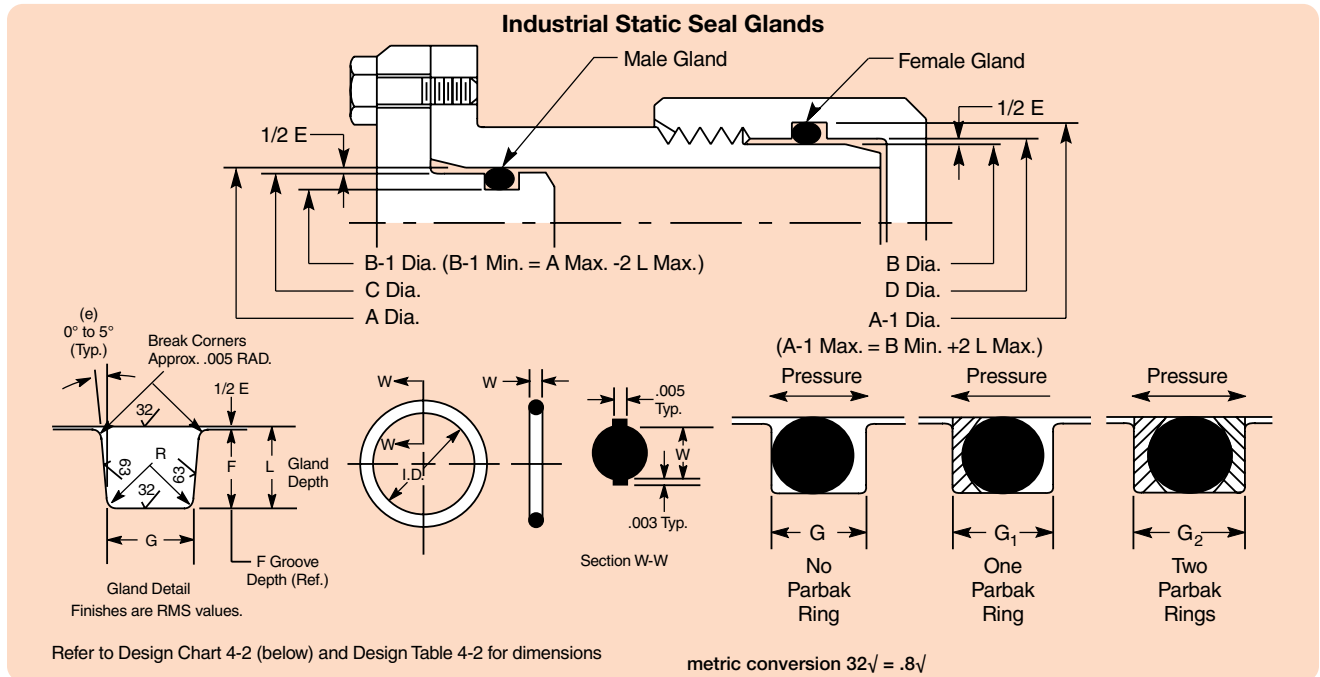

Industrial O-Ring Static Seal Glands

O-Ring 2-Size AS568B-	W Cross-Section		L Gland Depth	Squeeze %		E(a) Diametral Clearance	G - Groove Width			R Groove Radius	Max. Eccentricity (b)
	Nominal	Actual		Actual	%		No Parbak Ring (G)	One Parbak Ring (G ₁)	Two Parbak Ring (G ₂)		
004 through 050	1/16	.070 ±.003 (1.78 mm)	.050 to .052	.015 to .023	22 to 32	.002 to .005	.093 to .098	.138 to .143	.205 to .210	.005 to .015	.002
102 through 178	3/32	.103 ±.003 (2.62 mm)	.081 to .083	.017 to .025	17 to 24	.002 to .005	.140 to .145	.171 to .176	.238 to .243	.005 to .015	.002
201 through 284	1/8	.139 ±.004 (3.53 mm)	.111 to .113	.022 to .032	16 to 23	.003 to .006	.187 to .192	.208 to .213	.275 to .280	.010 to .025	.003
309 through 395	3/16	.210 ±.005 (5.33 mm)	.170 to .173	.032 to .045	15 to 21	.003 to .006	.281 to .286	.311 to .316	.410 to .415	.020 to .035	.004
425 through 475	1/4	.275 ±.006 (6.99 mm)	.226 to .229	.040 to .055	15 to 20	.004 to .007	.375 to .380	.408 to .413	.538 to .543	.020 to .035	.005

- (a) Clearance (extrusion gap) must be held to a minimum consistent with design requirements for temperature range variation.
- (b) Total indicator reading between groove and adjacent bearing surface.
- (c) Reduce maximum diametral clearance 50% when using silicone or fluorosilicone O-rings.
- (d) For ease of assembly, when Parbaks are used, gland depth may be increased up to 5%.

Design Chart 4-2: For Industrial O-Ring Static Seal Glands

WARNING: These products can expose you to chemicals including carbon black (airborne and extracts), antimony trioxide, titanium dioxide, silica (crystalline), di(2-ethylhexyl) phthalate, ethylene thiourea, acrylonitrile, 1,3-butadiene, epichlorohydrin, toluenediisocyanate, tetrafluoroethylene, ethylbenzene, formaldehyde, furfuryl alcohol, glass fibers, methyl isobutyl ketone, nickel (metallic and compounds), lead and lead compounds which are known to the State of California to cause cancer; and 1,3-butadiene, epichlorohydrin, di(2-ethylhexyl)phthalate, di-isodecyl phthalate, ethylene thiourea, methyl isobutyl ketone, methanol, toluene, lead and lead compounds which are known to the State of California to cause birth defects and other reproductive harm. For more information go to www.P65Warnings.ca.gov.

Gland Dimensions for Industrial O-Ring Static Seals, 103.5 Bar (1500 psi) Max.†

O-Ring Size Parker No. 2-	Dimensions				A	A-1	B	B-1	C	D	G†			
	ID	±	W	Mean OD (Ref)	Bore Dia. (Male Gland) +.002 -.000	Groove Dia. (Female Gland) -.000	Tube OD (Female Gland) +.000 -.002	Groove Dia. (Male Gland) +.000	Plug Dia. (Male Gland) +.000 .001	Throat Dia. (Female Gland) +.001 -.000	Groove Width +.005 -.000			
2-001	.029	.004	.040	.109	.105	.101	↑	.040	.044	↑	*	.103	.042	.055
002	.042	.004	.050	.142	.138	.132	.002	.053	.059	.002	*	.136	.055	.070
003	.056	.004	.060	.176	.172	.162	↓	.067	.077	↓	*	.170	.069	.083
004	.070	.005	↑	.210	.206	.181	↑	.081	.106	↑	*	.204	.083	↑
005	.101	.005	↑	.241	.237	.212	↑	.112	.137	↑	*	.235	.114	↑
006	.114	.005	↑	.254	.250	.225	↑	.125	.150	↑	*	.248	.127	↑
007	.145	.005	↑	.285	.281	.256	↑	.156	.181	↑	*	.279	.158	↑
008	.176	.005	↑	.316	.312	.287	↑	.187	.212	↑	*	.310	.189	↑
009	.208	.005	↑	.348	.343	.318	↑	.218	.243	↑	*	.341	.220	↑
010	.239	.005	↑	.379	.375	.350	↑	.250	.275	↑	*	.373	.252	↑
011	.301	.005	↑	.441	.437	.412	↑	.312	.337	↑	*	.435	.314	↑
012	.364	.005	↑	.504	.500	.475	↑	.375	.400	↑	*	.498	.377	↑
013	.426	.005	↑	.566	.562	.537	↑	.437	.462	↑	*	.560	.439	↑
014	.489	.005	↑	.629	.625	.600	↑	.500	.525	↑	*	.623	.502	↑
015	.551	.007	↑	.691	.687	.662	↑	.562	.587	↑	*	.685	.564	↑
016	.614	.009	↑	.754	.750	.725	↑	.625	.650	↑	*	.748	.627	↑
017	.676	.009	↑	.816	.812	.787	↑	.687	.712	↑	*	.810	.689	↑
018	.739	.009	↑	.879	.875	.850	↑	.750	.775	↑	*	.873	.752	↑
019	.801	.009	↑	.941	.937	.912	↑	.812	.837	↑	*	.935	.814	↑
020	.864	.009	↑	1.004	1.000	.975	↑	.875	.900	↑	*	.998	.877	↑
021	.926	.009	↑	1.066	1.062	1.037	↑	.937	.962	↑	*	1.060	.939	.093
022	.989	.010	.070	1.129	1.125	1.100	.002	1.000	1.025	.002	*	1.123	1.002	↑
023	1.051	.010	±.003	1.191	1.187	1.162	↑	1.062	1.087	↑	*	1.185	1.064	↑
024	1.114	.010	↑	1.254	1.250	1.225	↑	1.125	1.150	↑	*	1.248	1.127	↑
025	1.176	.011	↑	1.316	1.312	1.287	↑	1.187	1.212	↑	*	1.310	1.189	↑
026	1.239	.011	↑	1.379	1.375	1.350	↑	1.250	1.275	↑	*	1.373	1.252	↑
027	1.301	.011	↑	1.441	1.437	1.412	↑	1.312	1.337	↑	*	1.435	1.314	↑
028	1.364	.013	↑	1.504	1.500	1.475	↑	1.375	1.400	↑	*	1.498	1.377	↑
029	1.489	.013	↑	1.629	1.625	1.600	↑	1.500	1.525	↑	*	1.623	1.502	↑
030	1.614	.013	↑	1.754	1.750	1.725	↑	1.625	1.650	↑	*	1.748	1.627	↑
031	1.739	.015	↑	1.879	1.875	1.850	↑	1.750	1.775	↑	*	1.873	1.752	↑
032	1.864	.015	↑	2.004	2.000	1.975	↑	1.875	1.900	↑	*	1.998	1.877	↑
033	1.989	.018	↑	2.129	2.125	2.100	↑	2.000	2.025	↑	*	2.123	2.002	↑
034	2.114	.018	↑	2.254	2.250	2.225	↑	2.125	2.150	↑	*	2.248	2.127	↑
035	2.239	.018	↑	2.379	2.375	2.350	↑	2.250	2.275	↑	*	2.373	2.252	↑
036	2.364	.018	↑	2.504	2.500	2.475	↑	2.375	2.400	↑	*	2.498	2.377	↑
037	2.489	.018	↑	2.629	2.625	2.600	↑	2.500	2.525	↑	*	2.623	2.502	↑
038	2.614	.020	↑	2.754	2.750	2.725	↑	2.625	2.650	↑	*	2.748	2.627	↑
039	2.739	.020	↑	2.879	2.875	2.850	↑	2.750	2.775	↑	*	2.873	2.752	↑
040	2.864	.020	↑	3.004	3.000	2.975	↑	2.875	2.900	↑	*	2.998	2.877	↑
041	2.989	.024	↑	3.129	3.125	3.100	↑	3.000	3.025	↑	*	3.123	3.002	↑
042	3.239	.024	↑	3.379	3.375	3.350	↑	3.250	3.275	↑	*	3.373	3.252	↑
043	3.489	.024	↓	3.629	3.625	3.600	↓	3.500	3.525	↓	*	3.623	3.502	↓

† This groove width does not permit the use of Parbak rings. For pressures above 103.5 Bar (1500 psi), consult Design Chart 4-2 for groove widths where back-up rings must be used.

* These designs require considerable installation stretch. If assembly breakage is incurred, use a compound having higher elongation or use a two-piece piston.

Design Table 4-2: Gland Dimensions for Industrial O-Ring Static Seals, 103.5 Bar (1500 psi) Max.

WARNING: These products can expose you to chemicals including carbon black (airborne and extracts), antimony trioxide, titanium dioxide, silica (crystalline), di(2-ethylhexyl) phthalate, ethylene thiourea, acrylonitrile, 1,3-butadiene, epichlorohydrin, toluenediisocyanate, tetrafluoroethylene, ethylbenzene, formaldehyde, furfuryl alcohol, glass fibers, methyl isobutyl ketone, nickel (metallic and compounds), lead and lead compounds which are known to the State of California to cause cancer; and 1,3-butadiene, epichlorohydrin, di(2-ethylhexyl)phthalate, di-isodecyl phthalate, ethylene thiourea, methyl isobutyl ketone, methanol, toluene, lead and lead compounds which are known to the State of California to cause birth defects and other reproductive harm. For more information go to www.P65Warnings.ca.gov.

Gland Dimensions for Industrial O-Ring Static Seals, 103.5 Bar (1500 psi) Max.† (Continued)

O-Ring Size Parker No. 2-	Dimensions				A	A-1		B	B-1		C	D	G†
	ID	±	W	Mean OD (Ref)	Bore Dia. (Male Gland) +.002 -.000	Groove Dia. (Female Gland) -.000		Tube OD (Female Gland) +.000 -.002	Groove Dia. (Male Gland) +.000		Plug Dia. (Male Gland) +.000 .001	Throat Dia. (Female Gland) +.001 -.000	Groove Width +.005 -.000
044	3.739	.027	↑	3.879	3.875	3.850		3.750	3.775	↑	3.873	3.752	↑
045	3.989	.027	.070	4.129	4.125	4.100	.002	4.000	4.025	.002	4.123	4.002	.093
046	4.239	.030	±.003	4.379	4.375	4.350		4.250	4.275		4.373	4.252	
047	4.489	.030		4.629	4.625	4.600		4.500	4.525		4.623	4.502	
048	4.739	.030		4.879	4.875	4.850		4.750	4.775		4.873	4.752	
049	4.989	.037		5.129	5.125	5.100		5.000	5.025		5.123	5.002	
050	5.239	.037	↓	5.379	5.375	5.350		5.250	5.275	↓	5.373	5.252	↓
102	.049	.005	↑	.255	.247	.224	↑	.062	.085	↑	* .245	.064	↑
103	.081	.005		.287	.278	.256		.094	.116		* .276	.095	
104	.112	.005		.318	.310	.287		.125	.148		* .308	.127	
105	.143	.005		.349	.342	.318		.156	.180		* .340	.158	
106	.174	.005		.380	.374	.349		.187	.212		* .372	.189	
107	.206	.005		.412	.405	.381		.219	.243		* .403	.221	
108	.237	.005		.443	.437	.412		.250	.275		* .435	.252	
109	.299	.005		.505	.500	.474		.312	.338		* .498	.314	
110	.362	.005		.568	.562	.537		.375	.400		* .560	.377	
111	.424	.005		.630	.625	.599		.437	.463		* .623	.439	
112	.487	.005		.693	.687	.662		.500	.525		* .685	.502	
113	.549	.007		.755	.750	.724		.562	.588		* .748	.564	
114	.612	.009		.818	.812	.787		.625	.650		.810	.627	
115	.674	.009		.880	.875	.849		.687	.713		.873	.689	
116	.737	.009		.943	.937	.912		.750	.775		.935	.752	
117	.799	.010		1.005	1.000	.974		.812	.838		.998	.814	
118	.862	.010		1.068	1.062	1.037		.875	.900		1.060	.877	
119	.924	.010	.103	1.130	1.125	1.099	.002	.937	.963	.002	1.123	.939	.140
120	.987	.010	±.003	1.193	1.187	1.162		1.000	1.025		1.185	1.002	
121	1.049	.010		1.255	1.250	1.224		1.062	1.088		1.248	1.064	
122	1.112	.010		1.318	1.312	1.287		1.125	1.150		1.310	1.127	
123	1.174	.012		1.380	1.375	1.349		1.187	1.213		1.373	1.189	
124	1.237	.012		1.443	1.437	1.412		1.250	1.275		1.435	1.252	
125	1.299	.012		1.505	1.500	1.474		1.312	1.338		1.498	1.314	
126	1.362	.012		1.568	1.562	1.537		1.375	1.400		1.560	1.377	
127	1.424	.012		1.630	1.625	1.599		1.437	1.463		1.623	1.439	
128	1.487	.012		1.693	1.687	1.662		1.500	1.525		1.685	1.502	
129	1.549	.015		1.755	1.750	1.724		1.562	1.588		1.748	1.564	
130	1.612	.015		1.818	1.812	1.787		1.625	1.650		1.810	1.627	
131	1.674	.015		1.880	1.875	1.849		1.687	1.713		1.873	1.689	
132	1.737	.015		1.943	1.937	1.912		1.750	1.775		1.935	1.752	
133	1.799	.015		2.005	2.000	1.974		1.812	1.838		1.998	1.814	
134	1.862	.015		2.068	2.062	2.037		1.875	1.900		2.060	1.877	
135	1.925	.017		2.131	2.125	2.099		1.937	1.963		2.123	1.939	
136	1.987	.017		2.193	2.187	2.162		2.000	2.025		2.185	2.002	
137	2.050	.017	↓	2.256	2.250	2.224	↓	2.062	2.088	↓	2.248	2.064	↓

† This groove width does not permit the use of Parbak rings. For pressures above 103.5 Bar (1500 psi), consult Design Chart 4-2 for groove widths where back-up rings must be used.

* These designs require considerable installation stretch. If assembly breakage is incurred, use a compound having higher elongation or use a two-piece piston.

Design Table 4-2: Gland Dimensions for Industrial O-Ring Static Seals, 103.5 Bar (1500 psi) Max.

⚠ WARNING: These products can expose you to chemicals including carbon black (airborne and extracts), antimony trioxide, titanium dioxide, silica (crystalline), di(2-ethylhexyl) phthalate, ethylene thiourea, acrylonitrile, 1,3-butadiene, epichlorohydrin, toluenediisocyanate, tetrafluoroethylene, ethylbenzene, formaldehyde, furfuryl alcohol, glass fibers, methyl isobutyl ketone, nickel (metallic and compounds), lead and lead compounds which are known to the State of California to cause cancer; and 1,3-butadiene, epichlorohydrin, di(2-ethylhexyl)phthalate, di-isodecyl phthalate, ethylene thiourea, methyl isobutyl ketone, methanol, toluene, lead and lead compounds which are known to the State of California to cause birth defects and other reproductive harm. For more information go to www.P65Warnings.ca.gov.

Gland Dimensions for Industrial O-Ring Static Seals, 103.5 Bar (1500 psi) Max.† (Continued)

O-Ring Size Parker No. 2-	Dimensions				A	A-1	B	B-1	C	D	G†			
	ID	±	W	Mean OD (Ref)	Bore Dia. (Male Gland) +0.002 -0.000	Groove Dia. (Female Gland) -0.000	Tube OD (Female Gland) +0.000 -0.002	Groove Dia. (Male Gland) +0.000 -	Plug Dia. (Male Gland) +0.000 .001	Throat Dia. (Female Gland) +0.001 -0.001	Groove Width +0.005 -0.000			
138	2.112	.017	↑	2.318	2.312	2.287	↑	2.125	2.150	↑	2.310	2.127	↑	
139	2.175	.017		2.381	2.375	2.349		2.187	2.213		2.373	2.189		
140	2.237	.017		2.443	2.437	2.412		2.250	2.275		2.435	2.252		
141	2.300	.020		2.506	2.500	2.474		2.312	2.338		2.498	2.315		
142	2.362	.020		2.568	2.562	2.537		2.375	2.400		2.560	2.377		
143	2.425	.020		2.631	2.625	2.599		2.437	2.463		2.623	2.439		
144	2.487	.020		2.693	2.687	2.662		2.500	2.525		2.685	2.502		
145	2.550	.020		2.756	2.750	2.724		2.562	2.588		2.748	2.564		
146	2.612	.020		2.818	2.812	2.787		2.625	2.650		2.810	2.627		
147	2.675	.022		2.881	2.875	2.849		2.687	2.713		2.873	2.689		
148	2.737	.022		2.943	2.937	2.912		2.750	2.775		2.935	2.752		
149	2.800	.022		3.006	3.000	2.974		2.812	2.838		2.998	2.814		
150	2.862	.022		3.068	3.062	3.037		2.875	2.900		3.060	2.877		
151	2.987	.024		3.193	3.187	3.162		3.000	3.025		3.185	3.002		
152	3.237	.024		3.443	3.437	3.412		3.250	3.275		3.435	3.252		
153	3.487	.024		3.693	3.687	3.662		3.500	3.525		3.685	3.502		
154	3.737	.028	.103	3.943	3.937	3.912	.002	3.750	3.775	.002	3.935	3.752	.140	
155	3.987	.028	±.003	4.193	4.187	4.162		4.000	4.025		4.185	4.002		
156	4.237	.030		4.443	4.437	4.412		4.250	4.275		4.435	4.252		
157	4.487	.030		4.693	4.687	4.662		4.500	4.525		4.685	4.502		
158	4.737	.030		4.943	4.937	4.912		4.750	4.775		4.935	4.752		
159	4.987	.035		5.193	5.187	5.162		5.000	5.025		5.185	5.002		
160	5.237	.035		5.443	5.437	5.412		5.250	5.275		5.435	5.252		
161	5.487	.035		5.693	5.687	5.662		5.500	5.525		5.685	5.502		
162	5.737	.035		5.943	5.937	5.912		5.750	5.775		5.935	5.752		
163	5.987	.035		6.193	6.187	6.162		6.000	6.025		6.185	6.002		
164	6.237	.040		6.443	6.437	6.412		6.250	6.275		6.435	6.252		
165	6.487	.040		6.693	6.687	6.662		6.500	6.525		6.685	6.502		
166	6.737	.040		6.943	6.937	6.912		6.750	6.775		6.935	6.752		
167	6.987	.040		7.193	7.187	7.162		7.000	7.025		7.185	7.002		
168	7.237	.045		7.443	7.437	7.412		7.250	7.275		7.435	7.252		
169	7.487	.045		7.693	7.687	7.662		7.500	7.525		7.685	7.502		
170	7.737	.045		7.943	7.937	7.912		7.750	7.775		7.935	7.752		
171	7.987	.045		8.193	8.187	8.162		8.000	8.025		8.185	8.002		
172	8.237	.050		8.443	8.437	8.412		8.250	8.275		8.435	8.252		
173	8.487	.050		8.693	8.687	8.662		8.500	8.525		8.685	8.502		
174	8.737	.050		8.943	8.937	8.912		8.750	8.775		8.935	8.752		
175	8.987	.050		9.193	9.187	9.162		9.000	9.025		9.185	9.002		
176	9.237	.055		9.443	9.437	9.412		9.250	9.275		9.435	9.252		
177	9.487	.055		9.693	9.687	9.662		9.500	9.525		9.685	9.502		
178	9.737	.055		9.943	9.937	9.912		9.750	9.775		9.935	9.752		
201	.171	.005	.139	.449	.437	.409	↑	.187	.215	↑	*	.434	.190	↑
202	.234	.005	±.004	.512	.500	.472	.002	.250	.278	.002	*	.497	.253	.187
203	.296	.005		.574	.562	.534	↓	.312	.340	↓	*	.559	.315	↓

† This groove width does not permit the use of Parbak rings. For pressures above 103.5 Bar (1500 psi), consult Design Chart 4-2 for groove widths where back-up rings must be used.

* These designs require considerable installation stretch. If assembly breakage is incurred, use a compound having higher elongation or use a two-piece piston.

Design Table 4-2: Gland Dimensions for Industrial O-Ring Static Seals, 103.5 Bar (1500 psi) Max.

WARNING: These products can expose you to chemicals including carbon black (airborne and extracts), antimony trioxide, titanium dioxide, silica (crystalline), di(2-ethylhexyl) phthalate, ethylene thiourea, acrylonitrile, 1,3-butadiene, epichlorohydrin, toluenediisocyanate, tetrafluoroethylene, ethylbenzene, formaldehyde, furfuryl alcohol, glass fibers, methyl isobutyl ketone, nickel (metallic and compounds), lead and lead compounds which are known to the State of California to cause cancer; and 1,3-butadiene, epichlorohydrin, di(2-ethylhexyl)phthalate, di-isodecyl phthalate, ethylene thiourea, methyl isobutyl ketone, methanol, toluene, lead and lead compounds which are known to the State of California to cause birth defects and other reproductive harm. For more information go to www.P65Warnings.ca.gov.

Gland Dimensions for Industrial O-Ring Static Seals, 103.5 Bar (1500 psi) Max.† (Continued)

O-Ring Size Parker No. 2-	Dimensions				A	A-1		B	B-1		C	D	G†
	ID	±	W	Mean OD (Ref)	Bore Dia. (Male Gland) +.002 -.000	Groove Dia. (Female Gland) -.000	+	Tube OD (Female Gland) +.000 -.002	Groove Dia. (Male Gland) +.000	-	Plug Dia. (Male Gland) +.000 .001	Throat Dia. (Female Gland) +.001 -.000	Groove Width +.005 -.000
204	.359	.005	↑	.637	.625	.597	↑	.375	.403	↑	.622	.378	↑
205	.421	.005		.699	.687	.659		.437	.465		.684	.440	
206	.484	.005		.762	.750	.722		.500	.528		.747	.503	
207	.546	.007		.824	.812	.784		.562	.590		.809	.565	
208	.609	.009		.887	.875	.847		.625	.653		.872	.628	
209	.671	.009		.949	.937	.909		.687	.715		.934	.690	
210	.734	.010		1.012	1.000	.972		.750	.778		.997	.753	
211	.796	.010		1.074	1.062	1.034		.812	.840		1.059	.815	
212	.859	.010		1.137	1.125	1.097		.875	.903		1.122	.878	
213	.921	.010		1.199	1.187	1.159		.937	.965		1.184	.940	
214	.984	.010		1.262	1.250	1.222		1.000	1.028		1.247	1.003	
215	1.046	.010		1.324	1.312	1.284		1.062	1.090		1.309	1.065	
216	1.109	.012		1.387	1.375	1.347		1.125	1.153		1.372	1.128	
217	1.171	.012		1.449	1.437	1.409		1.187	1.215		1.434	1.190	
218	1.234	.012		1.512	1.500	1.472		1.250	1.278		1.497	1.253	
219	1.296	.012		1.574	1.562	1.534		1.312	1.340		1.559	1.315	
220	1.359	.012	.139	1.637	1.625	1.597	.002	1.375	1.403	.002	1.622	1.378	.187
221	1.421	.012	±.004	1.700	1.687	1.659		1.437	1.465		1.684	1.440	
222	1.484	.015		1.762	1.750	1.722		1.500	1.528		1.747	1.503	
223	1.609	.015		1.887	1.875	1.847		1.625	1.653		1.872	1.628	
224	1.734	.015		2.012	2.000	1.972		1.750	1.778		1.997	1.753	
225	1.859	.015		2.137	2.125	2.097		1.875	1.903		2.122	1.878	
226	1.984	.018		2.262	2.250	2.222		2.000	2.028		2.247	2.003	
227	2.109	.018		2.387	2.375	2.347		2.125	2.153		2.372	2.128	
228	2.234	.020		2.512	2.500	2.472		2.250	2.278		2.497	2.253	
229	2.359	.020		2.637	2.625	2.597		2.375	2.403		2.622	2.378	
230	2.484	.020		2.762	2.750	2.722		2.500	2.528		2.747	2.503	
231	2.609	.020		2.887	2.875	2.847		2.625	2.653		2.872	2.628	
232	2.734	.024		3.012	3.000	2.972		2.750	2.778		2.997	2.753	
233	2.859	.024		3.137	3.125	3.097		2.875	2.903		3.122	2.878	
234	2.984	.024		3.262	3.250	3.222		3.000	3.028		3.247	3.003	
235	3.109	.024		3.387	3.375	3.347		3.125	3.153		3.372	3.128	
236	3.234	.024		3.512	3.500	3.472		3.250	3.278		3.497	3.253	
237	3.359	.024		3.637	3.625	3.597		3.375	3.403		3.622	3.378	
238	3.484	.024		3.762	3.750	3.722		3.500	3.528		3.747	3.503	
239	3.609	.028		3.887	3.875	3.847		3.625	3.653		3.872	3.628	
240	3.734	.028		4.012	4.000	3.972		3.750	3.778		3.997	3.753	
241	3.859	.028		4.137	4.125	4.097		3.875	3.903		4.122	3.878	
242	3.984	.028		4.262	4.250	4.222		4.000	4.028		4.247	4.003	
243	4.109	.028		4.387	4.375	4.347		4.125	4.153		4.372	4.128	
244	4.234	.030		4.512	4.500	4.472		4.250	4.278		4.497	4.253	
245	4.359	.030		4.637	4.625	4.597		4.375	4.403		4.622	4.378	
246	4.484	.030		4.762	4.750	4.722		4.500	4.528		4.747	4.503	
247	4.609	.030	↓	4.887	4.875	4.847	↓	4.625	4.653	↓	4.872	4.628	↓

† This groove width does not permit the use of Parbak rings. For pressures above 103.5 Bar (1500 psi), consult Design Chart 4-2 for groove widths where back-up rings must be used.

* These designs require considerable installation stretch. If assembly breakage is incurred, use a compound having higher elongation or use a two-piece piston.

Design Table 4-2: Gland Dimensions for Industrial O-Ring Static Seals, 103.5 Bar (1500 psi) Max.

⚠ WARNING: These products can expose you to chemicals including carbon black (airborne and extracts), antimony trioxide, titanium dioxide, silica (crystalline), di(2-ethylhexyl) phthalate, ethylene thiourea, acrylonitrile, 1,3-butadiene, epichlorohydrin, toluenediisocyanate, tetrafluoroethylene, ethylbenzene, formaldehyde, furfuryl alcohol, glass fibers, methyl isobutyl ketone, nickel (metallic and compounds), lead and lead compounds which are known to the State of California to cause cancer; and 1,3-butadiene, epichlorohydrin, di(2-ethylhexyl)phthalate, di-isodecyl phthalate, ethylene thiourea, methyl isobutyl ketone, methanol, toluene, lead and lead compounds which are known to the State of California to cause birth defects and other reproductive harm. For more information go to www.P65Warnings.ca.gov.

Gland Dimensions for Industrial O-Ring Static Seals, 103.5 Bar (1500 psi) Max.† (Continued)

O-Ring Size Parker No. 2-	Dimensions				A	A-1		B	B-1		C	D	G†
	ID	±	W	Mean OD (Ref)	Bore Dia. (Male Gland) +.002 -.000	Groove Dia. (Female Gland) -.000	+	Tube OD (Female Gland) +.000 -.002	Groove Dia. (Male Gland) +.000	-	Plug Dia. (Male Gland) +.000 .001	Throat Dia. (Female Gland) +.001 -.000	Groove Width +.005 -.000
248	4.734	.030	↑	5.012	5.000	4.972	↑	4.750	4.778	↑	4.997	4.753	↑
249	4.859	.035		5.137	5.125	5.097		4.875	4.903		5.122	4.878	
250	4.984	.035		5.262	5.250	5.222		5.000	5.028		5.247	5.003	
251	5.109	.035		5.387	5.375	5.347		5.125	5.153		5.372	5.128	
252	5.234	.035		5.512	5.500	5.472		5.250	5.278		5.497	5.253	
253	5.359	.035		5.637	5.625	5.597		5.375	5.403		5.622	5.378	
254	5.484	.035		5.762	5.750	5.722		5.500	5.528		5.747	5.503	
255	5.609	.035		5.887	5.875	5.847		5.625	5.653		5.872	5.628	
256	5.734	.035		6.012	6.000	5.972		5.750	5.778		5.997	5.753	
257	5.859	.035		6.137	6.125	6.097		5.875	5.903		6.122	5.878	
258	5.984	.035		6.262	6.250	6.222		6.000	6.028		6.247	6.003	
259	6.234	.040		6.512	6.500	6.472		6.250	6.278		6.497	6.253	
260	6.484	.040		6.762	6.750	6.722		6.500	6.528		6.747	6.503	
261	6.734	.040		7.012	7.000	6.972		6.750	6.778		6.997	6.753	
262	6.984	.040		7.262	7.250	7.222		7.000	7.028		7.247	7.003	
263	7.234	.045		7.512	7.500	7.472		7.250	7.278		7.497	7.253	
264	7.484	.045		7.762	7.750	7.722		7.500	7.528		7.747	7.503	
265	7.734	.045	.139	8.012	8.000	7.972	.002	7.750	7.778	.002	7.997	7.753	.187
266	7.984	.045	±.004	8.262	8.250	8.222		8.000	8.028		8.247	8.003	
267	8.234	.050		8.512	8.500	8.472		8.250	8.278		8.497	8.253	
268	8.484	.050		8.762	8.750	8.722		8.500	8.528		8.747	8.503	
269	8.734	.050		9.012	9.000	8.972		8.750	8.778		8.997	8.753	
270	8.984	.050		9.262	9.250	9.222		9.000	9.028		9.247	9.003	
271	9.234	.055		9.512	9.500	9.472		9.250	9.278		9.497	9.253	
272	9.484	.055		9.762	9.750	9.722		9.500	9.528		9.747	9.503	
273	9.734	.055		10.012	10.000	9.972		9.750	9.778		9.997	9.753	
274	9.984	.055		10.262	10.250	10.222		10.000	10.028		10.247	10.003	
275	10.484	.055		10.762	10.750	10.722		10.500	10.528		10.747	10.503	
276	10.984	.065		11.262	11.250	11.222		11.000	11.028		11.247	11.003	
277	11.484	.065		11.762	11.750	11.722		11.500	11.528		11.747	11.503	
278	11.984	.065		12.262	12.250	12.222		12.000	12.028		12.247	12.003	
279	12.984	.065		13.262	13.250	13.222		13.000	13.028		13.247	13.003	
280	13.984	.065		14.262	14.250	14.222		14.000	14.028		14.247	14.003	
281	14.984	.065		15.262	15.250	15.222		15.000	15.028		15.247	15.003	
282	15.955	.075		16.233	16.250	16.222		16.000	16.028		16.247	16.003	
283	16.955	.080		17.233	17.250	17.222		17.000	17.028		17.247	17.003	
284	17.955	.085	↓	18.233	18.250	18.222	↓	18.000	18.028	↓	18.247	18.003	↓
309	.412	.005	↑	.832	.812	.777	↑	.437	.472	↑	* .809	.440	↑
310	.475	.005	.210	.895	.875	.840		.500	.535		* .872	.503	
311	.537	.007	±.005	.957	.937	.902	.004	.562	.597	.004	* .934	.565	.281
312	.600	.009		1.020	1.000	.965		.625	.660		.997	.628	
313	.662	.009		1.082	1.062	1.027		.687	.722		1.059	.690	
314	.725	.010	↓	1.145	1.125	1.090	↓	.750	.785	↓	1.122	.753	↓

† This groove width does not permit the use of Parbak rings. For pressures above 103.5 Bar (1500 psi), consult Design Chart 4-2 for groove widths where back-up rings must be used.

* These designs require considerable installation stretch. If assembly breakage is incurred, use a compound having higher elongation or use a two-piece piston.

Design Table 4-2: Gland Dimensions for Industrial O-Ring Static Seals, 103.5 Bar (1500 psi) Max.

WARNING: These products can expose you to chemicals including carbon black (airborne and extracts), antimony trioxide, titanium dioxide, silica (crystalline), di(2-ethylhexyl) phthalate, ethylene thiourea, acrylonitrile, 1,3-butadiene, epichlorohydrin, toluenediisocyanate, tetrafluoroethylene, ethylbenzene, formaldehyde, furfuryl alcohol, glass fibers, methyl isobutyl ketone, nickel (metallic and compounds), lead and lead compounds which are known to the State of California to cause cancer; and 1,3-butadiene, epichlorohydrin, di(2-ethylhexyl)phthalate, di-isodecyl phthalate, ethylene thiourea, methyl isobutyl ketone, methanol, toluene, lead and lead compounds which are known to the State of California to cause birth defects and other reproductive harm. For more information go to www.P65Warnings.ca.gov.

Gland Dimensions for Industrial O-Ring Static Seals, 103.5 Bar (1500 psi) Max.† (Continued)

O-Ring Size Parker No. 2-	Dimensions				A	A-1		B	B-1		C	D	G†
	ID	±	W	Mean OD (Ref)	Bore Dia. (Male Gland) +.002 -.000	Groove Dia. (Female Gland) -.000	+	Tube OD (Female Gland) +.000 -.002	Groove Dia. (Male Gland) +.000	-	Plug Dia. (Male Gland) +.000 .001	Throat Dia. (Female Gland) +.001 -.000	Groove Width +.005 -.000
315	.787	.010	↑	1.207	1.187	1.152	↑	.812	.847	↑	1.184	.815	↑
316	.850	.010		1.270	1.250	1.215		.875	.910		1.247	.878	
317	.912	.010		1.332	1.312	1.277		.937	.972		1.309	.940	
318	.975	.010		1.395	1.375	1.340		1.000	1.035		1.372	1.003	
319	1.037	.010		1.457	1.437	1.402		1.062	1.097		1.434	1.065	
320	1.100	.012		1.520	1.500	1.465		1.125	1.160		1.497	1.128	
321	1.162	.012		1.582	1.562	1.527		1.187	1.222		1.559	1.190	
322	1.225	.012		1.645	1.625	1.590		1.250	1.285		1.622	1.253	
323	1.287	.012		1.707	1.687	1.652		1.312	1.347		1.684	1.315	
324	1.350	.012		1.770	1.750	1.715		1.375	1.410		1.747	1.378	
325	1.475	.015		1.895	1.875	1.840		1.500	1.535		1.872	1.503	
326	1.600	.015		2.020	2.000	1.965		1.625	1.660		1.997	1.628	
327	1.725	.015		2.145	2.125	2.090		1.750	1.785		2.122	1.753	
328	1.850	.015		2.270	2.250	2.215		1.875	1.910		2.247	1.878	
329	1.975	.018		2.395	2.375	2.340		2.000	2.035		2.372	2.003	
330	2.100	.018		2.520	2.500	2.465		2.125	2.160		2.497	2.128	
331	2.225	.018		2.645	2.625	2.590		2.250	2.285		2.622	2.253	
332	2.350	.018		2.770	2.750	2.715		2.375	2.410		2.747	2.378	
333	2.475	.020		2.895	2.875	2.840		2.500	2.535		2.872	2.503	
334	2.600	.020		3.020	3.000	2.965		2.625	2.660		2.997	2.628	
335	2.725	.020		3.145	3.125	3.090		2.750	2.785		3.122	2.753	
336	2.850	.020	.210	3.270	3.250	3.215	.004	2.875	2.910	.004	3.247	2.878	.281
337	2.975	.024	±.005	3.395	3.375	3.340		3.000	3.035		3.372	3.003	
338	3.100	.024		3.520	3.500	3.465		3.125	3.160		3.497	3.128	
339	3.225	.024		3.645	3.625	3.590		3.250	3.285		3.622	3.253	
340	3.350	.024		3.770	3.750	3.715		3.375	3.410		3.747	3.378	
341	3.475	.024		3.895	3.875	3.840		3.500	3.535		3.872	3.502	
342	3.600	.028		4.020	4.000	3.965		3.625	3.660		3.997	3.628	
343	3.725	.028		4.145	4.125	4.090		3.750	3.785		4.122	3.753	
344	3.850	.028		4.270	4.250	4.215		3.875	3.910		4.247	3.878	
345	3.975	.028		4.395	4.375	4.340		4.000	4.035		4.372	4.003	
346	4.100	.028		4.520	4.500	4.465		4.125	4.160		4.497	4.128	
347	4.225	.030		4.645	4.625	4.590		4.250	4.285		4.622	4.253	
348	4.350	.030		4.770	4.750	4.717		4.375	4.410		4.747	4.378	
349	4.475	.030		4.895	4.875	4.840		4.500	4.535		4.872	4.503	
350	4.600	.030		5.020	5.000	4.965		4.625	4.660		4.997	4.628	
351	4.725	.030		5.145	5.125	5.090		4.750	4.785		5.122	4.753	
352	4.850	.030		5.270	5.250	5.215		4.875	4.910		5.247	4.878	
353	4.975	.037		5.395	5.375	5.340		5.000	5.035		5.372	5.003	
354	5.100	.037		5.520	5.500	5.465		5.125	5.160		5.497	5.128	
355	5.225	.037		5.645	5.625	5.590		5.250	5.285		5.622	5.253	
356	5.350	.037		5.770	5.750	5.715		5.375	5.410		5.747	5.378	
357	5.475	.037		5.895	5.875	5.840		5.500	5.535		5.872	5.503	
358	5.600	.037	↓	6.020	6.000	5.965	↓	5.625	5.660	↓	5.997	5.628	↓

† This groove width does not permit the use of Parbak rings. For pressures above 103.5 Bar (1500 psi), consult Design Chart 4-2 for groove widths where back-up rings must be used.

* These designs require considerable installation stretch. If assembly breakage is incurred, use a compound having higher elongation or use a two-piece piston.

Design Table 4-2: Gland Dimensions for Industrial O-Ring Static Seals, 103.5 Bar (1500 psi) Max.

⚠ WARNING: These products can expose you to chemicals including carbon black (airborne and extracts), antimony trioxide, titanium dioxide, silica (crystalline), di(2-ethylhexyl) phthalate, ethylene thiourea, acrylonitrile, 1,3-butadiene, epichlorohydrin, toluenediisocyanate, tetrafluoroethylene, ethylbenzene, formaldehyde, furfuryl alcohol, glass fibers, methyl isobutyl ketone, nickel (metallic and compounds), lead and lead compounds which are known to the State of California to cause cancer; and 1,3-butadiene, epichlorohydrin, di(2-ethylhexyl)phthalate, di-isodecyl phthalate, ethylene thiourea, methyl isobutyl ketone, methanol, toluene, lead and lead compounds which are known to the State of California to cause birth defects and other reproductive harm. For more information go to www.P65Warnings.ca.gov.

Gland Dimensions for Industrial O-Ring Static Seals, 103.5 Bar (1500 psi) Max.† (Continued)

O-Ring Size Parker No. 2-	Dimensions				A	A-1		B	B-1		C	D	G†
	ID	±	W	Mean OD (Ref)	Bore Dia. (Male Gland) +.002 -.000	Groove Dia. (Female Gland) -.000		Tube OD (Female Gland) +.000 -.002	Groove Dia. (Male Gland) +.000		Plug Dia. (Male Gland) +.000 .001	Throat Dia. (Female Gland) +.001 -.000	Groove Width +.005 -.000
359	5.725	.037	↑	6.145	6.125	6.090	↑	5.750	5.785	↑	6.122	5.753	↑
360	5.850	.037		6.270	6.250	6.215		5.875	5.910		6.247	5.878	
361	5.975	.037		6.395	6.375	6.340		6.000	6.035		6.372	6.003	
362	6.225	.040		6.645	6.625	6.590		6.250	6.285		6.622	6.253	
363	6.475	.040		6.895	6.875	6.840		6.500	6.535		6.872	6.503	
364	6.725	.040		7.145	7.125	7.090		6.750	6.785		7.122	6.753	
365	6.975	.040		7.395	7.375	7.340		7.000	7.035		7.372	7.003	
366	7.225	.045		7.645	7.625	7.590		7.250	7.285		7.622	7.253	
367	7.475	.045		7.895	7.875	7.840		7.500	7.535		7.872	7.503	
368	7.725	.045		8.145	8.125	8.090		7.750	7.785		8.122	7.753	
369	7.975	.045		8.395	8.375	8.340		8.000	8.035		8.372	8.003	
370	8.225	.050		8.645	8.625	8.590		8.250	8.285		8.622	8.253	
371	8.475	.050		8.895	8.875	8.840		8.500	8.535		8.872	8.503	
372	8.725	.050		9.145	9.125	9.090		8.750	8.785		9.122	8.753	
373	8.975	.050		9.395	9.375	9.340		9.000	9.035		9.372	9.003	
374	9.225	.055		9.645	9.625	9.590		9.250	9.285		9.622	9.253	
375	9.475	.055		9.895	9.875	9.840		9.500	9.535		9.872	9.503	
376	9.725	.055		10.145	10.125	10.090		9.750	9.785		10.122	9.753	
377	9.975	.055	.210	10.395	10.375	10.340	.004	10.000	10.035	.004	10.372	10.003	.281
378	10.475	.060	±.005	10.895	10.875	10.840		10.500	10.535		10.872	10.503	
379	10.975	.060		11.395	11.375	11.340		11.000	11.035		11.372	11.003	
380	11.475	.065		11.895	11.875	11.840		11.500	11.535		11.872	11.503	
381	11.975	.065		12.395	12.375	12.340		12.000	12.035		12.372	12.003	
382	12.975	.065		13.395	13.375	13.340		13.000	13.035		13.372	13.003	
383	13.975	.070		14.395	14.375	14.340		14.000	14.035		14.372	14.003	
384	14.975	.070		15.395	15.375	15.340		15.000	15.035		15.372	15.003	
385	15.955	.075		16.375	16.375	16.340		16.000	16.035		16.372	16.003	
386	16.955	.080		17.375	17.375	17.340		17.000	17.035		17.372	17.003	
387	17.955	.085		18.375	18.375	18.340		18.000	18.035		18.372	18.003	
388	18.955	.090		19.373	19.375	19.340		19.000	19.035		19.372	19.003	
389	19.955	.095		20.373	20.375	20.340		20.000	20.035		20.372	20.003	
390	20.955	.095		21.373	21.375	21.340		21.000	21.035		21.372	21.003	
391	21.955	.100		22.373	22.375	22.340		22.000	22.035		22.372	22.003	
392	22.940	.105		23.360	23.375	23.340		23.000	23.035		23.372	23.003	
393	23.940	.110		24.360	24.375	24.340		24.000	24.035		24.372	24.003	
394	24.940	.115		25.360	25.375	25.340		25.000	25.035		25.372	25.003	
395	25.940	.120	↓	26.360	26.375	26.340	↓	26.000	26.035	↓	26.372	26.003	↓
425	4.475	.033	↑	5.025	5.000	4.952	↑	4.500	4.548	↑	4.996	4.504	↑
426	4.600	.033		5.150	5.125	5.077		4.625	4.673		5.121	4.629	
427	4.725	.033	.275	5.275	5.250	5.202	.004	4.750	4.798	.004	5.246	4.754	.375
428	4.850	.033	±.006	5.400	5.375	5.327		4.875	4.923		5.371	4.879	
429	4.975	.037		5.525	5.500	5.452		5.000	5.048		5.496	5.004	
430	5.100	.037		5.650	5.625	5.577		5.125	5.173		5.621	5.129	
431	5.225	.037	↓	5.775	5.750	5.702	↓	5.250	5.298	↓	5.746	5.254	↓

† This groove width does not permit the use of Parbak rings. For pressures above 103.5 Bar (1500 psi), consult Design Chart 4-2 for groove widths where back-up rings must be used.

* These designs require considerable installation stretch. If assembly breakage is incurred, use a compound having higher elongation or use a two-piece piston.

Design Table 4-2: Gland Dimensions for Industrial O-Ring Static Seals, 103.5 Bar (1500 psi) Max.

⚠ WARNING: These products can expose you to chemicals including carbon black (airborne and extracts), antimony trioxide, titanium dioxide, silica (crystalline), di(2-ethylhexyl) phthalate, ethylene thiourea, acrylonitrile, 1,3-butadiene, epichlorohydrin, toluenediisocyanate, tetrafluoroethylene, ethylbenzene, formaldehyde, furfuryl alcohol, glass fibers, methyl isobutyl ketone, nickel (metallic and compounds), lead and lead compounds which are known to the State of California to cause cancer; and 1,3-butadiene, epichlorohydrin, di(2-ethylhexyl)phthalate, di-isodecyl phthalate, ethylene thiourea, methyl isobutyl ketone, methanol, toluene, lead and lead compounds which are known to the State of California to cause birth defects and other reproductive harm. For more information go to www.P65Warnings.ca.gov.

Gland Dimensions for Industrial O-Ring Static Seals, 103.5 Bar (1500 psi) Max.† (Continued)

O-Ring Size Parker No. 2-	Dimensions				A	A-1		B	B-1		C	D	G†
	ID	±	W	Mean OD (Ref)	Bore Dia. (Male Gland) +0.002 -0.000	Groove Dia. (Female Gland) -0.000	+	Tube OD (Female Gland) +0.000 -0.002	Groove Dia. (Male Gland) +0.000	-	Plug Dia. (Male Gland) +0.000 .001	Throat Dia. (Female Gland) +0.001 -0.000	Groove Width +0.005 -0.000
432	5.350	.037	↑	5.900	5.875	5.827	↑	5.375	5.423	↑	5.871	5.379	↑
433	5.475	.037		6.025	6.000	5.952		5.500	5.548		5.996	5.504	
434	5.600	.037		6.150	6.125	6.077		5.625	5.673		6.121	5.629	
435	5.725	.037		6.275	6.250	6.202		5.750	5.798		6.246	5.754	
436	5.850	.037		6.400	6.375	6.327		5.875	5.923		6.371	5.879	
437	5.975	.037		6.525	6.500	6.452		6.000	6.048		6.496	6.004	
438	6.225	.040		6.775	6.750	6.702		6.250	6.298		6.746	6.254	
439	6.475	.040		7.025	7.000	6.952		6.500	6.548		6.996	6.504	
440	6.725	.040		7.275	7.250	7.202		6.750	6.798		7.246	6.754	
441	6.975	.040		7.525	7.500	7.452		7.000	7.048		7.496	7.004	
442	7.225	.045		7.775	7.750	7.702		7.250	7.298		7.746	7.254	
443	7.475	.045		8.025	8.000	7.952		7.500	7.548		7.996	7.504	
444	7.725	.045		8.275	8.250	8.202		7.750	7.798		8.246	7.754	
445	7.975	.045		8.525	8.500	8.452		8.000	8.048		8.496	8.004	
446	8.475	.055		9.025	9.000	8.952		8.500	8.548		8.996	8.504	
447	8.975	.055		9.525	9.500	9.452		9.000	9.048		9.496	9.004	
448	9.475	.055		10.025	10.000	9.952		9.500	9.548		9.996	9.504	
449	9.975	.055		10.525	10.500	10.452		10.000	10.048		10.496	10.000	
450	10.475	.060		11.025	11.000	10.952		10.500	10.548		10.996	10.504	
451	10.975	.060		11.525	11.500	11.452		11.000	11.048		11.496	11.004	
452	11.475	.060		12.025	12.000	11.952		11.500	11.548		11.996	11.504	
453	11.975	.060		12.525	12.500	12.452		12.000	12.048		12.496	12.004	
454	12.475	.060	.275	13.025	13.000	12.952	.004	12.500	12.548	.004	12.996	12.504	.375
455	12.975	.060	±.006	13.525	13.500	13.452		13.000	13.048		13.496	13.004	
456	13.475	.070		14.025	14.000	13.952		13.500	13.548		13.996	13.504	
457	13.975	.070		14.525	14.500	14.452		14.000	14.048		14.496	14.004	
458	14.475	.070		15.025	15.000	14.952		14.500	14.548		14.996	14.504	
459	14.975	.070		15.525	15.500	15.452		15.000	15.048		15.496	15.004	
460	15.475	.070		16.025	16.000	15.952		15.500	15.548		15.996	15.504	
461	15.955	.075		16.505	16.500	16.452		16.000	16.048		16.496	16.004	
462	16.455	.075		17.005	17.000	16.952		16.500	16.548		16.996	16.504	
463	16.955	.080		17.505	17.500	17.452		17.000	17.048		17.496	17.004	
464	17.455	.085		18.005	18.000	17.952		17.500	17.548		17.996	17.504	
465	17.955	.085		18.505	18.500	18.452		18.000	18.048		18.496	18.004	
466	18.455	.085		19.005	19.000	18.952		18.500	18.548		18.996	18.504	
467	18.955	.090		19.505	19.500	19.452		19.000	19.048		19.496	19.004	
468	19.455	.090		20.005	20.000	19.952		19.500	19.548		19.996	19.504	
469	19.955	.095		20.505	20.500	20.452		20.000	20.048		20.496	20.004	
470	20.955	.095		21.505	21.500	21.452		21.000	21.048		21.496	21.004	
471	21.955	.100		22.505	22.500	22.452		22.000	22.048		22.496	22.004	
472	22.940	.105		23.490	23.500	23.452		23.000	23.048		23.496	23.004	
473	23.940	.110		24.490	24.500	24.452		24.000	24.048		24.496	24.004	
474	24.940	.115		25.490	25.500	25.452		25.000	25.048		25.496	25.004	
475	25.940	.120	↓	26.490	26.500	26.452	↓	26.000	26.048	↓	26.496	26.004	↓

† This groove width does not permit the use of Parbak rings. For pressures above 103.5 Bar (1500 psi), consult Design Chart 4-2 for groove widths where back-up rings must be used.

* These designs require considerable installation stretch. If assembly breakage is incurred, use a compound having higher elongation or use a two-piece piston.

Design Table 4-2: Gland Dimensions for Industrial O-Ring Static Seals, 103.5 Bar (1500 psi) Max.

⚠ WARNING: These products can expose you to chemicals including carbon black (airborne and extracts), antimony trioxide, titanium dioxide, silica (crystalline), di(2-ethylhexyl) phthalate, ethylene thiourea, acrylonitrile, 1,3-butadiene, epichlorohydrin, toluenediisocyanate, tetrafluoroethylene, ethylbenzene, formaldehyde, furfuryl alcohol, glass fibers, methyl isobutyl ketone, nickel (metallic and compounds), lead and lead compounds which are known to the State of California to cause cancer; and 1,3-butadiene, epichlorohydrin, di(2-ethylhexyl)phthalate, di-isodecyl phthalate, ethylene thiourea, methyl isobutyl ketone, methanol, toluene, lead and lead compounds which are known to the State of California to cause birth defects and other reproductive harm. For more information go to www.P65Warnings.ca.gov.

Face Seal Glands

For Internal Pressure
(outward pressure direction)
dimension the groove by its
outside diameter (H_o) and width:

(H_o) = Mean O.D. of O-ring
(see Table 4-1)
Tolerance = Minus 1% of Mean
O.D., but not more than
-.060

For External Pressure
(inward pressure direction)
dimension the groove by its
inside diameter (H_i) and width:

(H_i) = Mean I.D. of O-ring
(see Table 4-1)
Tolerance = Plus 1% of Mean
I.D., but not more than
+.060

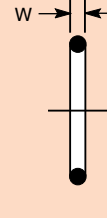
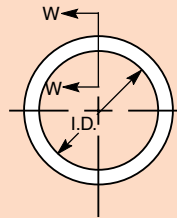
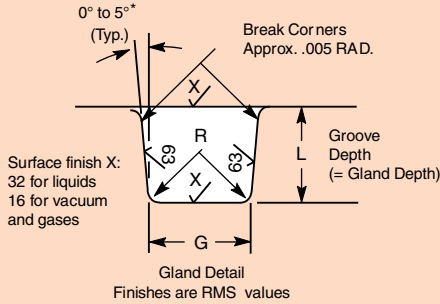
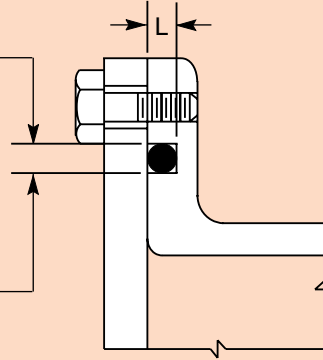

Section W-W

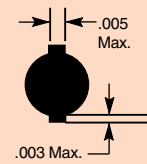

(Refer to Design Chart 4-3 below)

O-Ring Face Seal Glands These dimensions are intended primarily for face type O-ring seals and low temperature applications.

O-Ring Size Parker No. 2	W Cross Section		L Gland Depth	Squeeze		G Groove Width		R Groove Radius
	Nominal	Actual		Actual	%	Liquids	Vacuum and Gases	
004 through 050	1/16	.070 ±.003 (1.78 mm)	.050 to .054	.013 to .023	19 to 32	.101 to .107	.084 to .089	.005 to .015
102 through 178	3/32	.103 ±.003 (2.62 mm)	.074 to .080	.020 to .032	20 to 30	.136 to .142	.120 to .125	.005 to .015
201 through 284	1/8	.139 ±.004 (3.53 mm)	.101 to .107	.028 to .042	20 to 30	.177 to .187	.158 to .164	.010 to .025
309 through 395	3/16	.210 ±.005 (5.33 mm)	.152 to .162	.043 to .063	21 to 30	.270 to .290	.239 to .244	.020 to .035
425 through 475	1/4	.275 ±.006 (6.99 mm)	.201 to .211	.058 to .080	21 to 29	.342 to .362	.309 to .314	.020 to .035
Special	3/8	.375 ±.007 (9.52 mm)	.276 to .286	.082 to .106	22 to 28	.475 to .485	.419 to .424	.030 to .045
Special	1/2	.500 ±.008 (12.7 mm)	.370 to .380	.112 to .138	22 to 27	.638 to .645	.560 to .565	.030 to .045

Design Chart 4-3: Design Chart for O-Ring Face Seal Glands

WARNING: These products can expose you to chemicals including carbon black (airborne and extracts), antimony trioxide, titanium dioxide, silica (crystalline), di(2-ethylhexyl) phthalate, ethylene thiourea, acrylonitrile, 1,3-butadiene, epichlorohydrin, toluenediisocyanate, tetrafluoroethylene, ethylbenzene, formaldehyde, furfuryl alcohol, glass fibers, methyl isobutyl ketone, nickel (metallic and compounds), lead and lead compounds which are known to the State of California to cause cancer; and 1,3-butadiene, epichlorohydrin, di(2-ethylhexyl)phthalate, di-isodecyl phthalate, ethylene thiourea, methyl isobutyl ketone, methanol, toluene, lead and lead compounds which are known to the State of California to cause birth defects and other reproductive harm. For more information go to www.P65Warnings.ca.gov.

Dovetail Grooves

It is often necessary to provide some mechanical means for holding an O-ring in a face seal groove during assembly and maintenance of equipment. An undercut or dovetail groove has proven beneficial in many applications to keep the O-ring in place. This is an expensive groove to machine, however, and thus should be used only when absolutely necessary.

It should be noted that although this method has been used successfully, it is not generally recommended. The inherent characteristics of the groove design limit the amount of void area. Normally acceptable tolerance extremes, wide service temperature ranges, and fluid media that cause high swell of the elastomer are conditions that cannot be tolerated in this type of groove design.

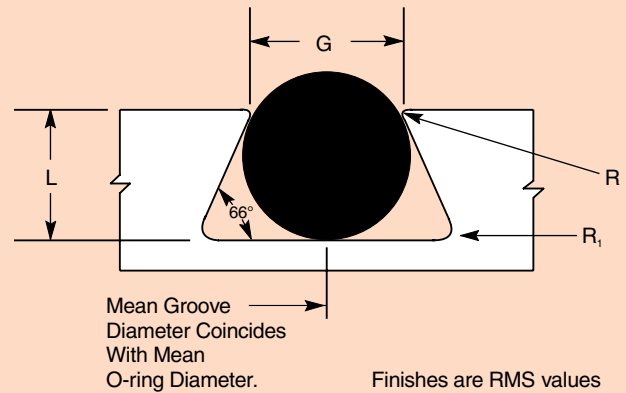

O-Ring Dovetail Grooves

Radius "R" is CRITICAL. Insufficient radius will potentially cause damage to the O-ring during installation, while excessive radius may contribute to extrusion.

O-Ring Size AS568A-	W Cross Section		L Gland Depth	Squeeze %	G Groove Width (To sharp corner)	R	R ₁
	Nominal	Actual					
004 through 050	1/16	.070 ±.003	.053 to .055	23	.057 to .061	.005	1/64
102 through 178	3/32	.103 ±.003	.081 to .083	21	.083 to .087	.010	1/64
201 through 284	1/8	.139 ±.004	.111 to .113	20	.113 to .117	.010	1/32
309 through 395	3/16	.210 ±.005	.171 to .173	18	.171 to .175	.015	1/32
425 through 475	1/4	.275 ±.006	.231 to .234	16	.231 to .235	.015	1/16
Special	3/8	.375 ±.007	.315 to .319	16	.315 to .319	.020	3/32

NOTE: These design recommendations assume metal-to-metal contact. In special applications, for example in the semiconductor industry, deviation from these recommendations may be necessary. When designing with Parofluor elastomers, one should take into consideration that perfluorinated elastomers may require more squeeze than an FKM material to obtain optimum sealing performance. To increase squeeze, modifications of the design recommendations shown above are necessary.

Design Chart 4-4: Dovetail Grooves

WARNING: These products can expose you to chemicals including carbon black (airborne and extracts), antimony trioxide, titanium dioxide, silica (crystalline), di(2-ethylhexyl) phthalate, ethylene thiourea, acrylonitrile, 1,3-butadiene, epichlorohydrin, toluenediisocyanate, tetrafluoroethylene, ethylbenzene, formaldehyde, furfuryl alcohol, glass fibers, methyl isobutyl ketone, nickel (metallic and compounds), lead and lead compounds which are known to the State of California to cause cancer; and 1,3-butadiene, epichlorohydrin, di(2-ethylhexyl)phthalate, di-isodecyl phthalate, ethylene thiourea, methyl isobutyl ketone, methanol, toluene, lead and lead compounds which are known to the State of California to cause birth defects and other reproductive harm. For more information go to www.P65Warnings.ca.gov.

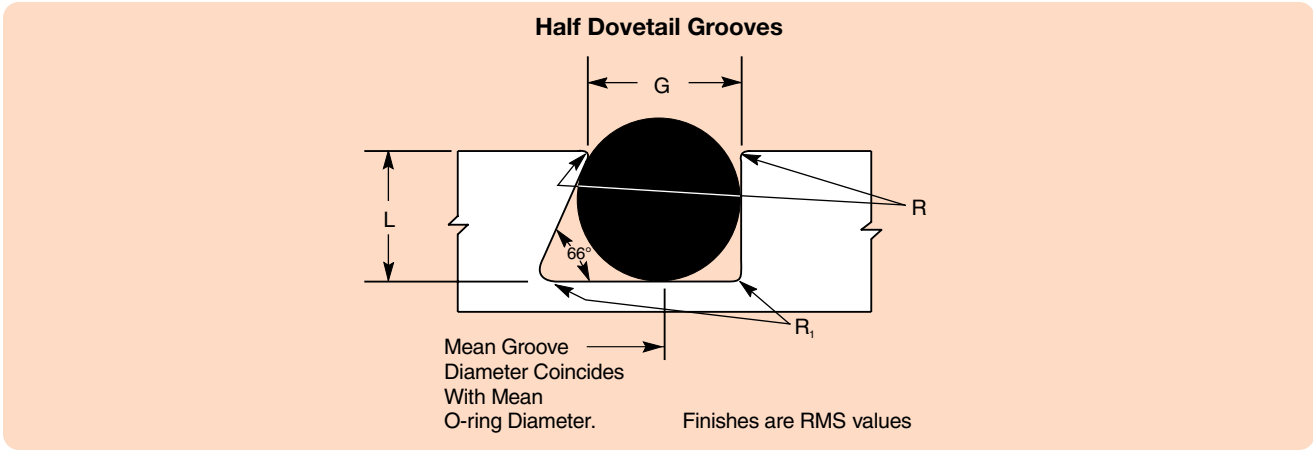

O-Ring Half Dovetail Grooves

Radius "R" is CRITICAL. Insufficient radius will potentially cause damage to the O-ring during installation, while excessive radius may contribute to extrusion.

O-Ring Size AS568A-	W Cross Section		L Gland Depth	Squeeze %	G Groove Width (To sharp corner)	R	R ₁
	Nominal	Actual					
004 through 050	1/16	.070 ±.003	.053 to .055	23	.064 to .066	.005	1/64
102 through 178	3/32	.103 ±.003	.083 to .085	19	.095 to .097	.010	1/64
201 through 284	1/8	.139 ±.004	.113 to .115	18	.124 to .128	.010	1/32
309 through 395	3/16	.210 ±.005	.173 to .176	17	.190 to .193	.015	1/32
425 through 475	1/4	.275 ±.006	.234 to .238	15	.255 to .257	.015	1/16
Special	3/8	.375 ±.007	.319 to .323	14	.350 to .358	.020	3/32

NOTE: These design recommendations assume metal-to-metal contact. In special applications, for example in the semiconductor industry, deviation from these recommendations may be necessary. When designing with Parofluor elastomers, one should take into consideration that perfluorinated elastomers may require more squeeze than an FKM material to obtain optimum sealing performance. To increase squeeze, modifications of the design recommendations shown above are necessary.

Design Chart 4-5: Half Dovetail Grooves

WARNING: These products can expose you to chemicals including carbon black (airborne and extracts), antimony trioxide, titanium dioxide, silica (crystalline), di(2-ethylhexyl) phthalate, ethylene thiourea, acrylonitrile, 1,3-butadiene, epichlorohydrin, toluenediisocyanate, tetrafluoroethylene, ethylbenzene, formaldehyde, furfuryl alcohol, glass fibers, methyl isobutyl ketone, nickel (metallic and compounds), lead and lead compounds which are known to the State of California to cause cancer; and 1,3-butadiene, epichlorohydrin, di(2-ethylhexyl)phthalate, di-isodecyl phthalate, ethylene thiourea, methyl isobutyl ketone, methanol, toluene, lead and lead compounds which are known to the State of California to cause birth defects and other reproductive harm. For more information go to www.P65Warnings.ca.gov.

Triangular Grooves

This type of crush seal is used where cost and ease of machining are important. The O-Ring is confined in a triangular recess made by machining a 45 degree angle on the male cover. The OD of the ring should be about the same as the recess diameter. The same sealing principle applies to crush type seals used in recesses of straight thread tubing bosses. Pressures are limited only by clearances and the strength of the mating parts. The O-Rings are permanently deformed.

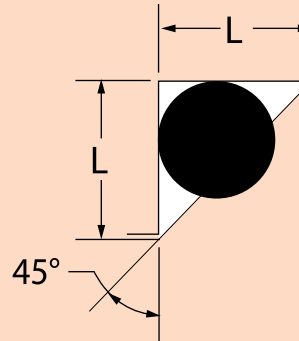

Static Crush Seal Grooves

Size Number	W O-Ring CS Actual				L Gland Depth			
	in	+/-	mm	+/-	in	+ (- 0.000)	mm	+ (- 0.000)
004 through 050	0.070	0.003	1.78	0.08	0.092	0.003	2.34	0.08
102 through 178	0.103	0.003	2.62	0.08	0.136	0.005	3.45	0.13
201 through 284	0.139	0.004	3.53	0.10	0.184	0.007	4.67	0.18
309 through 395	0.210	0.005	5.33	0.13	0.277	0.010	7.04	0.25
425 through 475	0.275	0.006	6.99	0.15	0.363	0.015	9.22	0.38
Various Sizes	0.059	0.003	1.50	0.08	0.078	0.003	1.98	0.08
	0.078	0.003	2.00	0.08	0.104	0.003	2.64	0.08
	0.098	0.003	2.50	0.08	0.130	0.005	3.30	0.13
	0.118	0.004	3.00	0.10	0.156	0.005	3.96	0.13
	0.157	0.005	4.00	0.13	0.208	0.007	5.28	0.18
	0.197	0.005	5.00	0.13	0.260	0.010	6.61	0.25
	0.236	0.006	6.00	0.15	0.312	0.010	7.93	0.25
	0.315	0.007	8.00	0.18	0.416	0.015	10.57	0.38
0.354	0.007	9.00	0.18	0.468	0.015	11.89	0.38	

Design Chart 4-6: Static Crush Seal Grooves

WARNING: These products can expose you to chemicals including carbon black (airborne and extracts), antimony trioxide, titanium dioxide, silica (crystalline), di(2-ethylhexyl) phthalate, ethylene thiourea, acrylonitrile, 1,3-butadiene, epichlorohydrin, toluenediisocyanate, tetrafluoroethylene, ethylbenzene, formaldehyde, furfuryl alcohol, glass fibers, methyl isobutyl ketone, nickel (metallic and compounds), lead and lead compounds which are known to the State of California to cause cancer; and 1,3-butadiene, epichlorohydrin, di(2-ethylhexyl)phthalate, di-isodecyl phthalate, ethylene thiourea, methyl isobutyl ketone, methanol, toluene, lead and lead compounds which are known to the State of California to cause birth defects and other reproductive harm. For more information go to www.P65Warnings.ca.gov.

Tube Fitting Boss Seals

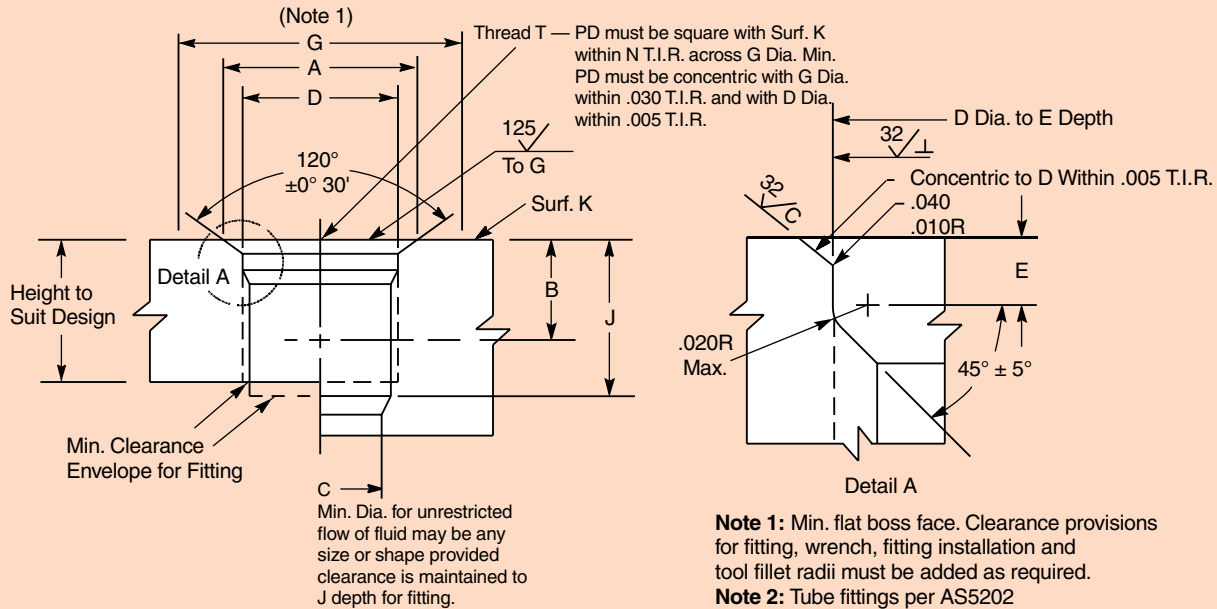

Boss Dimensions for Military Straight Thread Tube Fitting O-ring Gaskets per AS5202 (Supersedes AND10049, AND10050 and MS33649)

Parker O-ring Size No.*	Actual O-Ring Dimensions		Equiv. Tube Dash No.	Tube OD Min.	Thread T Per Mil-S-8879	A Dia. +.015 -0.000	B Full Thd. Depth	C Dia.	D Dia.		E +.015 -0.000	G Dia. Min.	J Min.	N
	W	ID							+0.005	-0.000				
3-901	.056 ± .003	.185 ± .005	1	-	.2500-28UNJF-3B	0.359	0.330	0.062	0.264	0.063	0.478	0.402	0.002	
3-902	.064 ± .003	.239 ± .005	2	.125	.3125-24UNJF-3B	0.438	0.482	0.062	0.328	0.063	0.602	0.577	0.003	
3-903	.064 ± .003	.301 ± .005	3	.188	.3750-24UNJF-3B	0.500	0.538	0.125	0.390	0.075	0.665	0.583		
3-904	.072 ± .003	.351 ± .005	4	.250	.4375-20UNJF-3B	0.562	0.568	0.172	0.454	0.075	0.728	0.656		
3-905	.072 ± .003	.414 ± .005	5	.312	.5000-20UNJF-3B	0.625		0.234	0.517	0.075	0.790			
3-906	.078 ± .003	.468 ± .005	6	.375	.5625-18UNJF-3B	0.688	0.598	0.297	0.580	0.083	0.852	0.709	0.004	
3-907	.082 ± .003	.530 ± .007	7	.438	.6250-18UNJF-3B	0.750	0.614	0.360	0.643	0.094	0.915	0.725		
3-908	.087 ± .003	.644 ± .009	8	.500	.7500-16UNJF-3B	0.875	0.714	0.391	0.769	0.107	1.040	0.834	0.005	
3-909	.097 ± .003	.706 ± .009	9	.562	.8125-16UNJ-3B	0.938	0.730	0.438	0.832	0.107	1.102	0.850		
3-910	.097 ± .003	.755 ± .009	10	.625	.8750-14UNJF-3B	1.000	0.802	0.484	0.896	0.107	1.165	0.960		
3-911	.116 ± .004	.863 ± .009	11	.688	1.0000-12UNJF-3B	1.156	0.877	0.547	1.023	0.125	1.352	1.064		0.008
3-912	.116 ± .004	.924 ± .009	12	.750	1.0625-12UNJ-3B	1.234		0.609	1.086	0.125	1.415			
3-914	.116 ± .004	1.047 ± .010	14	.875	1.1875-12UNJ-3B	1.362		0.734	1.211	0.125	1.540			
3-916	.116 ± .004	1.171 ± .010	16	1.000	1.3125-12UNJ-3B	1.487		0.844	1.336	0.125	1.665			
3-918	.116 ± .004	1.355 ± .012	18	1.125	1.5000-12UNJF-3B	1.675	0.907	0.953	1.524	0.125	1.790	1.116	0.010	
3-920	.118 ± .004	1.475 ± .014	20	1.250	1.6250-12UNJ-3B	1.800		1.078	1.648	0.125	1.978			
3-924	.118 ± .004	1.720 ± .014	24	1.500	1.8750-12UNJ-3B	2.050		1.312	1.898	0.125	2.228	1.127		
3-928	.118 ± .004	2.090 ± .018	28	1.750	2.2500-12UNJ-3B	2.425		1.547	2.273	0.125	2.602	1.243		
3-932	.118 ± .004	2.337 ± .018	32	2.000	2.5000-12UNJ-3B	2.675	1.781	2.524	0.125	2.852	1.368			

*Parker dash numbers correspond with those of AS568A

Design Table 4-3: Boss Dimensions for Military Straight Thread Tube Fitting O-ring Gaskets per AS5202 (Supersedes AND10049, AND10050 and MS33649)

WARNING: These products can expose you to chemicals including carbon black (airborne and extracts), antimony trioxide, titanium dioxide, silica (crystalline), di(2-ethylhexyl) phthalate, ethylene thiourea, acrylonitrile, 1,3-butadiene, epichlorohydrin, toluenediisocyanate, tetrafluoroethylene, ethylbenzene, formaldehyde, furfuryl alcohol, glass fibers, methyl isobutyl ketone, nickel (metallic and compounds), lead and lead compounds which are known to the State of California to cause cancer; and 1,3-butadiene, epichlorohydrin, di(2-ethylhexyl)phthalate, di-isodecyl phthalate, ethylene thiourea, methyl isobutyl ketone, methanol, toluene, lead and lead compounds which are known to the State of California to cause birth defects and other reproductive harm. For more information go to www.P65Warnings.ca.gov.

Tube Fitting Boss Seals

Use fitting end per AS4395

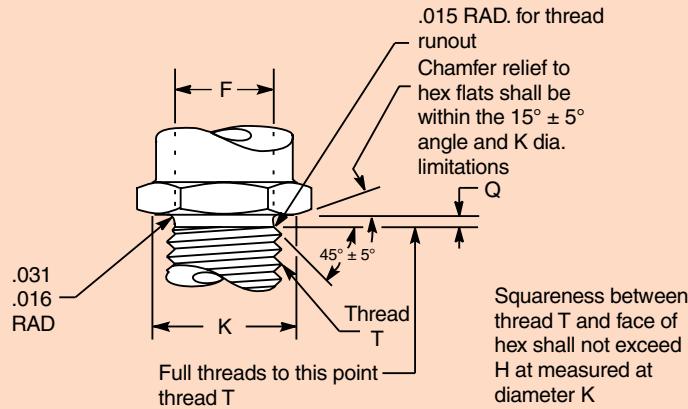

Fitting End AS4395 Used with J1926/1 and AS5202 Bosses (Supercedes MS 33656)
 (Only the dimensions that define the O-ring Cavity are shown below.)

Parker O-ring Size No.	Tubing OD	Thread T		E Dimension Across Hex Flats	F +.002 - .003	H Max.	K Dia. ±.010	G +.015 - .000	
3-902	1/8	5/16-24	UNF-3A	.563	.250	.005	.549	.063	
3-903	3/16	3/8-24		.625	.312		.611	.063	
3-904	1/4	7/16-20		.688	.364		.674	.075	
3-905	5/16	1/2-20		.750	.426		.736	.075	
3-906	3/8	9/16-18		.813	.481		.799	.083	
3-908	1/2	3/4-16		1.000	.660		.986	.094	
3-910	5/8	7/8-14		1.125	.773		1.111	.107	
3-912	3/4	1 1/16-12	UNJ-3A	1.375	.945	.008	1.361	.125	
3-914*	7/8	1 3/16-12		1.500	1.070		1.475		
3-916	1	1 5/16-12		1.625	1.195		1.599		
3-920	1 1/4	1 5/8-12		1.875	1.507		1.879		
3-924	1 1/2	1 7/8-12		2.125	1.756		2.095		
3-932	2	2 1/2-12		2.750	±.016		1.95		1.599
					±.020		2.381		2.718

*No fitting end for the 3-914 O-ring size is included in AS4395, but the dimensions shown here follow the same pattern.

Design Table Table 4-4: Fitting end AS4395 used with J1926/1 and AS5202 bosses (only the dimensions that define the O-ring cavity are shown.)

WARNING: These products can expose you to chemicals including carbon black (airborne and extracts), antimony trioxide, titanium dioxide, silica (crystalline), di(2-ethylhexyl) phthalate, ethylene thiourea, acrylonitrile, 1,3-butadiene, epichlorohydrin, toluenediisocyanate, tetrafluoroethylene, ethylbenzene, formaldehyde, furfuryl alcohol, glass fibers, methyl isobutyl ketone, nickel (metallic and compounds), lead and lead compounds which are known to the State of California to cause cancer; and 1,3-butadiene, epichlorohydrin, di(2-ethylhexyl)phthalate, di-isodecyl phthalate, ethylene thiourea, methyl isobutyl ketone, methanol, toluene, lead and lead compounds which are known to the State of California to cause birth defects and other reproductive harm. For more information go to www.P65Warnings.ca.gov.

Tube Fitting Boss Seals

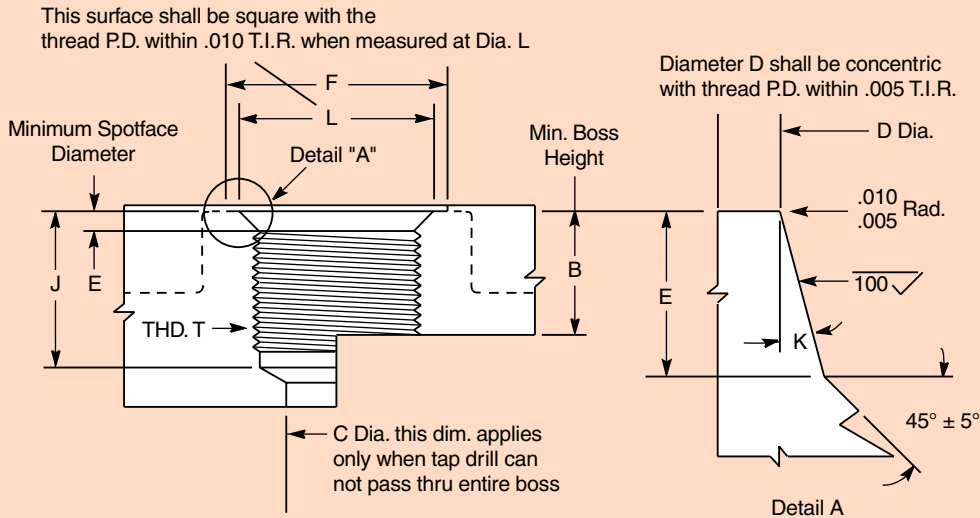

Finished tapered counterbore (Detail A) shall be free from longitudinal and spiral tool marks. Annular tool marks up to 100 micro-inches maximum will be permissible.

Boss Dimensions for Industrial Straight Thread Tube Fittings O-Ring Gaskets per SAE J1926

Parker O-Ring Size	Actual O-Ring Dimensions		Tube OD	Thread T		B Min. Thread Depth	C Min.	D +.005 - .000	E +.015 - .000	F Min.	J Min.	K ±1°	L Min.	
	W	ID												
3-902	.064 ± .003	.239 ± .005	1/8	5/16-24	UNF-2B	.390	.062	.358	.074	.672	.468	12°	.438	
3-903	.064 ± .003	.301 ± .005	3/16	3/8-24		.390	.125	.421	.074	.750	.468	12°	.500	
3-904	.072 ± .003	.351 ± .005	1/4	7/16-20		.454	.172	.487	.093	.828	.547	12°	.563	
3-905	.072 ± .003	.414 ± .005	5/16	1/2-20		.454	.234	.550	.093	.960	.547	12°	.625	
3-906	.078 ± .003	.468 ± .005	3/8	9/16-18		.500	.297	.616	.097	.906	.609	12°	.688	
3-908	.087 ± .003	.644 ± .009	1/2	3/4-16		.562	.391	.811	.100	1.188	.688	15°	.875	
3-910	.097 ± .003	.755 ± .009	5/8	7/8-14	UN-2B	.656	.484	.942	.100	1.344	.781	15°	1.000	
3-912	.116 ± .004	.924 ± .009	3/4	1 1/16-12		.750	.609	1.148	.130	1.625	.906	15°	1.250	
3-913	.116 ± .004	.986 ± .010	13/16			UN-2B	.750	.719	1.273	.130	1.765	.906	15°	1.375
3-914	.116 ± .004	1.047 ± .010	7/8	1 3/16-12										
3-916	.116 ± .004	1.171 ± .010	1	1 5/16-12										
3-918	.116 ± .004	1.355 ± .012	1 1/8											
3-920	.118 ± .004	1.475 ± .014	1 1/4	1 5/8-12	.750	1.078	1.713	.132	2.270	.906	15°	1.875		
3-924	.118 ± .004	1.720 ± .014	1 1/2	1 7/8-12	.750	1.312	1.962	.132	2.560	.906	15°	2.125		
3-932	.118 ± .004	2.337 ± .018	2	2 1/2-12	.750	1.781	2.587	.132	3.480	.906	15°	2.750		

Design Table 4-5: Boss Dimensions for Industrial Straight Thread Tube Fitting O-ring Gaskets Per SAE J1926

WARNING: These products can expose you to chemicals including carbon black (airborne and extracts), antimony trioxide, titanium dioxide, silica (crystalline), di(2-ethylhexyl) phthalate, ethylene thiourea, acrylonitrile, 1,3-butadiene, epichlorohydrin, toluenediisocyanate, tetrafluoroethylene, ethylbenzene, formaldehyde, furfuryl alcohol, glass fibers, methyl isobutyl ketone, nickel (metallic and compounds), lead and lead compounds which are known to the State of California to cause cancer; and 1,3-butadiene, epichlorohydrin, di(2-ethylhexyl)phthalate, di-isodecyl phthalate, ethylene thiourea, methyl isobutyl ketone, methanol, toluene, lead and lead compounds which are known to the State of California to cause birth defects and other reproductive harm. For more information go to www.P65Warnings.ca.gov.

For Static Vacuum Seal Glands

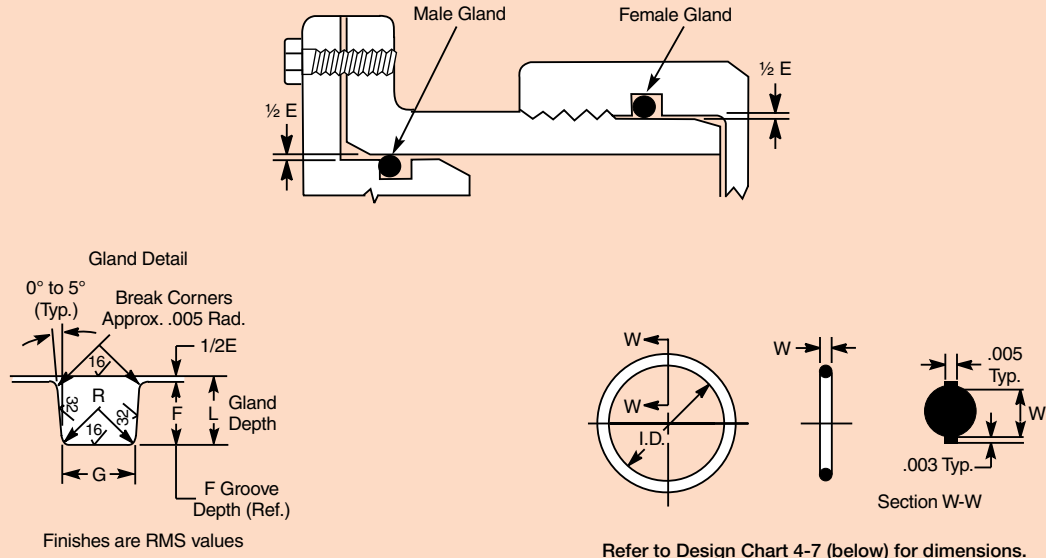

Design Chart Static Vacuum Seal Glands

O-Ring Size AS568A-	W Cross-Section		L Gland Depth	Squeeze		E Diametral Clearance	G Groove Width	R Groove Radius	Max.* Eccentricity
	Nominal	Actual		Actual	%				
004 through 050	1/16	.070 ±.003	.050 to .052	.015 to .023	22 to 32	.002 to .005	.093 to .098	.005 to .015	.002
102 through 178	3/32	.103 ±.003	.081 to .083	.017 to .025	17 to 24	.002 to .005	.140 to .145	.005 to .015	.002
201 through 284	1/8	.139 ±.004	.111 to .113	.022 to .032	16 to 23	.003 to .006	.187 to .192	.010 to .025	.003
309 through 395	3/16	.210 ±.005	.170 to .173	.032 to .045	15 to 21	.003 to .006	.281 to .286	.020 to .035	.004
425 through 475	1/4	.275 ±.006	.226 to .229	.040 to .055	15 to 20	.004 to .007	.375 to .380	.020 to .035	.005

*Total indicator reading between groove and adjacent bearing surface.

Design Chart 4-7: Design Chart for Static Vacuum Seal Glands

WARNING: These products can expose you to chemicals including carbon black (airborne and extracts), antimony trioxide, titanium dioxide, silica (crystalline), di(2-ethylhexyl) phthalate, ethylene thiourea, acrylonitrile, 1,3-butadiene, epichlorohydrin, toluenediisocyanate, tetrafluoroethylene, ethylbenzene, formaldehyde, furfuryl alcohol, glass fibers, methyl isobutyl ketone, nickel (metallic and compounds), lead and lead compounds which are known to the State of California to cause cancer; and 1,3-butadiene, epichlorohydrin, di(2-ethylhexyl)phthalate, di-isodecyl phthalate, ethylene thiourea, methyl isobutyl ketone, methanol, toluene, lead and lead compounds which are known to the State of California to cause birth defects and other reproductive harm. For more information go to www.P65Warnings.ca.gov.

 **WARNING:** These products can expose you to chemicals including carbon black (airborne and extracts), antimony trioxide, titanium dioxide, silica (crystalline), di(2-ethylhexyl) phthalate, ethylene thiourea, acrylonitrile, 1,3-butadiene, epichlorohydrin, toluenediisocyanate, tetrafluoroethylene, ethylbenzene, formaldehyde, furfuryl alcohol, glass fibers, methyl isobutyl ketone, nickel (metallic and compounds), lead and lead compounds which are known to the State of California to cause cancer; and 1,3-butadiene, epichlorohydrin, di(2-ethylhexyl)phthalate, di-isodecyl phthalate, ethylene thiourea, methyl isobutyl ketone, methanol, toluene, lead and lead compounds which are known to the State of California to cause birth defects and other reproductive harm. For more information go to www.P65Warnings.ca.gov.

Section V – Dynamic O-Ring Sealing

5.1 Introduction	5-2	5.16 Modifications for Special Applications	5-14
5.2 Hydraulic Reciprocating O-Ring Seals	5-2	5.16.1 Small Amount of Leakage	5-15
5.3 Surface Finishes	5-3	5.16.2 Early Stress-Aging	5-15
5.4 Temperature Effects on Dynamic Seals	5-5	5.16.3 Low Temperature Leakage	5-15
5.5 Side Loads	5-5	5.16.4 Excessive Swell (above 20%)	5-15
5.6 Direction of Pressure	5-5	5.17 Gland Dimensions for Reciprocating Hydraulic O-Ring Seals	5-15
5.7 Shock Loads and Pressures	5-5	5.18 Floating Glands	5-15
5.8 High Frequency Motion or Vibration	5-6	5.19 Pneumatic Reciprocating O-Ring Seals	5-16
5.9 Squeeze	5-6	5.20 Temperature	5-16
5.10 Stretch	5-6	5.21 Silicone Compounds	5-16
5.11 Friction	5-7	5.22 High-Pressure	5-16
5.11.1 Break-Out Friction	5-7	5.23 Lubrication	5-16
5.11.2 Running Friction	5-7	5.24 Gland Dimensions	5-16
5.12 Calculate Rubbing Surface	5-8	5.25 Floating Seal	5-16
5.13 Methods to Reduce Friction	5-8	5.26 Uni-Directional Gland	5-17
5.14 Friction and Wear	5-8	5.27 Rotary Seal	5-17
5.14.1 Friction	5-8	5.28 Oscillating Seal	5-19
5.14.2 Pneumatic Seals	5-11	5.29 Seat Seal	5-19
5.14.3 Wear	5-12	5.30 Drive Belts	5-20
5.14.4 Interdependence of Friction Wear and an Effective Seal	5-12	5.30.1 Calculation of Drive Belt Open Design	5-20
5.15 Spiral Failure	5-13	5.30.2 Calculation of Drive Belt Crossed Design	5-21
5.15.1 Speed of Stroke	5-14	5.31 O-Ring Glands	5-21
5.15.2 Lack of Lubrication	5-14	5.31.1 O-Ring Glands for Aerospace Hydraulic Packings and Gaskets	5-21
5.15.3 Pressure Differential and Direction	5-14	5.31.2 O-Ring Glands for Industrial Reciprocating Seals	5-30
5.15.4 Squeeze	5-14	5.31.3 O-Ring Glands for Pneumatic Floating Piston Ring Seals	5-35
5.15.5 Shape of Groove and Split Groove	5-14	5.31.4 O-Ring Glands for Rotary Seals	5-39
5.15.6 Temperature of Operation	5-14	5.32 Dynamic Vacuum Sealing	5-44
5.15.7 Length of Stroke	5-14		
5.15.8 Surface Finish	5-14		
5.15.9 Back-Up Rings	5-14		

WARNING: These products can expose you to chemicals including carbon black (airborne and extracts), antimony trioxide, titanium dioxide, silica (crystalline), di(2-ethylhexyl) phthalate, ethylene thiourea, acrylonitrile, 1,3-butadiene, epichlorohydrin, toluenediisocyanate, tetrafluoroethylene, ethylbenzene, formaldehyde, furfuryl alcohol, glass fibers, methyl isobutyl ketone, nickel (metallic and compounds), lead and lead compounds which are known to the State of California to cause cancer; and 1,3-butadiene, epichlorohydrin, di(2-ethylhexyl)phthalate, di-isodecyl phthalate, ethylene thiourea, methyl isobutyl ketone, methanol, toluene, lead and lead compounds which are known to the State of California to cause birth defects and other reproductive harm. For more information go to www.P65Warnings.ca.gov.

Dynamic O-Ring Sealing

5.1 Introduction

Dynamic O-ring sealing applications are considerably more involved than static applications due to the implied motion against the O-ring seal interface. Resistance to fluids must be more carefully scrutinized than in conventional static seal designs since a volumetric increase in the O-ring in excess of approximately 20% may lead to friction and wear difficulties, and only a minimum of shrinkage (at most 4%), can be tolerated.

The metal or other surface over which the O-ring will move also becomes critical. It must be hard and wear resistant. It also must be sufficiently smooth so that it will not abrade the rubber, and yet there must be small microfine “pockets” on the moving surfaces to hold lubricant.

The greatest dynamic use of O-rings is in reciprocating hydraulic rod and piston seals. These are discussed first, but many of the ideas expressed are also applicable to other dynamic applications. Considerations applying only to other types of dynamic seals are discussed in greater detail later in the section.

5.2 Hydraulic Reciprocating O-ring Seals

O-rings are best when used on short-stroke, relatively small-diameter applications. Millions of O-rings however, are used very successfully in reciprocating hydraulic, pneumatic, and other fluid systems which employ long stroke, large diameter seals. If designed properly, an O-ring seal will give long, trouble-free service. The following discussion is presented so that common troubles and misuses can be avoided.

If the engineer or designer is to become his own seal expert, he must learn the basic types and causes of seal failure. In this section we present a discussion of failures and causes of various seal failure modes even though it may overemphasize the problems.

Reciprocating seals are affected by extrusion, breathing, surface finish of the metal, and hardness of the seal as discussed in O-Ring Applications, Section III. These factors should therefore be considered in any reciprocating gland design. There are also additional factors discussed in this chapter that must be considered in order to avoid future difficulty.

Materials for the surface(s) over which moving O-rings slide should be chosen carefully. Those that give the maximum life to moving O-ring seals are: Cast iron or steel for bores, hardened steel for rods, or hard chrome plated surfaces.

Soft metals such as aluminum, brass, bronze, monel and some stainless steels should be avoided in most dynamic applications, although they may be used in low-pressure pneumatics. If the cylinder bore surface can be hardened, as by carburizing, cylinder life will be increased. Hardness of the piston should always be lower than the cylinder walls to minimize the possibility of damage to the cylinder bore surface.

Preferably, metallic moving surfaces sealed by an O-ring should never touch, but if they must, then the one containing the O-ring groove should be a soft bearing material. It is impossible to run a highly polished piston rod through a hard bearing without inflicting scratches on the rod. It is likewise impossible to slide a hard piston in a highly polished cylinder and not inflict scratches on the cylinder wall. The scratches are usually caused by small hard particles that are loosened and picked up by the oil which sooner or later become jammed between the moving surfaces and score them. Though they may be hairlines, they are longitudinal scratches and will therefore reduce sealing efficiency and life of the O-ring.

The most satisfactory bearing material tried for this purpose is babbitt metal. Babbitt makes an excellent bearing and the hard particles become imbedded and captured in it without damage to the hardened rod. In fact after millions of cycles, the babbitt imparts a glass-like finish to the rod. Nylon may also be used as a bearing material, but the bearing may need to be split in some fashion to allow for nylon’s relatively high coefficient of thermal expansion.

In a suggested design, Figure 5-1, the piston is surfaced with babbitt. The gland is also lined with babbitt. The O-ring may be located in the babbitt lining or in the supporting metal which should be relieved 0.051 or 0.076 mm (0.002 or 0.003 inches) so there will be no chance of the hard metals running together.

Lubrication, as explained in O-Ring Application, Section III, is useful in all O-ring seals. It is doubly important in dynamic applications where a lubricating film between the O-ring, and the surface it slides over, will protect the ring from abrasion, frictional heating and rapid wear.

In pneumatic applications, a back-up ring will trap some lubricant, and extend the useful life of seals that are lubricated infrequently. It will also help retain oil in applications powered with lubricated air.

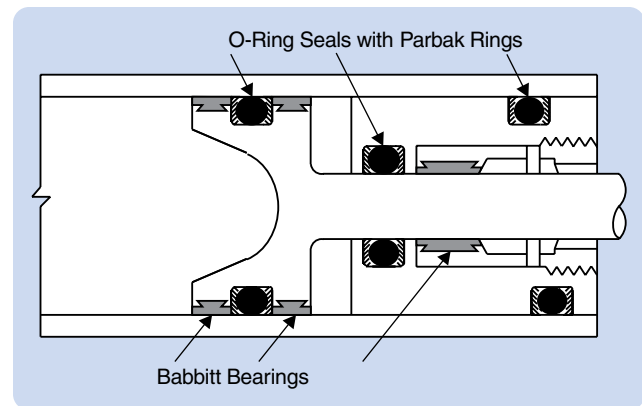

Figure 5-1: O-ring Seals with Bearings

WARNING: These products can expose you to chemicals including carbon black (airborne and extracts), antimony trioxide, titanium dioxide, silica (crystalline), di(2-ethylhexyl) phthalate, ethylene thiourea, acrylonitrile, 1,3-butadiene, epichlorohydrin, toluenediisocyanate, tetrafluoroethylene, ethylbenzene, formaldehyde, furfuryl alcohol, glass fibers, methyl isobutyl ketone, nickel (metallic and compounds), lead and lead compounds which are known to the State of California to cause cancer; and 1,3-butadiene, epichlorohydrin, di(2-ethylhexyl)phthalate, di-isodecyl phthalate, ethylene thiourea, methyl isobutyl ketone, methanol, toluene, lead and lead compounds which are known to the State of California to cause birth defects and other reproductive harm. For more information go to www.P65Warnings.ca.gov.

When a cylinder rod extends out into a dirty environment where it can pick up dirt, lint, metal chips, etc., this foreign material can nullify the effect of the best lubricant and cause rapid abrasive wear of both the O-ring and the rod. Equipment exposed to such conditions should be fitted with a wiper/scraper ring to prevent the dirt from reaching the O-ring seal. It is also good practice to install a felt ring between the scraper and the seal to insure proper lubrication of the rod on its return stroke. Figure 5-2 illustrates this concept.

A felt ring may cause corrosion in some installations, as felt also tends to collect moisture. A second O-ring may be used for the wiper, but it must not actually seal because a pressure trap condition is likely to develop between two reciprocating

O-ring seals. This can be prevented by cutting the outer O-ring so it cannot seal. Since this can easily be forgotten, it is preferable to provide a vent hole between the two O-rings. It should vent downward so it will not become clogged with dirt. The sample problem provided in Table 5-1 explains how to design the gland for such an O-ring wiper.

5.3 Surface Finishes

Finishes of contact surfaces have much to do with the life of dynamic O-ring seals. Limits of maximum roughness for glands are given on the drawings accompanying the design charts in this section and represent accepted practice for military and industrial use. Surface roughness values less than 5 micro-inches are not recommended for dynamic seals, however, as an extending rod will be wiped completely dry and will not be lubricated when it retracts. The surface must be rough enough to hold small amounts of oil. Ideally, a microscopic “orange peel” type of surface is best, presenting smooth rounded surfaces for the O-ring to slide on, with small crevices between to act as oil reservoirs. This kind of surface may be approximated by peening the rod with metal shot or glass beads. An even better surface can be obtained by electropolishing. The most desirable surface roughness value is from 10 to 20 micro-inches.

The roughness of a surface as measured comprises several elements which can be handled separately according to DIN 4760:

- Level 1 — dimensional deviations within tolerance band
- Level 2 — surface undulations (waves)
- Levels 3 to 5 — range of roughness

All these deviations from the ideal finish are superimposed as measurements are carried out and represent the surface roughness (see Figure 5-3).

Surface finish is often quantified in terms of R_t and R_a (see Figure 5-4). R_t is the vertical distance between the highest and the lowest peaks in a roughness profile over a test length l_m . R_t is increasingly being replaced by the maximum depth of roughness, R_{max} . R_{max} is the greatest single roughness found in five consecutive single trace lengths l_m .

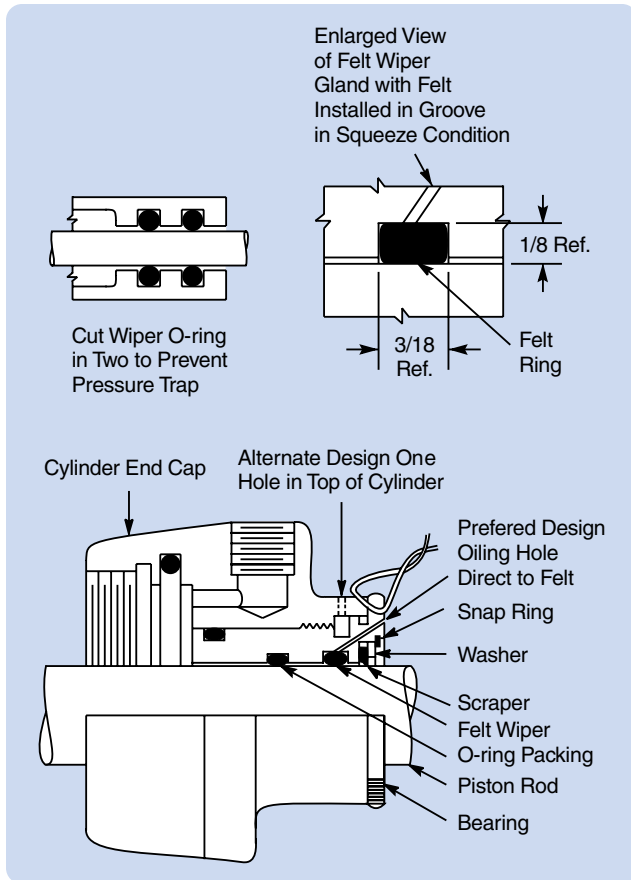

Figure 5-2: Lubrication Between Scraper and Seal Rings

Problem: To design a wiper gland for a 25.4 mm (1.000 in.) OD piston rod.	
Procedural Steps:	Example:
(A) Select O-ring with actual ID slightly smaller than Rod OD, B.	(A) Parker No. 2-214 (ID = 0.984)
(B) Divide the actual minimum squeeze given in Design Chart A6-5 for this O-ring size by two (the same squeeze is permissible in most cases).	(B) Squeeze $0.012/2 = 0.006$
(C) Add this amount to both max. and min. gland depth, L, given in Design Chart A6-5 to get proper gland depth for wiper, L_w .	(C) $L_w \text{ min} = 0.121 + .006 = 0.127$ $L_w \text{ max} = 0.123 + .006 = 0.129$
(D) Calculate balance of gland dimensions same as for piston rod seal.	

Table 5-1: Wiper Gland Design Example

WARNING: These products can expose you to chemicals including carbon black (airborne and extracts), antimony trioxide, titanium dioxide, silica (crystalline), di(2-ethylhexyl) phthalate, ethylene thiourea, acrylonitrile, 1,3-butadiene, epichlorohydrin, toluenediisocyanate, tetrafluoroethylene, ethylbenzene, formaldehyde, furfuryl alcohol, glass fibers, methyl isobutyl ketone, nickel (metallic and compounds), lead and lead compounds which are known to the State of California to cause cancer; and 1,3-butadiene, epichlorohydrin, di(2-ethylhexyl)phthalate, di-isodecyl phthalate, ethylene thiourea, methyl isobutyl ketone, methanol, toluene, lead and lead compounds which are known to the State of California to cause birth defects and other reproductive harm. For more information go to www.P65Warnings.ca.gov.

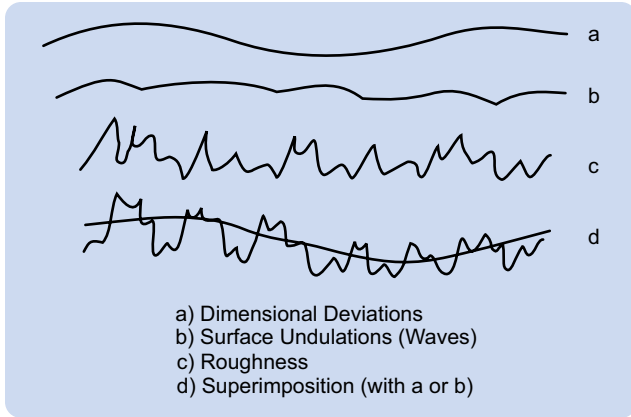

Figure 5-3: Surface Finish Structure

This is given in Figure 5-4 by the roughest profile Z_4 . In this case $Z_4 = R_{max}$ does not include extreme roughness peaks as is the case of R_t .

The medium roughness value R_a is an arithmetic mean of all components of the roughness trace within the trace length l_m . The average roughness value R_z of five consecutive trace lengths often is preferred to R_c .

If R_a is known, R_z can be taken from Figure 5-5 and vice versa. Figure 5-5 is taken from DIN 4768, part 1, attachment 1. Should R_z reach the upper portion of the graph, it can be assumed that the specified R_a values will not be exceeded.

The lower limits would be taken if an R_z value should be specified.

Finally, the depth of roughness R_p also is of interest and is the vertical distance between the highest point on the roughness trace and the center line of that trace.

Values for R_t are of very little assistance in reaching a conclusion regarding the suitability of a surface roughness from the sealing point of view. Table 5-1 shows that for a similar R_t all levels of roughness can be produced. R_a values are unsuitable for comparison because profiles 6 and 7 have the same R_a value. R_p values without reference to the load area t_p also gives a false impression of roughness.

A static sealing surface $R_t \leq 6.3 \mu\text{m}$ (VVV roughness DIN 3141) is rougher than the dynamic surface requirements. Seal manufacturers recommend a roughness $R_t \leq 2.5 \mu\text{m}$ for a dynamic sealing surface ($R_a = 0.25$ to 0.5 mm) (VVV roughness DIN 3141) when the load area is over 50%, or when the surface finish roughness R_p is under 50%. These limitations often are overlooked, nevertheless the connection between surface finish and load area is very important because an "open" profile can have sharp edges (e.g., profiles 2 through 6 in Table 5-2). These open profiles are a product of cutting processes such as turning or grinding. A much larger load area is produced by cold forming processes such as rolling, drawing or sinking.

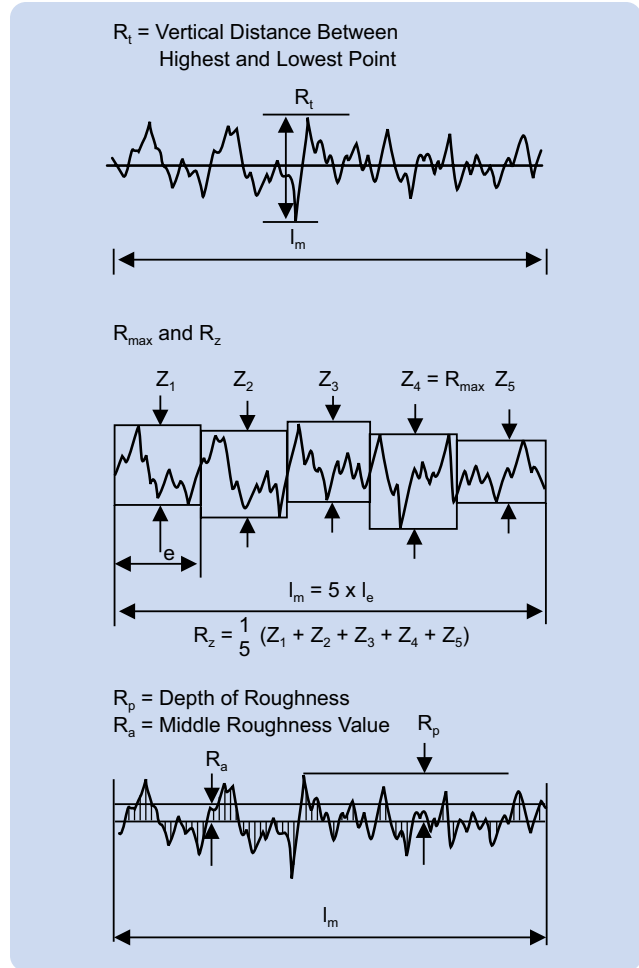

Figure 5-4: Roughness Terminology

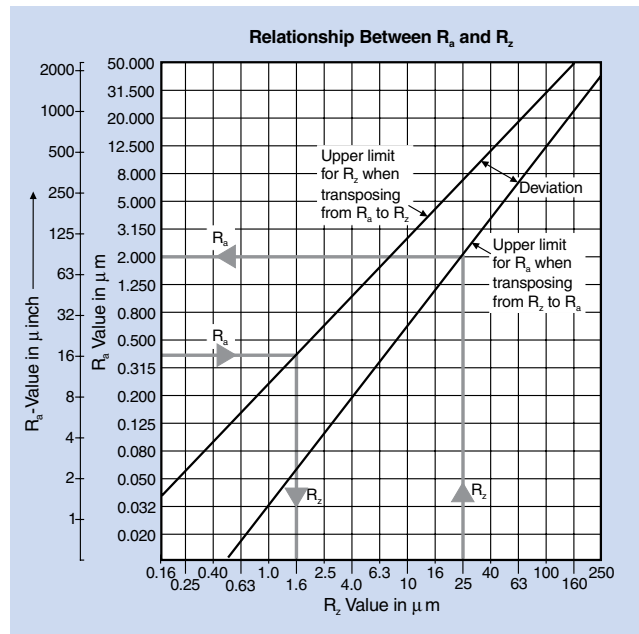

Figure 5-5: Relationship Between R_a and R_z

WARNING: These products can expose you to chemicals including carbon black (airborne and extracts), antimony trioxide, titanium dioxide, silica (crystalline), di(2-ethylhexyl) phthalate, ethylene thiourea, acrylonitrile, 1,3-butadiene, epichlorohydrin, toluenediisocyanate, tetrafluoroethylene, ethylbenzene, formaldehyde, furfuryl alcohol, glass fibers, methyl isobutyl ketone, nickel (metallic and compounds), lead and lead compounds which are known to the State of California to cause cancer; and 1,3-butadiene, epichlorohydrin, di(2-ethylhexyl)phthalate, di-isodecyl phthalate, ethylene thiourea, methyl isobutyl ketone, methanol, toluene, lead and lead compounds which are known to the State of California to cause birth defects and other reproductive harm. For more information go to www.P65Warnings.ca.gov.

It can be clearly seen from Figure 5-6 that surfaces produced by roller burnishing have no sharp peaks which can cause damage to a seal. Further, the valleys form potential lubrication reservoirs which improve the dynamic behavior of a seal.

Surface finish values obtained in a single test are possibly not typical. For this reason several readings should be taken. When several results are to be compared, the length of the test surface must be stated — for different trace lengths, results are not comparable because they result from other profile heights.

5.4 Temperature Effects On Dynamic Seals

High Temperatures — It should be remembered that the higher the temperature (above 38°C) (100°F) in and around a reciprocating gland, the more critical the application becomes. The higher the interface temperature, the greater the tendency of the lighter fractions of the oil to evaporate from an exposed surface. Lack of lubrication will cause greatly accelerated seal wear. If the temperature is high enough, the tacky residue (resins) which remains after oil evaporation will char and create a hard, abrasive surface which, if not removed, will quickly abrade away the seal until leakage or complete seal failure occurs.

Low temperatures — Low temperature environments are most troublesome, especially if the seal has been operating at a high temperature for some time. This is because the elastomer in the seal will take a compression set at high temperature. When the seal is then subjected to low temperature, there may be insufficient elastic memory to overcome the relatively high coefficient of shrinkage (10 times that of steel) at low temperatures.

Once unseated from a spot on a given metal surface, the seal must be resealed by internal seal resilience or system pressure. Therefore, it is much easier to seal a hydraulic system that goes from zero-pressure to high-pressure almost instantaneously. Low-pressure fuel, pneumatic, oil, and similar fluid systems are prone to leak if an O-ring is used as a dynamic seal at -54°C (-65°F) because there is insufficient pressure to keep the O-ring tightly seated during and immediately after motion of the gland. Remember that the -54°C (-65°F) compound is flexible and capable of acceptable seal performance at -54°C (-65°F) but may not be resilient below -43°C (-45°F).

5.5 Side Loads

Side loads on a piston or rod can cause the clearance in the gland to be on one side only. If excess clearance is created by side-loading, extrusion will result. If adequate squeeze has not been applied, leakage will result. The higher unit load on the opposite side causes uneven friction on the seal, and if high enough, the rod or barrel will be galled or scored.

5.6 Direction of Pressure

The placement of a groove can be determined from the direction of the system pressure in relation to the direction of the moving friction force. If the friction of the moving metal surface across the O-ring is in the same direction as the direction of pressure, the O-ring will tend to be dragged into the gap more readily and thus extrude at only 30 to 40% of the pressure normally necessary to cause extrusion. By placing the groove in the opposite metal part, any friction will work against pressure. Snubbing cylinders, in which the motion and force create the pressure, are the usual culprits.

5.7 Shock Loads and Pressures

Shock pressures, such as those created by the sudden stopping of a rapidly descending hydraulic hoist cylinder on which there is a heavy load, are often far in excess of the pressure for which the seal and the system were designed. The same could be said about the whip of a gun barrel, of a tank on rough roads, or a truck tailgate and others if they are designed

	R_t	R_p	R_a	t_p (%)		
				0.25	0.50	0.75
1.	1	0.5	0.5	50	50	50
2.	1	0.5	0.5	50	50	75
3.	1	0.5	0.5	50	50	75
4.	1	0.75	0.28	12.5	25	37.5
5.	1	0.25	0.28	62.5	75	87.5
6.	1	0.785	0.188	3.5	14	35
7.	1	0.215	0.188	65	86	96.5
8.	1	0.5	0.39	43	50	57

Table 5-2: Diagrammatic Representation of Surface Profiles

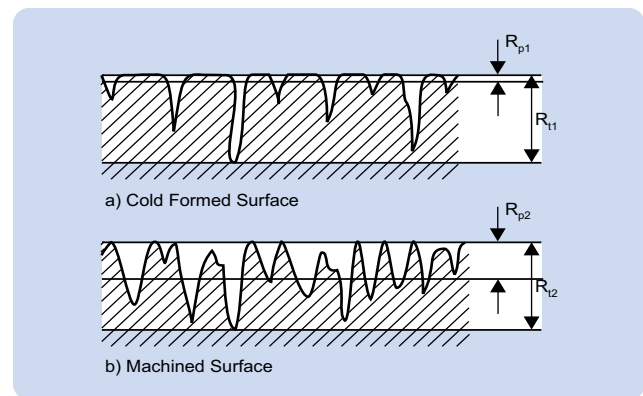

Figure 5-6: Surfaces Produced by Roller Burnishing (a) and by Normal Machining (b)

WARNING: These products can expose you to chemicals including carbon black (airborne and extracts), antimony trioxide, titanium dioxide, silica (crystalline), di(2-ethylhexyl) phthalate, ethylene thiourea, acrylonitrile, 1,3-butadiene, epichlorohydrin, toluenediisocyanate, tetrafluoroethylene, ethylbenzene, formaldehyde, furfuryl alcohol, glass fibers, methyl isobutyl ketone, nickel (metallic and compounds), lead and lead compounds which are known to the State of California to cause cancer; and 1,3-butadiene, epichlorohydrin, di(2-ethylhexyl)phthalate, di-isodecyl phthalate, ethylene thiourea, methyl isobutyl ketone, methanol, toluene, lead and lead compounds which are known to the State of California to cause birth defects and other reproductive harm. For more information go to www.P65Warnings.ca.gov.

to ride on the hydraulic system during transit. Transient pressures of 690 Bar (10,000 psi) are not uncommon in these cases. A mechanical lock or brake should be provided to hold a position once it is attained. The hydraulic cylinder should be used only to raise and lower the load if it does not have a relief valve within it to prevent excessive pressure build-up by shock loads.

5.8 High Frequency Motion or Vibration

O-rings or other seals can be worn excessively by small frequent motions which are usually encountered when equipment is in transit. For example: the tilt cylinder of a lift truck, a hydraulic tailgate lift, and a road scraper blade. Normally, the hydraulic cylinder is intended as an actuator and not as a locking device or a snubber. It will be noted that brick pavements and dirt roads cause the most trouble when this type of effect is encountered. A mechanical lock is also recommended as a cure in this case.

5.9 Squeeze

The best squeeze for a reciprocating O-ring seal must be a compromise of all the factors involved. The design tables in this chapter are generally satisfactory. The greater the temperature range to be sealed, the greater the squeeze that is needed. The same is true if low pressure or vacuums are encountered. On the other hand, too much squeeze will cause excessive friction, wear, and occasionally spiral failure. Some rubber compounds require more squeeze than others in order to seal. The nitrile (buna-N) base compounds are recommended whenever possible because they are more extrusion-resistant, more wear-resistant, and require less squeeze to seal, than any other oil-resistant rubber developed to date.

The military services have found that more than 0.432 mm (0.017") squeeze (per side) on a 5.334 mm (0.210") cross section makes an O-ring prone to spiral failure. Yet much less than this amount of squeeze will allow leakage at low temperature.

As discussed before, the amount of squeeze is a vital factor in friction. Therefore, one should carefully consider the squeeze applied to the O-ring in any gland design.

Squeeze is actually necessary only during periods of very low or no pressure sealing because at high pressures the O-ring seeks the path of least resistance, the clearance gap, and tends to seal tighter and tighter as the pressure is increased.

Enough squeeze must always be provided to offset the great difference in coefficient of shrinkage of the rubber and the metal, take up the tolerances of the metal and rubber parts, and compensate for the shrinkage (if any) of the rubber in the fluid. The following example illustrates how the squeeze can vary in a typical piston installation:

Consider Parker size 2-012 and Design Table 5-2:

1. With perfect concentricity

$$\text{Gland Depth, } L_{\max} = \frac{0.501 - 0.387}{2} = 0.057$$

$$\text{Radial clearance, max} = \frac{0.501 - 0.496}{2} = 0.0025$$

$$\text{Cross section, } W_{\min} = .067$$

$$\text{Reduction of } W, \text{ due to installation stretch} = 0.003 \text{ (see Figure 3-3)}$$

$$W_{\min, \text{ installed}} = 0.064$$

$$\text{less } L_{\max} = 0.057 \text{ (from 1. above)}$$

$$\text{squeeze, min} = 0.007$$
2. With maximum radial displacement (piston tangent with bore)

$$\text{squeeze, min} = 0.007 \text{ (from 1. above)}$$

$$\text{radial piston shift, max} = 0.0025$$

$$\text{squeeze} = 0.0045 \text{ min possible}$$
3. With maximum eccentricity of 0.002 T.I.R. between piston and groove OD

$$\text{squeeze, min} = 0.0045 \text{ (from 2. above)}$$

$$\text{radial piston shift, max} = 0.0010$$

$$\text{squeeze, min.} = 0.0035 \text{ with adverse tolerance build-up.}$$

If the O-ring is made in a compound that will shrink in the fluid, the minimum possible squeeze under adverse conditions then must be at least .076 mm (.003").

5.10 Stretch

When an O-ring must be stretched more than two or three percent as installed in a piston groove, the reduction in the squeeze diameter that results should be allowed for in determining the gland depth so that the desired percent squeeze will be applied to the reduced section. The percent of stretch should therefore be checked whenever the catalog gland dimensions are not used.

Large diameter O-rings may fit the piston so loosely that they must be carefully stuffed into the groove as the piston enters the cylinder to prevent damage. For these, the danger of damage is reduced if the next smaller size O-ring is used. Since this will likely cause a stretch close to five percent, it will usually be necessary to adjust the gland depth as mentioned above. See Figure 3-3 for the reduction in squeeze diameter with stretch.



WARNING: These products can expose you to chemicals including carbon black (airborne and extracts), antimony trioxide, titanium dioxide, silica (crystalline), di(2-ethylhexyl) phthalate, ethylene thiourea, acrylonitrile, 1,3-butadiene, epichlorohydrin, toluenediisocyanate, tetrafluoroethylene, ethylbenzene, formaldehyde, furfuryl alcohol, glass fibers, methyl isobutyl ketone, nickel (metallic and compounds), lead and lead compounds which are known to the State of California to cause cancer; and 1,3-butadiene, epichlorohydrin, di(2-ethylhexyl)phthalate, di-isodecyl phthalate, ethylene thiourea, methyl isobutyl ketone, methanol, toluene, lead and lead compounds which are known to the State of California to cause birth defects and other reproductive harm. For more information go to www.P65Warnings.ca.gov.

5.11 Friction

Friction, either break-out, running, or both, can become troublesome in some applications. At any given time, there are anomalies and difficulties in the prediction of developed friction. These are accentuated if one of the surfaces involved is deformable as in O-ring piston or shaft seals. An understanding of the principles may prove helpful in the solution of specific problems.

5.11.1 Break-Out Friction

In addition to the usual causes of running friction: hardness of the rubber, type of surface, surface finish, squeeze on the O-ring, amount and type of lubrication, fluid pressure/temperature, the amount of break-out friction that a system will generate depends on the length of time the surfaces of the metal and the seal element have been in physical contact at rest. See Figures 5-7 and 5-8.

The theory has been proposed and generally accepted that the increase of friction on standing is caused by the rubber O-ring flowing into the microfine grooves or surface irregularities of the mating part. As a general rule for a 70 durometer rubber against an 8 micro-inch surface, the maximum break-out friction that will develop in a system is 3 times the running friction. This ratio can be reduced by the use of a softer rubber. Table 5-3 shows some of the factors which may be used to adjust friction.

Coefficient of friction has little bearing on lubricated rubber's break-out and running friction. The other variables listed are much more important in the practical solution to problems.

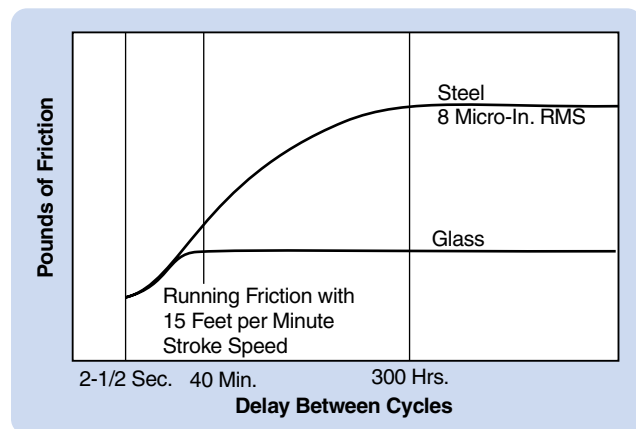

Figure 5-7: Change of O-ring Friction with Time at Rest

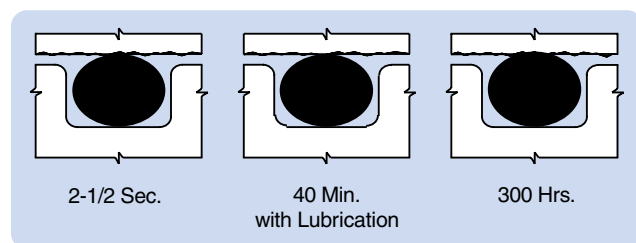

Figure 5-8: Flow of O-Ring into Metallic Surfaces

5.11.2 Running Friction

High running friction may cause difficulty by wearing soft metal parts. Metals such as copper, brass or aluminum can be rapidly worn away by a moving O-ring. This is especially true if high pressures are involved. If unexplained leakage occurs with these or other soft metals, it is good practice to check the metal dimensions for signs of wear.

The following formulas may be used for estimating the running friction of O-rings.

Piston Groove

$$F_C = f_c \times L_p$$

$$F_H = f_h \times A_p$$

$$F = F_C + F_H$$

A_p = Projected area of seal for piston groove applications.

A_r = Projected area of seal for rod groove applications.

F = Total seal friction in pounds.

F_C = Total friction due to seal compression.

F_H = Total friction due to hydraulic pressure on the seal.

f_c = Friction due to O-ring compression obtained from Figure 5-9.

f_h = Friction due to fluid pressure obtained from Figure 5-10.

L_p = Length of seal rubbing surface in inches for piston groove applications.

L_r = Length of seal rubbing surface in inches for rod groove applications.

Rod Groove

$$F_C = f_c \times L_r$$

$$F_H = f_h \times A_r$$

$$F = F_C + F_H$$

Example:

Parker 2-214 rubbing against OD of O-ring at 103.5 Bar (1500 psi), 10% compression, 70 durometer:

$$F_C = 0.7 \times 3.93 = 2.75$$

$$F_H = 48 \times 0.44 = 20.90$$

$$F = F_C + F_H = 23.65 \text{ pounds}$$

Data for the coefficients (f_c and f_h) are given in Figures 5-9 and 5-10. Projected areas and lengths of rubbing surface are given in Table 5-4.

Friction Factors (In Order of Importance)

To Increase Friction	Factor	To Decrease Friction
Increase	Unit Load (squeeze)	Decrease
Increase RMS	Surface Finish (metal)	Decrease RMS
Increase	Durometer	Decrease
Decrease	Speed of Motion	Increase
Increase	Cross Section of O-Ring	Decrease
Increase	Pressure	Decrease
Omit Lubrication	Lubrication	Use Lubrication
Decrease	Temperature	Increase
Decrease	Groove Width	Increase
Increase	Diameter of Bore or Rod	Decrease
Decrease	Surface Finish (O-Ring)	Increase
Stretch O-ring	Joule Effect*	Compress O-Ring
Lower Durometer of O-ring	Coefficient of Friction#	Increase Durometer

* Refer to rotary seals.

A minor factor and should be ignored in design work other than for ultra high speeds.

Table 5-3: Friction Factors



WARNING: These products can expose you to chemicals including carbon black (airborne and extracts), antimony trioxide, titanium dioxide, silica (crystalline), di(2-ethylhexyl) phthalate, ethylene thiourea, acrylonitrile, 1,3-butadiene, epichlorohydrin, toluenediisocyanate, tetrafluoroethylene, ethylbenzene, formaldehyde, furfuryl alcohol, glass fibers, methyl isobutyl ketone, nickel (metallic and compounds), lead and lead compounds which are known to the State of California to cause cancer; and 1,3-butadiene, epichlorohydrin, di(2-ethylhexyl)phthalate, di-isodecyl phthalate, ethylene thiourea, methyl isobutyl ketone, methanol, toluene, lead and lead compounds which are known to the State of California to cause birth defects and other reproductive harm. For more information go to www.P65Warnings.ca.gov.

5.12 Calculate Rubbing Surface

The areas and lengths given in Table 5-4 are based on the dimensions given in Design Table 5-2 at the end of this section. If the application differs, use dimensions from the applicable table, i.e. Table Design 5-1 for aerospace, and calculate the area and length.

The following example illustrates the procedure:

$$\text{Projected Area: } A_p = (\pi / 4) [A_{\max}^2 - (B-1)_{\min}^2]$$

$$A_r = (\pi / 4) [(A-1)_{\max}^2 - B_{\min}^2]$$

$$\text{Rubbing Surface Length: } L_p = \pi A_{\max}$$

$$L_r = \pi B_{\max}$$

For Parker Size No. 2-113: $A_{\max} = 0.751$ $B_{\min} = 0.559$
 $A-1_{\max} = 0.739$ $B-1_{\min} = 0.571$
 $B_{\max} = 0.561$

Projected Area:

$$A_p = (\pi/4) [(0.751)^2 - (0.571)^2] = 0.187 \text{ sq. in.}$$

$$A_r = (\pi/4) [(0.739)^2 - (0.559)^2] = 0.184 \text{ sq. in.}$$

Rubbing Surface Length:

$$L_p = 0.751\pi = 2.36 \text{ in.}$$

$$L_r = 0.561\pi = 1.76 \text{ in.}$$

5.13 Methods To Reduce Friction

The foregoing formulas for estimating O-ring friction are intended for applications in which standard O-ring compound types are to be used in systems lubricated with hydraulic oil. In pneumatic or other dynamic applications, Parker Seal can help reduce friction in several ways. O-Lube and Super-O-Lube greases are available from Parker distributors, and O-rings may be ordered that have received special friction reducing treatments. These include internally lubricated rings and Lube Treated rings.

5.14 Friction and Wear

O-rings load a sealing surface due to their own resilience compounded with any system pressure. When the surface to be sealed moves relative to the O-ring, frictional forces are set up producing two effects: one leads to wear and the other reduces the useful load which a cylinder can transmit.

5.14.1 Friction

In dynamic applications difference must be made between break-out and running friction. Break-out friction must be overcome at the beginning of movement and also is known as start-up friction. Once movement is established the frictional forces drop to a lower level and gliding begins. This can be clearly seen in reciprocating cylinders.

The running friction of seals depends on countless factors making a mathematical analysis practically impossible. For this reason it is difficult to make exact statements regarding the level of friction which can be expected. The most important factors are:

Related to the seal:

- Geometrical form including production tolerances and resulting deformation;
- Hardness and surface finish;
- Friction values for dry and lubricated compound;
- Swell and temperature characteristics.

Related to the hydraulic fluid:

- Tendency to build up a lubricating film and its distribution;
- Viscosity and temperature/viscosity relationship.

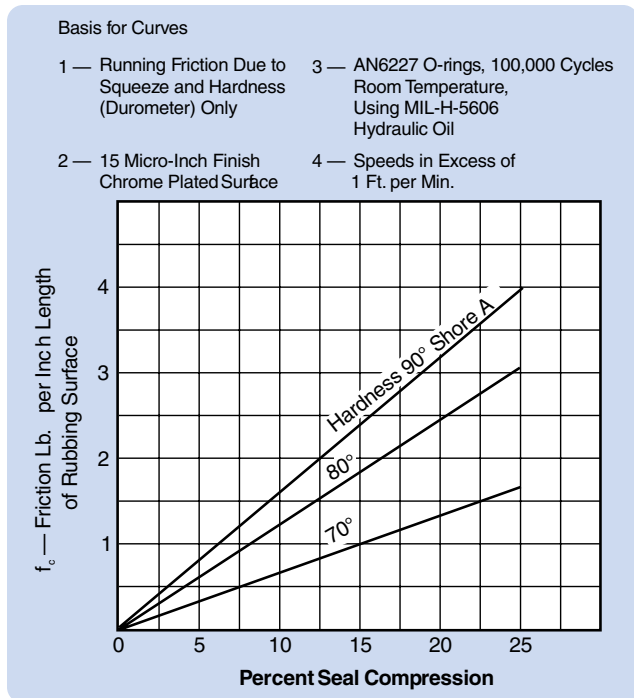

Figure 5-9: Friction Due to O-ring Compression

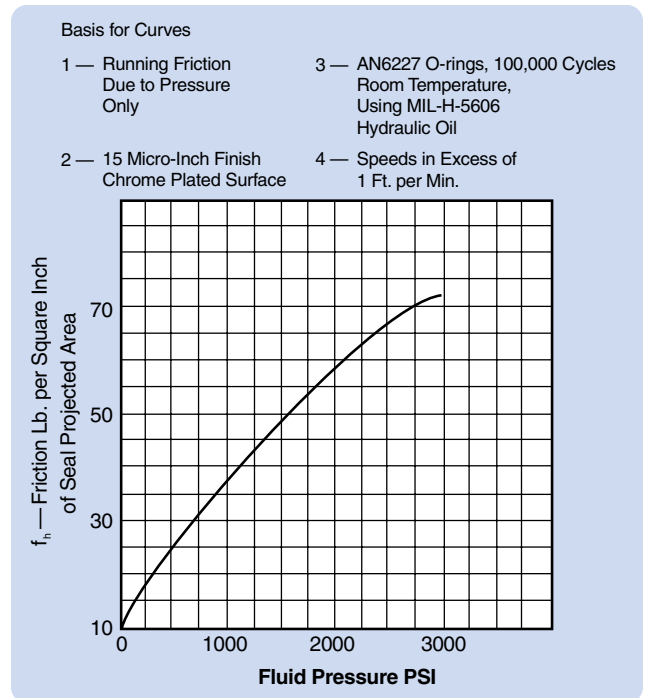

Figure 5-10: Friction Due to Fluid Pressure

WARNING: These products can expose you to chemicals including carbon black (airborne and extracts), antimony trioxide, titanium dioxide, silica (crystalline), di(2-ethylhexyl) phthalate, ethylene thiourea, acrylonitrile, 1,3-butadiene, epichlorohydrin, toluenediisocyanate, tetrafluoroethylene, ethylbenzene, formaldehyde, furfuryl alcohol, glass fibers, methyl isobutyl ketone, nickel (metallic and compounds), lead and lead compounds which are known to the State of California to cause cancer; and 1,3-butadiene, epichlorohydrin, di(2-ethylhexyl)phthalate, di-isodecyl phthalate, ethylene thiourea, methyl isobutyl ketone, methanol, toluene, lead and lead compounds which are known to the State of California to cause birth defects and other reproductive harm. For more information go to www.P65Warnings.ca.gov.

Projected Areas and Lengths of Rubbing Surface for O-Rings

O-Ring Size Parker No. 2-	Piston Groove		Rod Groove		O-Ring Size Parker No. 2-	Piston Groove		Rod Groove	
	A _p Sq. In.	L _p In.	A _r Sq. In.	L _r In.		A _p Sq. In.	L _p In.	A _r Sq. In.	L _r In.
006	.03	.79	.03	.39	215	.46	4.13	.46	3.33
007	.04	.89	.04	.49	216	.48	4.33	.48	3.53
008	.05	.98	.04	.58	217	.51	4.52	.50	3.72
009	.05	1.08	.05	.68	218	.53	4.72	.53	3.92
010	.06	1.18	.05	.78	219	.56	4.91	.55	4.12
011	.07	1.38	.07	.98	220	.58	5.11	.58	4.31
012	.08	1.57	.08	1.17	221	.61	5.31	.60	4.51
013	.09	1.77	.09	1.37	222	.63	5.50	.63	4.71
014	.10	1.97	.10	1.57	325	1.00	5.90	.99	4.71
015	.11	2.16	.11	1.76	326	1.07	6.29	1.07	5.10
016	.12	2.36	.12	1.96	327	1.14	6.68	1.14	5.49
017	.14	2.56	.13	2.16	328	1.22	7.07	1.21	5.88
018	.15	2.75	.14	2.35	329	1.29	7.47	1.29	6.28
019	.16	2.95	.16	2.55	330	1.36	7.86	1.36	6.67
020	.17	3.14	.17	2.75	331	1.44	8.25	1.43	7.06
021	.18	3.34	.18	2.94	332	1.51	8.65	1.51	7.45
022	.19	3.54	.19	3.14	333	1.58	9.04	1.58	7.85
023	.20	3.73	.20	3.33	334	1.66	9.43	1.65	8.24
024	.21	3.93	.21	3.53	335	1.73	9.82	1.73	8.63
025	.22	4.13	.22	3.73	336	1.81	10.22	1.80	9.03
026	.24	4.32	.23	3.92	337	1.88	10.61	1.87	9.42
027	.25	4.52	.24	4.12	338	1.95	11.00	1.95	9.81
028	.26	4.72	.26	4.32	339	2.03	11.40	2.02	10.20
110	.13	1.77	.13	1.17	340	2.10	11.79	2.10	10.59
111	.15	1.97	.15	1.37	341	2.17	12.18	2.17	10.99
112	.17	2.16	.17	1.57	342	2.25	12.58	2.24	11.38
113	.19	2.36	.18	1.76	343	2.32	12.97	2.31	11.77
114	.20	2.56	.20	1.96	344	2.39	13.36	2.39	12.16
115	.22	2.75	.22	2.16	345	2.47	13.75	2.46	12.56
116	.24	2.95	.24	2.35	346	2.54	14.15	2.54	12.95
117	.26	3.14	.25	2.55	347	2.62	14.54	2.61	13.34
118	.28	3.34	.27	2.75	348	2.69	14.93	2.68	13.73
119	.29	3.54	.29	2.94	349	2.76	15.32	2.76	14.13
120	.31	3.73	.31	3.14	425	3.59	15.72	3.57	14.13
121	.33	3.93	.32	3.33	426	3.69	16.11	3.66	14.52
122	.35	4.13	.34	3.53	427	3.78	16.51	3.76	14.91
123	.36	4.32	.36	3.73	428	3.87	16.90	3.85	15.31
124	.38	4.52	.38	3.92	429	3.97	17.29	3.95	15.70
125	.40	4.72	.40	4.12	430	4.06	17.68	4.04	16.09
126	.42	4.91	.41	4.32	431	4.16	18.08	4.14	16.48
127	.43	5.11	.43	4.51	432	4.25	18.47	4.23	16.88
128	.45	5.30	.45	4.71	433	4.35	18.86	4.32	17.27
129	.47	5.50	.47	4.90	434	4.44	19.25	4.42	17.66
130	.49	5.70	.48	5.10	435	4.53	19.65	4.51	18.05
131	.50	5.89	.50	5.30	436	4.63	20.04	4.61	18.45
132	.52	6.09	.52	5.49	437	4.72	20.43	4.70	18.84
133	.54	6.29	.54	5.69	438	4.91	21.22	4.89	19.63
134	.56	6.48	.55	5.89	439	5.10	22.00	5.08	20.41
135	.58	6.68	.57	6.08	440	5.29	22.79	5.27	21.20
136	.59	6.88	.59	6.28	441	5.48	23.57	5.46	21.98
137	.61	7.07	.61	6.47	442	5.67	24.36	5.64	22.77
138	.63	7.27	.63	6.67	443	5.85	25.15	5.83	23.55
139	.65	7.46	.64	6.87	444	6.04	25.93	6.02	24.34
140	.66	7.66	.66	7.07	445	6.23	26.72	6.21	25.12
141	.68	7.86	.68	7.26	446	6.61	28.29	6.59	26.69
142	.70	8.05	.70	7.46	447	6.98	29.86	6.96	28.26
143	.72	8.25	.71	7.65	448	7.36	31.43	7.34	29.84
144	.73	8.45	.73	7.85	449	7.74	33.00	7.72	31.41
145	.75	8.64	.75	8.05	450	8.12	34.57	8.09	32.98
146	.77	8.84	.77	8.24	451	8.49	36.14	8.47	34.55
147	.79	9.04	.78	8.44	452	8.87	37.71	8.85	36.12
148	.80	9.23	.80	8.64	453	9.25	39.28	9.22	37.69
149	.82	9.43	.82	8.83	454	9.62	40.85	9.60	39.26
210	.34	3.15	.34	2.35	455	10.00	42.42	9.98	40.83
211	.36	3.34	.36	2.54	456	10.38	43.99	10.36	42.40
212	.39	3.54	.38	2.74	457	10.75	45.57	10.73	43.97
213	.41	3.74	.41	2.94	458	11.13	47.14	11.11	45.54
214	.44	3.93	.43	3.14	459	11.51	48.71	11.49	47.11
					460	11.89	50.28	11.86	48.69

Table 5-4: Projected Areas and Lengths of Rubbing Surface for O-rings

WARNING: These products can expose you to chemicals including carbon black (airborne and extracts), antimony trioxide, titanium dioxide, silica (crystalline), di(2-ethylhexyl) phthalate, ethylene thiourea, acrylonitrile, 1,3-butadiene, epichlorohydrin, toluenediisocyanate, tetrafluoroethylene, ethylbenzene, formaldehyde, furfuryl alcohol, glass fibers, methyl isobutyl ketone, nickel (metallic and compounds), lead and lead compounds which are known to the State of California to cause cancer; and 1,3-butadiene, epichlorohydrin, di(2-ethylhexyl)phthalate, di-isodecyl phthalate, ethylene thiourea, methyl isobutyl ketone, methanol, toluene, lead and lead compounds which are known to the State of California to cause birth defects and other reproductive harm. For more information go to www.P65Warnings.ca.gov.

Related to the working conditions:

- Working pressure;
- Velocity of movement;
- Type of material and surface finish of surfaces;
- Working tolerances;
- Axial loads and wear bands on pistons.

These factors cannot be quantified because they overlap and act cumulatively.

At the beginning of a stroke the seal goes through three friction phases. Initially the seal is in direct contact with the sealing face with few lubricated fields, e.g., $\mu = 0.3$. Then follows a wider area of mixed friction where the coefficient of friction can drop as low as 0.06 to 0.08 according to the proportion of lubrication/non-lubricated areas (Figure 5-11). Finally, pure hydrodynamic friction which does not allow direct contact between the seal and the running surfaces is rarely reached.

As complete lubrication (= flooding) occurs, loss of fluid from a system increases.

Friction depends on a compound's sliding properties. Hardness and deformation of the seal influence the seal pressure. Specific seal pressure is in general related to, but not strictly proportional, to the system pressure.

The working pressure controls the width of clearance gaps and thereby the thickness of the lubricating film. The result depends on the geometry of the seal. Friction caused by O-rings increases with increasing pressure. Lip seals are more sensitive to pressure, friction increases quicker than with seals without a lip. This shows that the geometry of a seal directly affects the amount of friction.

Friction is proportional to the working pressure and therefore it is necessary to keep seal friction low, especially at low pressures.

Unfortunately, reduction of the sealing force also results in an increased tendency to leakage. This relationship can be modified within certain limits by selection of the seal geometry. Normally the decision must be made between lower friction and high leakage.

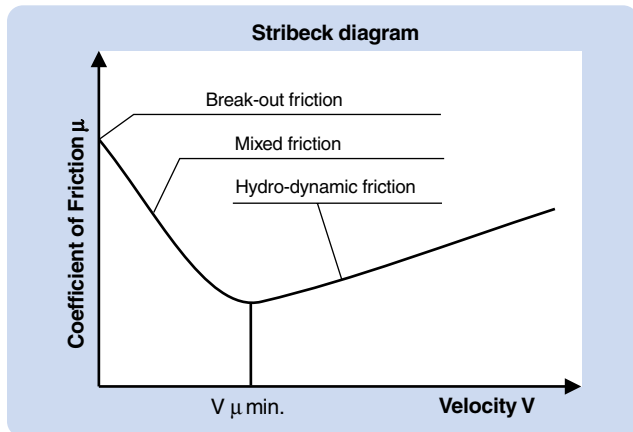

Figure 5-11: Stribeck Diagram

Additionally, an unstable seal geometry due to swelling in the medium plays a role. Swelling means increase sealing force and increased friction.

When the medium is mineral oil it would seem that sufficient lubrication is assured. However, the seal geometry once again plays a role when, for example, a wiper seal scrapes a shaft dry. Leakage at a wiper seal will not occur until the seal wears. On the other hand lubrication can cause leakage amounting to the thick lubricating film with every stroke.

The optimum condition is a relatively thin lubricating film with sufficient adhesive properties.

The dynamic piston actually causes less friction with increasing velocity. In absolute terms there are very large discrepancies according to the thickness of the lubricating film. The reduction of friction with increasing velocity stems from the hydrodynamic properties of the lubricating fluid. This is also true for harder compounds. At low pressures the friction varies to the piston speed. At high pressures friction is seen to be more or less constant.

Friction is directly influenced by the seal diameter because the wear-area is greater. The greater the metal surface roughness, the more the contact surface consists of metallic "islands" and therefore again mixed friction occurs.

As in many other areas break-out friction of elastomers is significantly higher than running friction. Apart from compound type and seal geometry, tendency to adhesion, deformation, the down-time and the surface finish play a role in increasing break-out friction. The longer the down-time, the more lubrication is squeezed from between the seal and the running surface resulting in a non-lubricated vacuum. In this condition the level of starting friction approaches that for dry friction and is up to 10 times that found in running friction (Figures 5-12 and 5-11).

For the same conditions, friction at high temperature (= low viscosity) is high because the lubricating film is often interrupted.

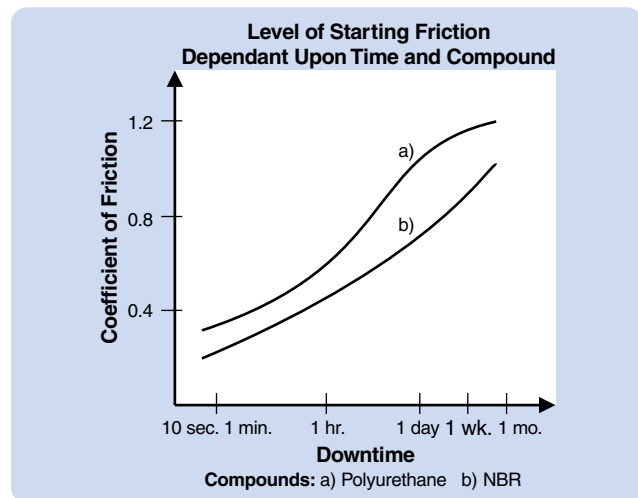

Figure 5-12: Level of Starting Friction Dependant Upon Time and Compound

WARNING: These products can expose you to chemicals including carbon black (airborne and extracts), antimony trioxide, titanium dioxide, silica (crystalline), di(2-ethylhexyl) phthalate, ethylene thiourea, acrylonitrile, 1,3-butadiene, epichlorohydrin, toluenediisocyanate, tetrafluoroethylene, ethylbenzene, formaldehyde, furfuryl alcohol, glass fibers, methyl isobutyl ketone, nickel (metallic and compounds), lead and lead compounds which are known to the State of California to cause cancer; and 1,3-butadiene, epichlorohydrin, di(2-ethylhexyl)phthalate, di-isodecyl phthalate, ethylene thiourea, methyl isobutyl ketone, methanol, toluene, lead and lead compounds which are known to the State of California to cause birth defects and other reproductive harm. For more information go to www.P65Warnings.ca.gov.

The most important factors can be seen in Figure 5-13. Here friction is shown as a function of pressure and velocity. Figure 5-13 is valid only for a specific seal in a particular application. For other seals and applications the interdependence varies.

The stick-slip effect also is related to the friction at the sealing face. The friction, or better expressed the difference between break-out and running friction, plays an important role in evaluation and selection of a suitable elastomer.

Break-out friction occurs when the three following conditions are present:

- When the break-out friction is higher than the running friction a running velocity $V_{\mu \min}$ (see Figure 5-11);
- The running velocity is $V_{\mu \min}$;
- The power is transmitted through the elastic body of the “compressible” oil.

To assist in the explanation of the term stick-slip, please refer to Figure 5-14. To accelerate a mass m from zero to maximum velocity, the break-out friction μH must be overcome by $F1$. The spring element is loaded with $F1$ and with increasing velocity the friction value μH reduces to μG and the force to $F2$. The potential energy stored in the spring accelerates the mass even further. When the stored energy is used, the mass is decelerated by the increasing friction in direction μH . This requires once again an increase in force level of $F1$, and the procedure repeats again.

Running velocity is a product of seal friction, the piston mass and the load. Of all these factors, only friction can be influenced and makes for a better relationship between sealing

surface finish, lubricating film and surface finish. Certain improvements can be made making the system stiffer, this means the smallest possible oil volume under pressure on the hydraulic side.

Radial oscillation of the piston will occur when the lubricating film breaks down. Conversely oils with strong film building properties do not break down under the same working conditions using the same seals.

5.14.2 Pneumatic Seals

In principle the same conditions apply here as for the hydraulic seal, except that the effects of certain extreme conditions are more serious. This is particularly the case when lubrication is poor, as found when lubricated air is not available. Lubricated air gives more or less the same results as in a hydraulic application.

When lubricating grease is not continually replaced, it can eventually be removed by a seal lip. The effectiveness of lubrication with grease depends on the thickness of the original film and the running velocity of the seal (Figure 5-15).

The lower the velocity the thinner will become the lubricating film. With an O-ring seal the loss of grease can lead to total breakdown of the hydrodynamic lubricating film after only a few slow strokes.

Breakdown of the lubricating film after long operation also results in contact between the seal and the metal surfaces. This makes the seal move in the mixed friction range, the increase in friction causes high wear. The lubricating film therefore must be protected by rounding of the seal wiper edges and complete wiping of grease from the running surface must be prevented.

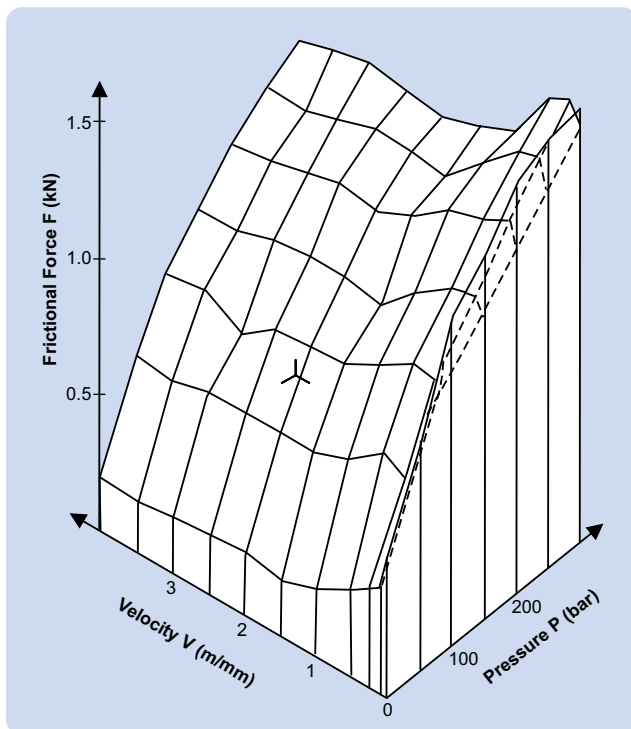

Figure 5-13: Frictional Force is Dependent Upon Pressure and Velocity – Compact Rod Seal 90° Shore A

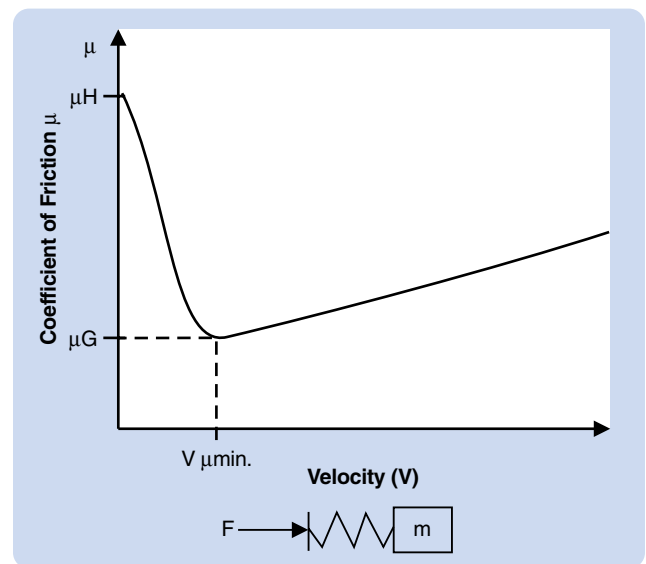

Figure 5-14: System Diagram for Stick-Slip Effect

WARNING: These products can expose you to chemicals including carbon black (airborne and extracts), antimony trioxide, titanium dioxide, silica (crystalline), di(2-ethylhexyl) phthalate, ethylene thiourea, acrylonitrile, 1,3-butadiene, epichlorohydrin, toluenediisocyanate, tetrafluoroethylene, ethylbenzene, formaldehyde, furfuryl alcohol, glass fibers, methyl isobutyl ketone, nickel (metallic and compounds), lead and lead compounds which are known to the State of California to cause cancer; and 1,3-butadiene, epichlorohydrin, di(2-ethylhexyl)phthalate, di-isodecyl phthalate, ethylene thiourea, methyl isobutyl ketone, methanol, toluene, lead and lead compounds which are known to the State of California to cause birth defects and other reproductive harm. For more information go to www.P65Warnings.ca.gov.

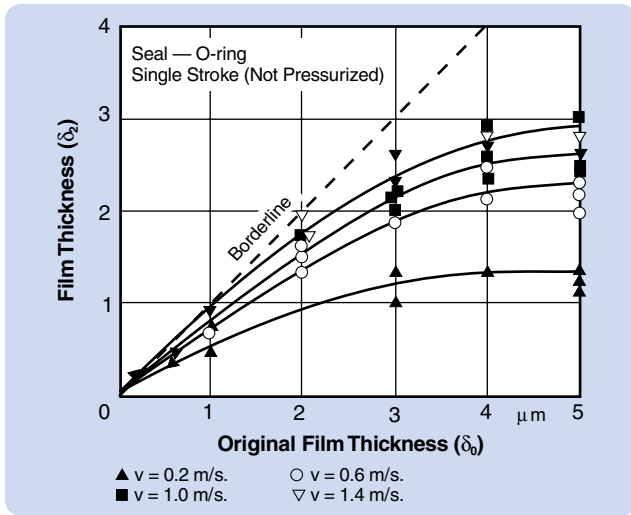

Figure 5-15: Change in Original Film Thickness as a Function of Running Speed During a Single Stroke (Border Line Δ Theoretical maximum Values)

This action has little effect upon the starting friction but brings a noticeable improvement in running friction levels.

If slow pneumatic piston velocities are achieved by throttling the pressurizing air, the risk of high stick-slip increases. Stick-slip is effected directly and negatively by long seal lips and sharp seal edges. An extremely rough or fine polished metallic running surface both cause equally higher stick-slip.

5.14.3 Wear

Friction causes wear. However, friction can be anticipated and taken into consideration in the design stage. The wear rate however is difficult to predict but directly governs the lifetime of an O-ring and the frequency of maintenance.

Today's high precision machinery tends in most cases to eliminate hydrodynamic lubrication because of the increased wipe-off effect. This means the seal always functions in semidry condition and for this reason wear resistance depends on:

- properties of the compound;
- lubricating properties of the medium;
- running surface roughness;
- working conditions.

Wear in fluid solutions can be divided into four groups:

- Scuff wear develops with metal-to-metal contact in the semidry condition where both materials tend to form mixed crystals. High Performance Lubricating (HPL) oils help to prevent this contact because of their additives. These additives have no influence in rubber/steel or rubber/metal combinations.
- Fatigue wear becomes evident when particles are released from the metal structure and is usually the result of pulsating loads.

- Corrosion wear manifests itself in the form of rust and can normally be reduced by suitable oil additives. Seals are not directly affected by the above types of wear. However, in dynamic applications particularly these wear conditions can cause the seal to fail through abrasion.
- Abrasive wear can affect both metallic and seal areas. Metals are abraded by hard compounds or by hard foreign matter in the medium. A rough metal surface normally is the cause of elastomer abrasion.

The seal user normally has no profound knowledge of seal wear characteristics. It is therefore recommended to consult the manufacturer about details of all extreme application conditions so that the correct seal can be offered.

5.14.4 Interdependence of Friction Wear and an Effective Seal

In order to obtain a problem-free seal it is necessary to have stability with regard to the clearance gap to avoid possible extrusion. However, stability is difficult to achieve because the relevant parameters often work conversely.

The first consideration is the lubricating film in the clearance gap. To estimate friction, lifetime and leakage it is necessary to know the width of the gap and how it varies under working conditions. To keep friction as low as possible the lubricating film should be fairly substantial. This, however, can result in leakage because the "thick" film is wiped off the rod surface during the return stroke. In the other extreme a lack of lubricating film causes problems due to high friction. The effectiveness of a seal and friction therefore are inversely proportional.

Hardness, together with the width and length of a clearance gap is very important. The hardness determines the elasticity of the seal and assures that the seal gives way to the lubricating film under pressure. The instantaneous viscosity of the fluid also plays an important role in resisting the wiping effect of the seal.

It is still not known which factors influence the lubricating film and which mechanisms act in the clearance gap. A soft compound favors a thicker film. Hard and soft compounds behave differently at high velocities, harder compounds help form a lubricating film whereas a soft compound will hinder this by strong adhesion to the running surface.

The lubricating film is very important but only one of the factors affecting seal friction. Other factors are, for example, the seal compound, seal shape, pressure, velocity, and changes in direction. Often many of these factors are difficult to measure or reproduce.

It is therefore quite understandable that seal manufacturers cannot give customers fixed figures regarding friction and wear for an individual seal. Information about seal lifetimes only can be made when all parameters affecting the seal are known and reproducible. General assumptions from a few tests are not acceptable because laboratory tests never can reproduce real working situations.



WARNING: These products can expose you to chemicals including carbon black (airborne and extracts), antimony trioxide, titanium dioxide, silica (crystalline), di(2-ethylhexyl) phthalate, ethylene thiourea, acrylonitrile, 1,3-butadiene, epichlorohydrin, toluenediisocyanate, tetrafluoroethylene, ethylbenzene, formaldehyde, furfuryl alcohol, glass fibers, methyl isobutyl ketone, nickel (metallic and compounds), lead and lead compounds which are known to the State of California to cause cancer; and 1,3-butadiene, epichlorohydrin, di(2-ethylhexyl)phthalate, di-isodecyl phthalate, ethylene thiourea, methyl isobutyl ketone, methanol, toluene, lead and lead compounds which are known to the State of California to cause birth defects and other reproductive harm. For more information go to www.P65Warnings.ca.gov.

5.15 Spiral Failure

A unique type of failure sometimes occurs on reciprocating O-rings which is called spiral failure. This name was given to this type of failure because when it occurs the seal looks as if it had been cut about halfway through the O-ring cross section in a spiral or corkscrew pattern. Oddly enough, the O-ring usually seals satisfactorily until a complete break or separation occurs at one place. Sometimes the seal is twisted in two without evidence of the spiral pattern, but in general, the same factors cause the break.

A properly used O-ring slides during all but a small fraction of any reciprocating stroke. This type of seal does not normally tend to roll or twist because:

1. The hydraulic pressure, acting through the O-ring, produces a greater holding force within the groove (friction on a larger area) than that produced by the sliding surface (rod or cylinder wall) opposite the groove (see Figure 5-16).
2. The smoother finish of the sliding surface, in relation to the groove surface-finish, produces less friction.
3. Running friction is lower than break-out friction.
4. The torsional resistance of the O-ring tends to resist twisting.

The conditions which cause spiral failure are those that simultaneously cause segments of the ring to slide and others to roll. A small amount of twisting is not detrimental but, when excessive, torsional failure or spiral failure will occur. True spiral failure occurs after the seal has been excessively twisted, but not broken, and then subjected to relatively high

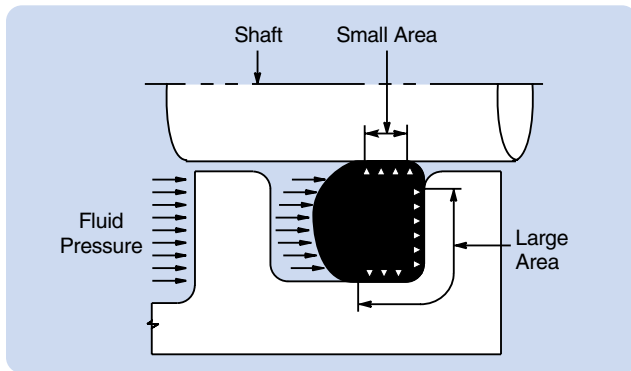

Figure 5-16: Action of Fluid Pressure to Prevent Rolling of O-ring

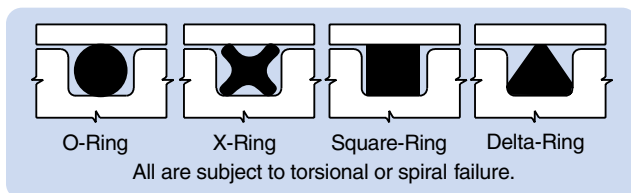

Figure 5-17: Ring Cross-Sections for Reciprocating Seals

pressure. The twisted seal is forced into the sharp corner at the clearance gap by the pressure which puts an additional stress on this portion of the seal. Rapid stress-aging, or stress above the elastic limit of the rubber, causes a rupture of the O-ring to start adjacent to the clearance gap. Slight flexing, motion, or working of the O-ring apparently causes the rupture to penetrate about half way through the cross section. When the O-ring is removed from the gland, it returns to its original shape and the rupture appears as a tight spiral around the cross section.

Torsional or spiral failure is not limited to the O-ring or torus type of seal. Square, delta, four-leaf clover, and other cross sectional shapes (see Figure 5-17) are also prone to fail by twisting if the proper conditions exist.

The design and operational factors which contribute to spiral failure of a seal are listed below in the order of their relative importance:

1. Speed of stroke
2. Lack of lubrication
3. Pressure differential and direction
4. Squeeze
5. Shape of groove or split grooves
6. Temperature of operation
7. Length of stroke
8. Surface finish of gland
9. Type of metal surface
10. Side loads
11. ID to W ratio of O-ring
12. Contamination or gummy deposits on metal surface
13. Type of metal rubbing surface
14. Breathing
15. Concentricity of mating metal parts
16. Stretch of O-ring (see rotary shaft seals)
17. Lack of back-up rings
18. Poor installation of O-rings

Only the very important or less obvious factors which contribute to spiral failure will be discussed. Some of those which have been discussed elsewhere will also be omitted here. It should be remembered that before spiral failure can occur, an O-ring must be twisted by one or more of the above inter-related factors. Usually, several factors combine to produce any failure that develops. Some of the other seal designs will leak excessively when twisted. The O-ring usually seals until complete failure occurs.

WARNING: These products can expose you to chemicals including carbon black (airborne and extracts), antimony trioxide, titanium dioxide, silica (crystalline), di(2-ethylhexyl) phthalate, ethylene thiourea, acrylonitrile, 1,3-butadiene, epichlorohydrin, toluenediisocyanate, tetrafluoroethylene, ethylbenzene, formaldehyde, furfuryl alcohol, glass fibers, methyl isobutyl ketone, nickel (metallic and compounds), lead and lead compounds which are known to the State of California to cause cancer; and 1,3-butadiene, epichlorohydrin, di(2-ethylhexyl)phthalate, di-isodecyl phthalate, ethylene thiourea, methyl isobutyl ketone, methanol, toluene, lead and lead compounds which are known to the State of California to cause birth defects and other reproductive harm. For more information go to www.P65Warnings.ca.gov.

5.15.1 Speed of Stroke

Investigations have disclosed that one of the primary causes of spiral failure is by reciprocating speeds of less than one foot per minute. It appears that at this slow speed, the sliding or running seal friction created is very high and comparable to break-out friction. Extreme twisting will occur on low or balanced pressure components, such as hydraulic accumulators, in a relatively few (about 200) cycles if the temperature is above 39°C (100°F). O-ring seals are not recommended, therefore, for speeds less than one foot per minute when the pressure differential is less than 27.6 Bar (400 psi). If the system pressure is slowly lost, as through slow valve leaks, and a sealed piston moves slowly through a cylinder a number of times, spiral failure of the O-ring very probably will result. The obvious remedy here is to provide good maintenance of the system so that slow leaks are prevented, or make it an operational practice to quickly exhaust the system after the day's work.

5.15.2 Lack of Lubrication

The lack of lubrication on a surface exposed to the atmosphere is one of the prime contributors to spiral failure. Excessive wear will normally occur. However, twisting of the seal and spiral failure can result if the unlubricated surface is actuated through the seal with little or no pressure on the seal to hold it and prevent it from rolling. This applies primarily to long stroke (greater than 152.4 mm (6")) applications.

The remedy for this situation is to:

- Use lubricating (or lubricated) wiper rings.
- Apply a suitable grease, that will not evaporate, to the exposed surface.
- Use a fluid that will not tend to evaporate or become tacky at the operating temperature.
- Lubricate metal surface prior to assembly.
- Use a metal or surface plating that will produce less friction.

5.15.3 Pressure Differential and Direction

As explained earlier, the direction of pressure and seal friction should oppose each other. Spiral failure is more likely to occur if the pressure and seal friction are both in the same direction. In other words, seals in a pump are more likely to spiral than are those in an actuator.

Normally an O-ring will not twist when the pressure differential across the seal is greater than 27.6 Bar (400 psi) during operation.

5.15.4 Squeeze

The aerospace industry has generally found that more than 0.043 mm (0.017 in.) of squeeze on the side of a 5.3 mm (0.210") cross section (W) O-ring will make some long stroke applications prone to spiral failure. It can be easily seen that more rolling force is created on the cross section with an increase in squeeze. Other factors are normally involved when failure occurs with the standard squeezes recommended for reciprocating seals.

5.15.5 Shape of Groove and Split Groove

If a V-shaped groove is used, it is evident that the hydraulic holding force is reduced because the area on the side of the V-groove is less than at the bottom and side of a square groove. V-grooves are much more prone to produce spiral failures. This is especially true if any of the other factors are out of balance. Split grooves give trouble if the hydraulic holding force on the O-ring against both the side and the bottom of the groove is not maintained. Great care should be used when designing glands which have an opening in the bottom in order to make sure the normal holding force will be maintained (see Figure 5-16).

5.15.6 Temperature of Operation

When the temperature in and around a system is substantially increased, the seals are more prone to fail. This is because lubricants are more likely to evaporate, or lose their, "light ends", and/or lose some of their lubricity, the seal becomes softer, the squeeze is increased due to the rubber expansion, and the metal clearances may become greater.

5.15.7 Length of Stroke

As a general rule, the longer the stroke of a cylinder or rod, the greater the eccentricity, bending, side load, and other factors that contribute to wear and/or spiral failure. We do not recommend an O-ring for service when the stroke is greater than 304.8 mm (12") unless extra precautions are taken to avoid trouble.

5.15.8 Surface Finish

When a cylinder or rod is actuated, side loads, bending, chips or other foreign material, and non perfect machining, drilling and finishing all in some way tend to contribute to scoring, galling, marring, or scratching of the surface over which the seal must slide (refer to metals and floating glands). When this occurs, the roughness is unevenly distributed around the circumference or periphery. Even though it may be very slight, it creates an uneven friction condition and thus can contribute to spiral failure and/or uneven, excessive wear.

5.15.9 Back-Up Rings

Back-up rings sometimes provide enough extra lubrication on the return stroke to assist in the prevention of spiral failure. For further information see the discussion on back-up rings in Section VI.

5.16 Modifications for Special Applications

Normally, the gland dimensions given in Design Tables 5-1 and 5-2 are adequate and give trouble-free service. If not applicable, the following modifications will help solve specific problems:

- Small Amount of Leakage
- Early Stress-Aging
- Low Temperature Leakage
- Excessive Swells (above 20%)



WARNING: These products can expose you to chemicals including carbon black (airborne and extracts), antimony trioxide, titanium dioxide, silica (crystalline), di(2-ethylhexyl) phthalate, ethylene thiourea, acrylonitrile, 1,3-butadiene, epichlorohydrin, toluenediisocyanate, tetrafluoroethylene, ethylbenzene, formaldehyde, furfuryl alcohol, glass fibers, methyl isobutyl ketone, nickel (metallic and compounds), lead and lead compounds which are known to the State of California to cause cancer; and 1,3-butadiene, epichlorohydrin, di(2-ethylhexyl)phthalate, di-isodecyl phthalate, ethylene thiourea, methyl isobutyl ketone, methanol, toluene, lead and lead compounds which are known to the State of California to cause birth defects and other reproductive harm. For more information go to www.P65Warnings.ca.gov.

5.16.1 Small Amount of Leakage

1. Examine the O-ring for signs of cutting during installation.
2. Increase the squeeze on the cross-section of O-ring.
3. Reduce the groove length. A wide groove may cause leakage because of pumping action of the O-ring. This is especially possible when the piston is cycled rapidly.
4. Improve the surface finish of metal rubbing surface.
5. Check for eccentric machining of gland.

5.16.2 Early Stress-Aging

1. Redesign groove to reduce stretch of the O-ring.
2. Redesign groove to reduce squeeze of the O-ring.
3. Use a more heat-resistant rubber compound.
4. Make certain O-ring is not being twisted during dry assembly.
5. Use larger O-ring to reduce stretch.
6. Make sure O-rings are not closer than six feet from an electric motor (operating) during shelf storage. Ozone causes rapid deterioration of most elastomers.

5.16.3 Low Temperature Leakage

1. Make certain that O-ring compound was designed for operation at low temperatures.
2. Increase squeeze of the O-ring. Coefficient of contraction of rubber is about 10 times that of steel and several times greater than aluminum.
3. Spring load the O-ring (see Figure 3-1).
4. Make sure all gland surfaces are smooth enough (see paragraph 5.3).

Note: Minute leakage is to be expected and is in fact, desirable, when an O-ring is used as a reciprocating seal. An O-ring that does not by-pass a little fluid at each stroke is running dry and high friction and rapid seal wear will result.

5.16.4 Excessive Swell (above 20%)

1. Replace O-ring with one made from a compound more resistant to the fluid being sealed.
2. Increase groove length. If the volume of the groove is too small, increased friction and excessive stress may cause premature failure of the O-ring (refer to discussions of friction and spiral failure).

5.17 Gland Dimensions for Reciprocating Hydraulic O-Ring Seals

For most reciprocating applications in which an O-ring is sealing a liquid of any kind (the design is not limited to hydraulic oils), the dimensions of either Design Table 5-1, the military design, or Design Table 5-2, the industrial design, would be suitable. Of the two, Parker Seal Group normally recommends the Table 5-2 dimensions because these industrial designs, in most cases, allow for the use of standard drill rod

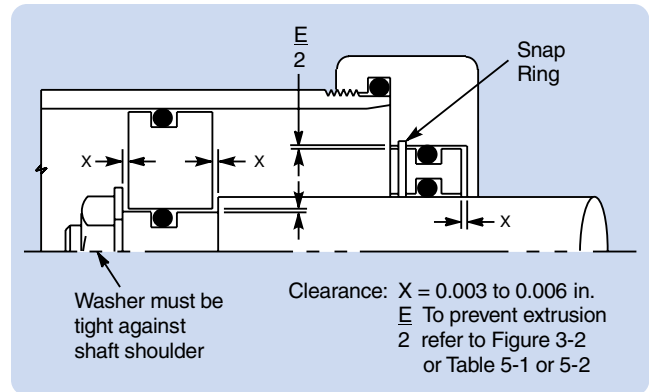

Figure 5-18: Floating Gland

sizes and standard boring tools. The dimensions in this table are actually in good agreement with early versions of the aerospace table. The military dimensions cause less stretch on the O-rings. The percent reduction is so slight, except in the smallest sizes, that the effect cannot be significant, while the cost of the special machined rods and boring tools that are required could be high.

In reciprocating applications for which neither table applies because of a predetermined dimension that does not agree, the following procedure may be used to find gland dimensions.

1. For piston seals, select an O-ring having an OD near to or preferably slightly larger than the cylinder bore diameter.
2. For rod seals, select on O-ring having an ID closest to the rod diameter. It may be slightly larger or smaller, but ID stretch should not exceed 5% as installed for optimum design.
3. In all reciprocating seals, make sure minimum squeeze recommendations are considered.

5.18 Floating Glands

Since it is impossible to bore, drill or tap perfect, true holes, and to machine perfect parts providing perfect alignment, the engineer should consider the floating gland. Eccentricity (lack of concentricity) is allowable, but it does cause high unit loads on small portions of bearing surfaces. In turn, this causes minute scratches on the metal surface on which the O-ring must rub (with the possible exception of very soft bearing materials, such as babbitt).

In order to reduce or eliminate the high bearing loads, the relatively inexpensive floating gland should be used whenever possible. The object of this gland is to allow the piston or rod bearing (containing the O-ring groove), to pivot, adjust, or float a small amount, offsetting misalignment. (See Figure 5-18.)

This gland design increases the life of the O-ring and eliminates many of the spasmodic or unscheduled failures, as well as reducing the maintenance cost.

WARNING: These products can expose you to chemicals including carbon black (airborne and extracts), antimony trioxide, titanium dioxide, silica (crystalline), di(2-ethylhexyl) phthalate, ethylene thiourea, acrylonitrile, 1,3-butadiene, epichlorohydrin, toluenediisocyanate, tetrafluoroethylene, ethylbenzene, formaldehyde, furfuryl alcohol, glass fibers, methyl isobutyl ketone, nickel (metallic and compounds), lead and lead compounds which are known to the State of California to cause cancer; and 1,3-butadiene, epichlorohydrin, di(2-ethylhexyl)phthalate, di-isodecyl phthalate, ethylene thiourea, methyl isobutyl ketone, methanol, toluene, lead and lead compounds which are known to the State of California to cause birth defects and other reproductive harm. For more information go to www.P65Warnings.ca.gov.

5.19 Pneumatic Reciprocating O-Ring Seals

The past few years have shown a rapid increase of interest in pneumatic systems, not only for new equipment, but as a replacement for some existing hydraulic components. Some of the more general reasons are:

1. Increased non-flammability.
2. Light weight.
3. Leakage is less critical and does not contaminate the surrounding area.
4. The atmosphere acts as a giant reservoir.
5. System fluid is not decomposed by high temperature.

5.20 Temperature

Nitrile rubber is generally the first compound considered for a seal. It should be remembered, however, that it is less resistant to dry heat than it is to hot oils or other liquids. Nitrile compounds are used for pneumatic applications more than any other polymer, but in this kind of use, temperatures are usually low. In pneumatic applications above 104°C (220°F) for extended periods of time, consider ethylene propylene, fluorocarbon, or even silicone or fluorosilicone. The choice depends on temperature extremes, internal lubricant, severity of service, and overall cost.

5.21 Silicone Compounds

If silicone compounds are used, extra attention is necessary to make sure that all foreign material and sharp edges or corners are removed from the gland. This is necessary because of the relatively poor resistance to cutting and abrasion which is characteristic of silicone compounds. Recent developments have improved the abrasion resistance and oil resistance of the silicones, but they are still far short of many other synthetic rubbers.

5.22 High-Pressure

The most difficult gland to seal for any type of packing is that in a high-pressure pneumatic system because, in addition to the problems encountered with liquids, the following must be considered:

1. It is the hardest type seal to keep lubricated.
2. Oxygen in the air comes in direct contact with the seal and causes rapid aging and/or deterioration. This problem is amplified as system pressures and temperatures increase. (More oxygen is present due to the compression of the air.)

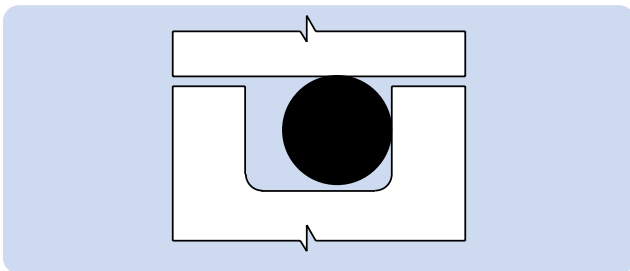

Figure 5-19: Floating O-Ring Seal

3. Gaseous molecules are very small, and will pass into and through (permeate) materials and openings which liquids will not. (See Table 3-19.)
4. The large change in volume which a gas undergoes with fluctuations in pressure often make necessary very special rubber seal materials so gases that have entered the seal can be rapidly expelled. Otherwise, blisters, ruptures, and chunks will be blown out of the seal when decompression of the system occurs. All organic materials are permeable, so the gas cannot be kept out of the seal.
5. Compounds other than those used in hydraulic systems are often necessary because the requirements are entirely different. This is especially true at high temperatures above 71°C (160°F) and high pressure (69 Bar to 207 Bar) (1000 psi to 3000 psi).

5.23 Lubrication

Most conventional pneumatic applications that fail prematurely do so because of inadequate lubrication. Rubber has an inherently high coefficient of friction with all metals and most non-metallic surfaces. Disregarding the necessity for lubrication will result in high friction, excessive abrasion or rapid wear of the rubber O-ring and heat build-up. For pneumatic seal applications it is especially important that adequate lubrication be provided. Of course, a lubricant must be selected that will not cause deterioration of the O-ring.

5.24 Gland Dimensions

Normally, the static and reciprocating gland dimensions given at the end of the Static Seals section and this section are adequate and give trouble-free pneumatic service. Much lower squeeze designs are permissible and used frequently in low pressure pneumatic applications (i.e. using shop air pressure for machine tools, holding devices, and similar applications.)

Since the temperature range is very moderate and a little leakage is not critical, some liberties can be taken with soft metals, surface finish and other design criteria without seriously reducing the life expectancy of this type of seal (low pressure cases). In fact, successful designs are in service which vary between the relatively high-squeeze hydraulic gland recommendations and the no-squeeze floating seal design discussed below. Each application seems to have an optimum design depending on what is desired.

5.25 Floating Seal

It has been found possible to modify the standard gland design for moving seals and reduce breakout friction as much as 60%. By allowing the O-ring to float, the frictional forces are greatly reduced and longer life can be expected from the seal. (See Figure 5-19.) There is a slight increase in leakage at the beginning of a stroke which for most pneumatic applications is undetectable. Because of this leakage and other considerations, the design is recommended for a temperature range from -23°C to 82°C (-10°F to 180°F) and for low pressure (up to 13.8 Bar (200 psi)) air service only.



WARNING: These products can expose you to chemicals including carbon black (airborne and extracts), antimony trioxide, titanium dioxide, silica (crystalline), di(2-ethylhexyl) phthalate, ethylene thiourea, acrylonitrile, 1,3-butadiene, epichlorohydrin, toluenediisocyanate, tetrafluoroethylene, ethylbenzene, formaldehyde, furfuryl alcohol, glass fibers, methyl isobutyl ketone, nickel (metallic and compounds), lead and lead compounds which are known to the State of California to cause cancer; and 1,3-butadiene, epichlorohydrin, di(2-ethylhexyl)phthalate, di-isodecyl phthalate, ethylene thiourea, methyl isobutyl ketone, methanol, toluene, lead and lead compounds which are known to the State of California to cause birth defects and other reproductive harm. For more information go to www.P65Warnings.ca.gov.

Recommended dimensions for floating pneumatic piston seal glands are tabulated in Design Chart 5-3 and Design Table 5-3 at the end of this section. The “floating” feature of this design is the virtual lack of squeeze on the O-ring cross-section. Sealing is accomplished by the peripheral squeeze applied to the outside diameter of the O-ring as it is assembled into the bore, and air pressure moving the ring into facial contact with the wall of the groove.

When this principle is understood, it will be seen that when the direction of pressurized air is reversed, a puff of air escapes between the inside diameter of the O-ring and the bottom of the groove during the small fraction of a second it takes the O-ring to move to the other side of the gland. This is the primary reason for the slight increase in leakage mentioned for this design.

The floating seal will not trap pressure between two O-rings in separate grooves unless considerable rubber swell is encountered.

Five or six O-rings are used in adjoining floating seal glands. This design has been used for some hot water and steam applications as a method of increasing O-ring life. The full effect of the hot steam is brought to bear on the inner rings and a lesser amount on the outer rings. Consequently, the seal is effective long after a single O-ring would have failed.

For the design of pneumatic reciprocating rod seals, use Design Chart 5-2 and Design Table 5-2. This is the cross section squeeze design used for hydraulic piston and rod seals. Floating seals are not recommended for pneumatic rods, as they would require stretching the O-ring, causing early aging. Furthermore, since pneumatically actuated shafts often move rapidly, a stretched O-ring in this situation would be subject to the Gow-Joule effect described in the rotary seal discussion. For static pneumatic seal designs, use Design Chart 4-1 and Design Table 4-1.

5.26 Uni-Directional Gland

This design modification utilizes a uni-directional floating seal groove and more than one O-ring (see Figure 5-20). The addition of drilled holes in the grooves causes each O-ring to seal in one direction only, preventing a pressure trap of non-compressible liquid between the O-rings. When using this design, the gland dimensions given in Design Table 5-3 are suggested and the holes should be drilled into the pressure side of the outside grooves on the piston and the inside of the

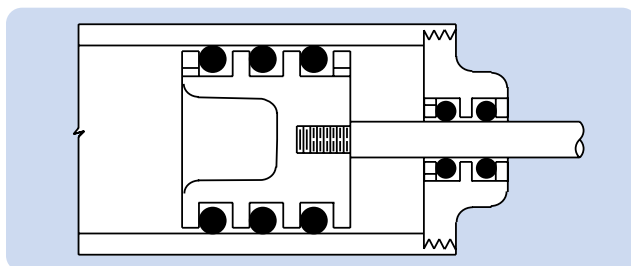

Figure 5-20: Use of Multiple O-Rings in a Floating O-Ring Design

rod glands. As many individual seals as required may be used as long as each groove is vented. The O-rings on either end, alternately seal and release trapped pressure. The three piston O-rings and the two rod O-rings are never all sealing at the same time. The vents are not necessary in pneumatic designs.

5.27 Rotary Seal

An O-ring has proved to be a practical rotary shaft seal in many applications. With the correct design, Parker O-Ring rotary seal compound N1090-85, will provide satisfactory service at surface speeds up to 1500 feet per minute.

The design conditions are most critical for rotary seals, as would be expected. Relatively high durometer compounds, close control of tolerances, and minimum cross section are required.

Rotary seals usually should not be used at temperatures below -40°C (-40°F) even though flexibility to -54°C (-65°F) is claimed, since thermal shrinkage and loss of resilience tend to cause loss of contact with the shaft. In some cases, initial leakage of frozen seals may be tolerable until heat build-up occurs in higher speed shafts. Spring loading may be helpful in some situations.

High-speed shafts of soft metal should be avoided since they will normally wear more rapidly than the rubber, opening the clearance and allowing leakage. Hardened steel shafts in the range of 55 Rockwell are desirable, but not mandatory. Attention to clearances, side thrust, and end-play are critical in designing effective rotary O-ring seals.

Whenever it can be avoided, an O-ring should not be installed in a gland that holds it in more than a minimum of tensional stress. This principle is especially important to consider when designing for an O-ring rotary shaft seal. Most elastomers when heated in the stressed, or stretched condition will contract. This is of practical importance in a rotary seal because it results in a tendency for the O-ring to seize the high-speed rotating shaft. This phenomenon, known as the Gow-Joule effect, occurs only if the rubber is under tensile stress.

The friction between the O-ring and the rotating shaft creates heat. When it is installed in more than a minimum of tensional stress, the O-ring tends to contract when heated and seize the high speed rotating shaft. This contraction causes more friction which in turn causes more heat and the process becomes self-perpetuating, until the O-ring is destroyed.

Even at low surface speeds, where heating is not a problem, a stretched O-ring tends to rotate with the shaft and leak. For speeds below 200 feet per minute, the squeeze recommended in Design Chart 5-2 may be used. However, the shaft diameter should be no larger than the free state ID of the O-ring.

Shaft seal applications where the O-ring is installed in a groove in the shaft are not recommended if the shaft rotates. This is due to the centrifugal action which causes the O-ring to rotate and rub on all surfaces which generally causes early seal leakage or failure.

WARNING: These products can expose you to chemicals including carbon black (airborne and extracts), antimony trioxide, titanium dioxide, silica (crystalline), di(2-ethylhexyl) phthalate, ethylene thiourea, acrylonitrile, 1,3-butadiene, epichlorohydrin, toluenediisocyanate, tetrafluoroethylene, ethylbenzene, formaldehyde, furfuryl alcohol, glass fibers, methyl isobutyl ketone, nickel (metallic and compounds), lead and lead compounds which are known to the State of California to cause cancer; and 1,3-butadiene, epichlorohydrin, di(2-ethylhexyl)phthalate, di-isodecyl phthalate, ethylene thiourea, methyl isobutyl ketone, methanol, toluene, lead and lead compounds which are known to the State of California to cause birth defects and other reproductive harm. For more information go to www.P65Warnings.ca.gov.

O-Ring Sections for Rotary Seals

Speed (fpm*)	Maximum Recommended "W" Dimension
0 to 200	Usually not critical (Use chart 5-2)
200 to 400	0.139
200 to 600	0.103
200 to 1500	0.070

*Feet per minute = 0.26 X Shaft Diameter (inches) X rpm.

Table 5-5: O-Ring Sections for Rotary Seals

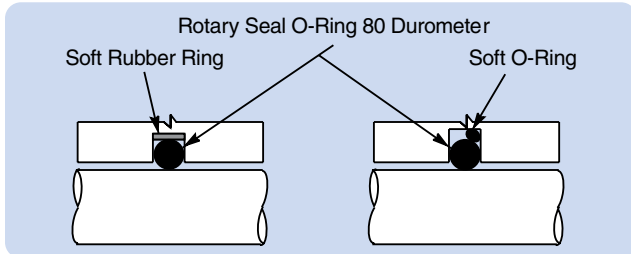

Figure 5-21: Spring-Loading for Rotary Seal

The use of O-rings as high speed rotary shaft seals is usually not recommended for applications requiring lower than -40°C (-40°F) or higher than 121°C (250°F) operating temperatures.

The O-ring gland in a rotary shaft application should not be used as a bearing surface. The shaft should be contained by bearings that will permit the O-ring to operate under the lowest possible heat and load. Because of the limited interference that must be used to avoid frictional heat, the O-ring will not compensate for shafts that are out of round or rotate eccentrically. Shafts should remain concentric within .013 mm (0.0005") T.I.R.

Bearings of all types cause considerable local heat and seals placed too close to them will fail prematurely.

Provision should be made for the dissipation of any heat that may be generated because of friction. The nearer to room temperature the seal interface, the longer the O-ring will seal. There are two methods commonly used to prevent high bearing heat build-up:

Preferred: Provide a clearance of 0.203 mm (0.008") on a side between the rotating shaft and the O-ring housing. Make sure that the shaft does not rub the housing. For pressures exceeding 55.2 Bar (800 psi), decrease the diametrical clearance per Figure 3-2.

Alternate: The bearing length should be at least 10 times the "W" dimension of the O-ring used. This provides for a greater area for heat transfer. If the clearance must be kept to a minimum to prevent high pressure extrusion, the 10 times "W" rule also applies. A floating gland (see Figure 5-18) is preferred to avoid high unit load at a local point or area.

Experience has proven that it is desirable to use the O-ring with the smallest "W", or cross-section diameter, available for the ID required. It is recommended that a "W" dimension of 0.103 be considered maximum for all speeds over 600 feet per minute. (See Table 5-5.)

All metals and plastics suitable for the housing or gland construction of seal assemblies requiring rotary shaft seals can be used with O-rings. However, since most rotary seal compounds contain graphite as a compound ingredient, any metal, such as stainless steel, or surface treatment that may be adversely affected by this material should be avoided.

To ensure maximum O-ring life, use an O-ring compound that has been specially developed for rotary seal applications and provides the required characteristics that are necessary

Problem: To design a rotary seal gland for a 76.2 mm (3") (desired) shaft running at 1750 RPM with oil pressure at 6.9 Bar (100 psi).

Procedural Steps:	Example:
(A) Calculate surface speed.	(A) Speed = 0.26 X 3 X 1750 = 1365 fpm
(B) Determine O-ring cross section that may be used from Table 5-5.	(B) .070 (larger cross sections are eliminated due to speed)
(C) Select .070 cross section O-ring with actual ID closest to desired shaft OD from Design Table 5-4.	(C) Parker No. 2-041
(D) Add 0.002 to O-ring ID to determine max. actual shaft OD, B.	(D) B max. = 2.969 + 0.002 = 2.991 (TOL: + .000, - .001)
(E) Determine gland depth, L from Design Chart 5-4.	(E) 0.065 to 0.067
(F) Calculate Gland Groove ID, A-1 A-1 min. = B max. + 2L min. A-1 max. = B min. + 2L max.	(F) A-1 min. = 2.991 + 2(0.065) = 3.121 A-1 max. = 2.990 + (0.067) = 3.124 A-1 = 3.121 (TOL: + .003, - .000)
(G) Determine diametral clearance, E from Design Chart 5-4.	(G) 0.012 + 0.016
(H) Calculate shaft bore D D min. = B max. + E min. D max. = B min. + E max.	(H) D min. = 2.991 + 0.012 = 3.003 D max. = 2.990 + 0.016 = 3.006 D = 3.003 (TOL: + .003, -.000)
(I) Determine groove width, G from Design Chart 5-4.	(I) 0.075 - 0.079
(J) Check Figure 3-2 to make sure design is extrusion safe.	

Table 5-6: Rotary Seal Design Example

WARNING: These products can expose you to chemicals including carbon black (airborne and extracts), antimony trioxide, titanium dioxide, silica (crystalline), di(2-ethylhexyl) phthalate, ethylene thiourea, acrylonitrile, 1,3-butadiene, epichlorohydrin, toluenediisocyanate, tetrafluoroethylene, ethylbenzene, formaldehyde, furfuryl alcohol, glass fibers, methyl isobutyl ketone, nickel (metallic and compounds), lead and lead compounds which are known to the State of California to cause cancer; and 1,3-butadiene, epichlorohydrin, di(2-ethylhexyl)phthalate, di-isodecyl phthalate, ethylene thiourea, methyl isobutyl ketone, methanol, toluene, lead and lead compounds which are known to the State of California to cause birth defects and other reproductive harm. For more information go to www.P65Warnings.ca.gov.

for this service. See Section II, Basic O-Ring Elastomers, for more information on rotary seal compounds.

Figure 5-21 shows two methods of “spring loading” the hard rotary seal. Either of these should only be used when absolutely necessary to obtain the desired seal.

See Table 5-6 for a rotary seal design example.

5.28 Oscillating Seal

In this guide, two types of oscillating seals are considered:

1. Faucet or valve stems are excellent examples of assemblies that can be simplified by the use of an O-ring seal. Compression type or multiple-lip packing can be eliminated, reducing space requirements and eliminating the need for adjusting or take-up devices. For applications of this type, if the speed is under 200 feet per minute, use Design Table 5-2 for selecting O-ring sizes and gland dimensions.
2. Constantly oscillating shafts, such as those used on timing and metering devices, can be sealed satisfactorily with O-rings. If the motion is continuous for long periods of time, use Design Table 5-4 for O-ring sizes and gland dimensions.

5.29 Seat Seals

A properly designed check or poppet type valve, with an O-ring on the seat, will give an exceptionally long, non-leaking service. Many designers and engineers make the costly mistake of trying to use a conventional groove (square or rectangular) design to hold the O-ring.

With this type of groove, “blow-out” will normally occur when the valve is unseated.

“Blow-out” is a type of seal failure caused by the action of the pressure in the system on the side of the O-ring, forcing it out of the groove into some other part of the valve or system. “Blow-out” usually occurs at differential pressures above 5.5 Bar (80 psi). The exact pressure will depend on the gas or fluid, valve design and the physical properties of the O-ring when a non-retaining or conventional type groove is used.

It should be kept in mind that blow-out is similar to extrusion, but that it occurs at considerably lower pressures.

Figure 5-22 shows an O-ring on the seat of a check valve in a conventional groove. The seal is satisfactory as long as the valve is not opened at or near the pressure necessary to cause blow-out.

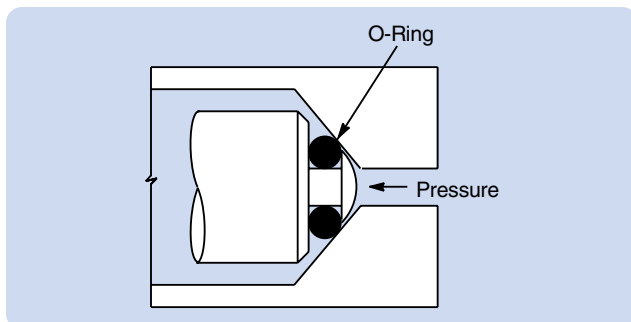

Figure 5-22: Valve Seat Seal, Standard Groove

Figure 5-23 illustrates a valve opening above “blow-out” pressure. As the valve opens, the space between the two faces becomes increasingly larger. The pressure opening the valve is also acting on the O-ring, causing it to continue to seal the opening until it is stretched completely out of the groove and is blown out or forced into another part of the system.

Gases such as air, LPG, CO₂, etc. enter or permeate the O-ring. With release of pressure, the gas inside the O-ring can cause the seal to “balloon” or swell momentarily. (The amount depends on the pressure.) The ballooning effect that can occur at very low pressure usually pops the O-ring out of the groove the same as blow-out. “Ballooning” and “blow-out” often combine to cause valve seal failure. Another term often used to describe this phenomenon is “explosive decompression.” O-ring blow-out may be prevented by using a groove design which encloses more than 180° of the O-ring cross section or by venting the groove. Typical methods used are shown in Figure 5-24. If a rectangular groove must be used, alter the dimensions as follows:

Groove depth — 0.015 to 0.025 less than O-ring cross section diameter.

Groove width — 1.00 to 1.10 times the O-ring cross section diameter.

Groove side angle — 0°, if possible.

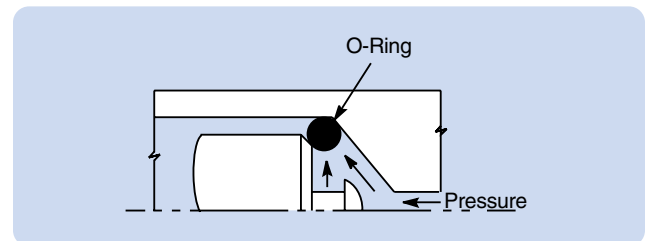

Figure 5-23: O-Ring Blow-Out, Standard Groove

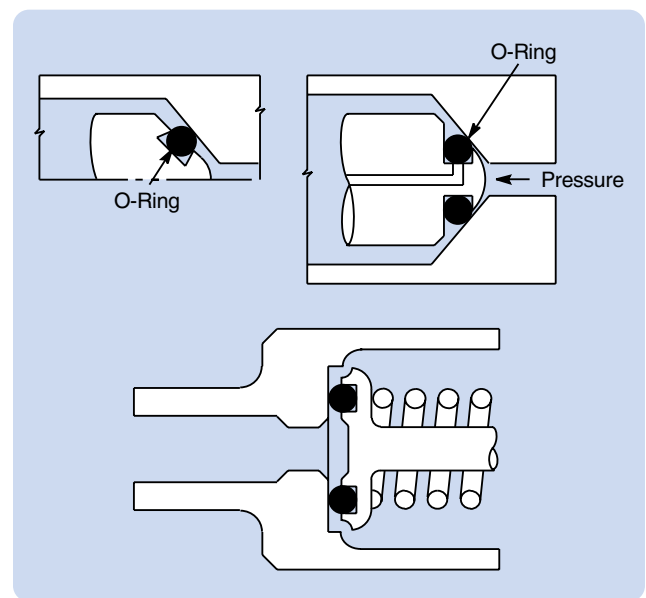

Figure 5-24: Groove Designs to Prevent Blow-Out

WARNING: These products can expose you to chemicals including carbon black (airborne and extracts), antimony trioxide, titanium dioxide, silica (crystalline), di(2-ethylhexyl) phthalate, ethylene thiourea, acrylonitrile, 1,3-butadiene, epichlorohydrin, toluenediisocyanate, tetrafluoroethylene, ethylbenzene, formaldehyde, furfuryl alcohol, glass fibers, methyl isobutyl ketone, nickel (metallic and compounds), lead and lead compounds which are known to the State of California to cause cancer, and 1,3-butadiene, epichlorohydrin, di(2-ethylhexyl)phthalate, di-isodecyl phthalate, ethylene thiourea, methyl isobutyl ketone, methanol, toluene, lead and lead compounds which are known to the State of California to cause birth defects and other reproductive harm. For more information go to www.P65Warnings.ca.gov.

5.30 Drive Belts

O-rings can be used as low power transmission elements. They are not only an economic solution but also offer many advantages:

- Simple installation
- Constant tension
- Flexible fitting
- Because of their elastic properties, O-ring compounds require no adjustment,
- Freely available in standard compounds and sizes
- Greatest possible tolerances in positioning of pulleys.

An O-ring compound is selected for minimum stretch relaxation (tensile set) and maximum dynamic properties. The choice of elastomer is made to the environment:

- Contact medium, e.g. ozone, oil grease,
- Extreme temperatures

The general requirements are:

- Good aging resistance
- Wear resistance
- Relatively low tendency to return to original shape under tension and temperature caused by friction; this means a higher resistance to the Joule effect;
- Good bending flexibility

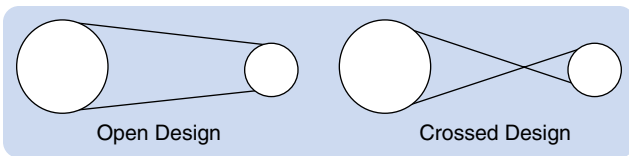

Compound Selection

Please see Section III, paragraph 3.17 for information about drive belt compound selection

Design Information

- Direct contact with fluids should be avoided. For contact medium see medium Compatibility Table.
- The smaller pulley minimum diameter is $D_2 \text{ mm} = 6 \times d_2$ (cross section).
- The elongation of the O-ring inner diameter d_1 is a maximum of 15% (average elongation between 8% and 12%).
- Tension when fitted approximately 0.6 to 1.0 N/mm².
- Cross section d_2 should be greater or equal to 2,62mm.

Ordering Detail

All O-rings which are used as drive belts are subject to additional quality inspection procedures and inspection for surface defects under elongation. O-rings ordered for this application are to be coded as follows: "E0540 DBA2-250".

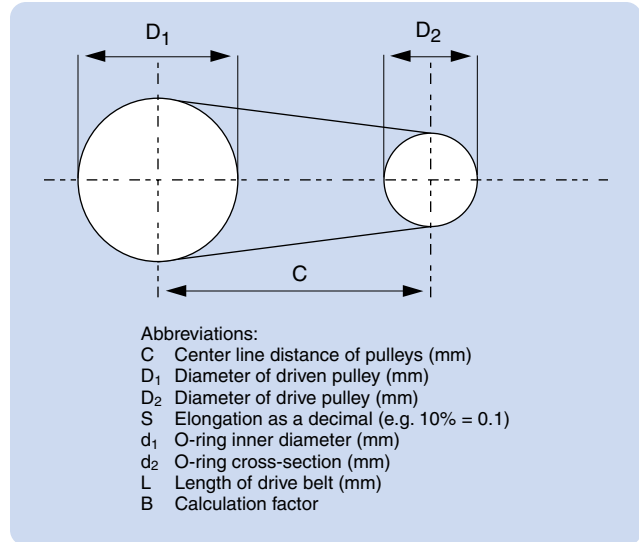

5.30.1 Calculation of Drive Belt Open Design

1. Calculation of O-Ring size d_1 :

Known – D_1 and D_2 , diameter of pulley
 C center line distance of pulleys
 S elongation as a decimal (e.g. 10% = 0.1)

a) Calculation of drive belt L:

$$L = 2 \times C + 1.57 \times (D_1 + D_2) + \frac{(D_1 + D_2)^2}{4 \times C}$$

b) Calculation of O-ring inside diameter d_1 :

$$d_1 = \frac{L}{3.14 \times (1.0 + S)}$$

c) O-rings selected according to the O-ring size list. If a size is required between the sizes then the smaller size should be taken.

2. Calculation of elongation S:

Known – d_1 inside diameter of O-ring
 C center line distance of pulleys
 D_1 and D_2 , diameter of pulleys

a) Calculation of drive belt L: (see above, 1a)

b) Calculation of elongation S as a decimal:

$$S = \frac{L}{3.14 \times d_1} - 1$$

3. Calculation of center line distance C of pulley:

Known – d_1 inside diameter of O-ring
 S elongation as a decimal (e.g. 10% = 0.10)
 D_1 and D_2 , diameters of pulleys

a) Calculation of factor B:

$$B = 3.14 \times d_1 \times (S + 1) - 1.57 \times (D_1 + D_2)$$

b) Thereafter calculation of center line distance C:

$$C = \frac{B + \sqrt{B^2 - (D_1 - D_2)^2}}{4}$$



WARNING: These products can expose you to chemicals including carbon black (airborne and extracts), antimony trioxide, titanium dioxide, silica (crystalline), di(2-ethylhexyl) phthalate, ethylene thiourea, acrylonitrile, 1,3-butadiene, epichlorohydrin, toluenediisocyanate, tetrafluoroethylene, ethylbenzene, formaldehyde, furfuryl alcohol, glass fibers, methyl isobutyl ketone, nickel (metallic and compounds), lead and lead compounds which are known to the State of California to cause cancer; and 1,3-butadiene, epichlorohydrin, di(2-ethylhexyl)phthalate, di-isodecyl phthalate, ethylene thiourea, methyl isobutyl ketone, methanol, toluene, lead and lead compounds which are known to the State of California to cause birth defects and other reproductive harm. For more information go to www.P65Warnings.ca.gov.

5.30.2 Calculation of Drive Belt Crossed Design

1) Calculation of O-Ring size d_1 :

Known – D_1 and D_2 , diameter of pulley

C center line distance of pulleys

S elongation as a decimal (e.g. 10% = 0.1)

a) Calculation of drive belt L :

$$L = \frac{2 \times C + 1.57 \times (D_1 + D_2) + (D_1 - D_2)^2}{4 \times C}$$

b.) Calculation of O-Ring inside diameter d_1 :

$$d_1 = \frac{L}{3.14 \times (1.0 + S)}$$

c) O-ring is selected according to the O-Ring size list. If a size is required between the sizes then the smaller size should be taken.

2) Calculation of elongation S :

Known - d_1 inside diameter of O-Ring

C center line distance of pulleys

D_1 and D_2 , diameter of pulleys

a) Calculation of drive belt L : (see above, 1a)

b) Calculation of elongation S as a decimal:

$$S = \frac{L}{3.14 \times d_1} - 1$$

3. Calculation of center line distance C of pulley:

Known – d_1 inside diameter of O-ring

S elongation as a decimal (e.g. 10% = 0.10)

D_1 and D_2 , diameters of pulleys

a) Calculation of factor B :

$$B = 3.14 \times d_1 \times (S + 1) - 1.57 \times (D_1 + D_2)$$

b) Thereafter calculation of center line distance C :

$$C = \frac{B + \sqrt{B^2 - (D_1 - D_2)^2}}{4}$$

d_2 in mm	r_1 in mm
2.62	1.25 + 0.1
3.53	1.70 + 0.1
5.33	2.60 + 0.1
6.99	3.50 + 0.15

For other cross-sections
 $r_1 = 0.49 \times d_2$
 Surface roughness:
 $R_{max} < 6.3 \mu m$
 $R_a < 1.6 \mu m$

Pulley gland radius

5.31 O-Ring Glands

5.31.1 O-Ring Glands (Per SAE AS4716) for Aerospace Hydraulic (Reciprocating) Packings and Gaskets

Design Chart 5-1 provides the basis for calculating gland dimensions for standard O-ring sizes. These dimensions have been calculated and are listed in Design Table 5-1. The procedures for the use of Design Table 5-1 are outlined in Design Guide 5-1.

After selecting gland dimension, read horizontally to determine proper O-ring size number per AS568A.

There are a number of various O-ring gland design specifications in use throughout industry. These include Aerospace Recommended Practice (ARP) 1232, 1233 and 1234. There also is the International Standards Organization (better known as ISO) Specification 3601/2. Each of these and other less accepted documents have slight dimensional variations from those found in this Handbook.

Guide For Design Table 5-1

If Desired Dimension is Known for	Select Closest Dimension in Column	Read Horizontally in Column	To Determine Dimension for
Cylinder Bore or Male Gland Cylinder Bore I.D.	A	G	Groove Width*
		C	Piston or Cylinder O.D.
		F	Groove O.D.
Piston or Cylinder O.D.	C	G	Groove Width*
		A	Cylinder Bore or Male Gland
		F	Cylinder Bore I.D. Groove O.D.
Rod or Gland Sleeve O.D.	B	G	Groove Width*
		J	Groove I.D.
		H	Rod Bore or Female Gland Housing Bore I.D.
Rod Bore or Female Gland Housing Bore I.D.	H	G	Groove Width*
		J	Groove I.D.
		B	Rod or Gland Sleeve O.D.

*For information on groove width refer to Design Chart 5-1A

Design Guide 5-1: Guide For Design Chart 5-1

WARNING: These products can expose you to chemicals including carbon black (airborne and extracts), antimony trioxide, titanium dioxide, silica (crystalline), di(2-ethylhexyl) phthalate, ethylene thiourea, acrylonitrile, 1,3-butadiene, epichlorohydrin, toluenediisocyanate, tetrafluoroethylene, ethylbenzene, formaldehyde, furfuryl alcohol, glass fibers, methyl isobutyl ketone, nickel (metallic and compounds), lead and lead compounds which are known to the State of California to cause cancer; and 1,3-butadiene, epichlorohydrin, di(2-ethylhexyl)phthalate, di-isodecyl phthalate, ethylene thiourea, methyl isobutyl ketone, methanol, toluene, lead and lead compounds which are known to the State of California to cause birth defects and other reproductive harm. For more information go to www.P65Warnings.ca.gov.

Gland Design, O-Ring and Other Elastomeric Seals (SAE AS4716)
 Standard Gland Width for Zero, One, and Two Backup Rings

Gland and AS568 Dash Number	O-ring Cross Section W		Gland Width G No Backup Ring		Gland Width G One Backup Ring		Gland Width G Two Backup Rings	
	Min.	Max.	Min.	Max.	Min.	Max.	Min.	Max.
001	.037	.043	.070	.075	—	—	—	—
002	.047	.053	.077	.082	—	—	—	—
003	.057	.063	.088	.093	—	—	—	—
004 to 009	.067	.073	.098	.103	.154	.164	.210	.220
010 to 028	.067	.073	.094	.099	.150	.160	.207	.217
110 to 149	.100	.106	.141	.151	.183	.193	.245	.255
210 to 247	.135	.143	.188	.198	.235	.245	.304	.314
325 to 349	.205	.215	.281	.291	.334	.344	.424	.434
424 to 460	.269	.281	.375	.385	.475	.485	.579	.589

Design Chart 5-1A: Gland Design, O-Ring and Other Elastomeric Seals (SAE AS4716)

Gland Design, O-Ring and Other Elastomeric Seals (SAE AS4716)
 Standard Gland Diametral Clearance Dimensions

Gland and AS568 Dash Number	O-ring Cross Section W		Diametral Clearance E Max.	
	Min.	Max.	Exterior	Interior
001	.037	.043	.004	.004
002	.047	.053	.004	.004
003	.057	.063	.004	.004
004 to 012	.067	.073	.004	.004
013 to 028	.067	.073	.005	.005
110 to 126	.100	.106	.005	.005
127 to 129	.100	.106	.005	.006
130 to 132	.100	.106	.006	.006
133 to 140	.100	.106	.006	.007
141 to 149	.100	.106	.007	.007
210 to 222	.135	.143	.005	.005
223 and 224	.135	.143	.006	.006
225 to 227	.135	.143	.006	.007
228 to 243	.135	.143	.007	.007
244 and 245	.135	.143	.008	.007
246 and 247	.135	.143	.008	.008
325 to 327	.205	.215	.006	.006
328 and 329	.205	.215	.006	.007
330 to 345	.205	.215	.007	.007
346 to 349	.205	.215	.008	.007
425 to 438	.269	.281	.009	.009
439 to 445	.269	.281	.009	.010
446	.269	.281	.010	.010
447 to 460	.269	.281	.011	.010

Design Chart 5-1B: Gland Design, O-Ring and Other Elastomeric Seals (SAE AS4716)

WARNING: These products can expose you to chemicals including carbon black (airborne and extracts), antimony trioxide, titanium dioxide, silica (crystalline), di(2-ethylhexyl) phthalate, ethylene thiourea, acrylonitrile, 1,3-butadiene, epichlorohydrin, toluenediisocyanate, tetrafluoroethylene, ethylbenzene, formaldehyde, furfuryl alcohol, glass fibers, methyl isobutyl ketone, nickel (metallic and compounds), lead and lead compounds which are known to the State of California to cause cancer; and 1,3-butadiene, epichlorohydrin, di(2-ethylhexyl)phthalate, di-isodecyl phthalate, ethylene thiourea, methyl isobutyl ketone, methanol, toluene, lead and lead compounds which are known to the State of California to cause birth defects and other reproductive harm. For more information go to www.P65Warnings.ca.gov.

Gland Design, O-Ring and Other Elastomeric Seals (SAE AS4716)

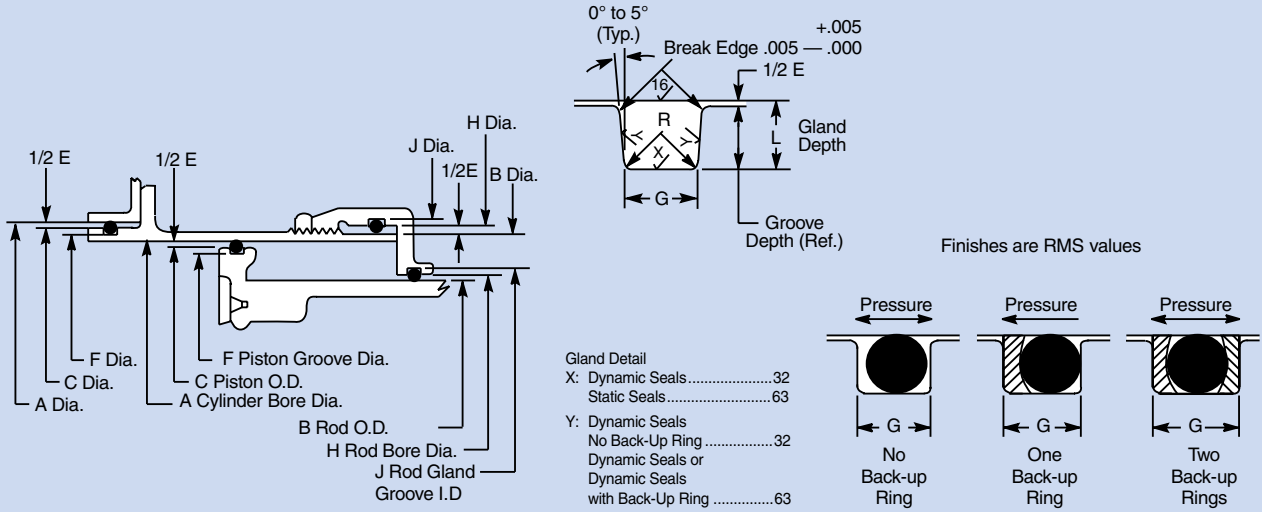

Groove Wall Angle (X)	
Pressure (PSIG)	X (Degrees)
≤ 3000	0.0 +5.0/-0.0
4000 to 6000	0.0 +2.0/-0.0
>6000 to 8000	0.0 ±0.5

Break Edge	
Pressure (PSIG)	Groove Edge Break
≤ 4000	0.005 +0.005/-0.000
> 4000	0.002 +0.008/-0.000

Gland Design, O-Ring and Other Elastomeric Seals (SAE AS4716)

Gland and AS568 Dash No.	Piston or Cylinder OD C	Cylinder Bore OD A	Gland OD F	Rod or Gland Sleeve OD B	Rod Bore ID H	Gland ID J	Actual Minimum Squeeze		Actual Maximum Squeeze	
							Piston	Rod	Piston	Rod
001	0.093	0.095	0.033	0.033	0.035	0.095	0.0000	-	0.0145	-
	0.092	0.096	0.032	0.032	0.036	0.096	-	0.0000	-	0.0145
002	0.126	0.128	0.048	0.048	0.050	0.128	0.0000	-	0.0139	-
	0.125	0.129	0.047	0.047	0.051	0.129	-	0.0000	-	0.0139
003	0.157	0.159	0.063	0.063	0.065	0.159	0.0000	-	0.0154	-
	0.156	0.160	0.062	0.062	0.066	0.160	-	0.0000	-	0.0154
004	0.188	0.190	0.076	0.076	0.078	0.190	0.0003	-	0.0176	-
	0.187	0.191	0.075	0.075	0.079	0.191	-	0.0003	-	0.0176
005	0.219	0.221	0.108	0.108	0.110	0.221	0.0020	-	0.0178	-
	0.218	0.222	0.107	0.107	0.111	0.222	-	0.0020	-	0.0178
006	0.233	0.235	0.123	0.123	0.125	0.235	0.0023	-	0.0177	-
	0.232	0.236	0.122	0.122	0.126	0.236	-	0.0023	-	0.0177
007	0.264	0.266	0.154	0.154	0.156	0.266	0.0032	-	0.0179	-
	0.263	0.267	0.153	0.153	0.157	0.267	-	0.0032	-	0.0179
008	0.295	0.297	0.189	0.185	0.187	0.294	0.0050	-	0.0193	-
	0.294	0.298	0.188	0.184	0.188	0.295	-	0.0053	-	0.0196
009	0.327	0.329	0.220	0.217	0.219	0.327	0.0052	-	0.0192	-
	0.326	0.330	0.219	0.216	0.220	0.328	-	0.0052	-	0.0193
010	0.358	0.360	0.250	0.248	0.250	0.359	0.0052	-	0.0190	-
	0.357	0.361	0.249	0.247	0.251	0.360	-	0.0050	-	0.0189
011	0.420	0.422	0.312	0.310	0.312	0.421	0.0057	-	0.0193	-
	0.419	0.423	0.311	0.309	0.313	0.422	-	0.0054	-	0.0191
012	0.483	0.485	0.375	0.373	0.375	0.484	0.0060	-	0.0194	-
	0.482	0.486	0.374	0.372	0.376	0.485	-	0.0057	-	0.0192
013	0.548	0.550	0.441	0.435	0.437	0.545	0.0050	-	0.0196	-
	0.547	0.552	0.439	0.433	0.438	0.547	-	0.0050	-	0.0198
014	0.611	0.613	0.504	0.498	0.500	0.608	0.0052	-	0.0197	-
	0.610	0.615	0.502	0.496	0.501	0.610	-	0.0051	-	0.0199

Design Table 5-1: Gland Design, O-Ring and Other Elastomeric Seals (SAE AS4716)

WARNING: These products can expose you to chemicals including carbon black (airborne and extracts), antimony trioxide, titanium dioxide, silica (crystalline), di(2-ethylhexyl) phthalate, ethylene thiourea, acrylonitrile, 1,3-butadiene, epichlorohydrin, toluenediisocyanate, tetrafluoroethylene, ethylbenzene, formaldehyde, furfuryl alcohol, glass fibers, methyl isobutyl ketone, nickel (metallic and compounds), lead and lead compounds which are known to the State of California to cause cancer; and 1,3-butadiene, epichlorohydrin, di(2-ethylhexyl)phthalate, di-isodecyl phthalate, ethylene thiourea, methyl isobutyl ketone, methanol, toluene, lead and lead compounds which are known to the State of California to cause birth defects and other reproductive harm. For more information go to www.P65Warnings.ca.gov.

Gland Design, O-Ring and Other Elastomeric Seals (SAE AS4716) (Continued)

Gland and AS568 Dash No.	Piston or Cylinder OD C	Cylinder Bore OD A	Gland OD F	Rod or Gland Sleeve OD B		Rod Bore ID H	Gland ID J	Actual Minimum Squeeze		Actual Maximum Squeeze	
								Piston	Rod	Piston	Rod
015	0.673	0.675	0.566	0.560	0.562	0.670	0.0052	-	0.0200	-	
	0.672	0.677	0.564	0.558	0.563	0.672	-	0.0051	-	0.0202	
016	0.736	0.738	0.629	0.623	0.625	0.733	0.0052	-	0.0203	-	
	0.735	0.740	0.627	0.621	0.626	0.735	-	0.0051	-	0.0205	
017	0.798	0.800	0.691	0.685	0.687	0.795	0.0054	-	0.0204	-	
	0.797	0.802	0.689	0.683	0.688	0.797	-	0.0052	-	0.0205	
018	0.861	0.863	0.753	0.748	0.750	0.858	0.0050	-	0.0200	-	
	0.860	0.865	0.751	0.746	0.751	0.860	-	0.0053	-	0.0205	
019	0.923	0.925	0.815	0.810	0.812	0.920	0.0051	-	0.0200	-	
	0.922	0.927	0.813	0.808	0.813	0.922	-	0.0053	-	0.0205	
020	0.989	0.991	0.881	0.873	0.875	0.983	0.0050	-	0.0198	-	
	0.988	0.993	0.879	0.871	0.876	0.985	-	0.0054	-	0.0205	
021	1.051	1.053	0.943	0.935	0.937	1.045	0.0051	-	0.0199	-	
	1.050	1.055	0.941	0.933	0.938	1.047	-	0.0055	-	0.0205	
022	1.114	1.116	1.006	0.998	1.000	1.108	0.0051	-	0.0200	-	
	1.113	1.118	1.004	0.996	1.001	1.110	-	0.0055	-	0.0205	
023	1.176	1.178	1.068	1.060	1.062	1.170	0.0052	-	0.0200	-	
	1.175	1.180	1.066	1.058	1.063	1.172	-	0.0055	-	0.0205	
024	1.239	1.241	1.131	1.123	1.125	1.233	0.0052	-	0.0200	-	
	1.238	1.243	1.129	1.121	1.126	1.235	-	0.0056	-	0.0205	
025	1.301	1.303	1.193	1.185	1.187	1.295	0.0052	-	0.0201	-	
	1.300	1.305	1.191	1.183	1.188	1.297	-	0.0056	-	0.0205	
026	1.384	1.366	1.256	1.248	1.250	1.358	0.0053	-	0.0201	-	
	1.363	1.368	1.254	1.246	1.251	1.360	-	0.0056	-	0.0205	
027	1.426	1.428	1.318	1.310	1.312	1.420	0.0053	-	0.0202	-	
	1.425	1.430	1.316	1.308	1.313	1.422	-	0.0056	-	0.0205	
028	1.489	1.491	1.381	1.373	1.375	1.483	0.0053	-	0.0203	-	
	1.488	1.493	1.379	1.371	1.376	1.485	-	0.0056	-	0.0205	
110	0.548	0.550	0.379	0.373	0.375	0.546	0.0053	-	0.0204	-	
	0.547	0.552	0.377	0.371	0.376	0.548	-	0.0052	-	0.0204	
111	0.611	0.613	0.441	0.435	0.437	0.609	0.0052	-	0.0202	-	
	0.610	0.615	0.439	0.433	0.438	0.611	-	0.0050	-	0.0201	
112	0.673	0.675	0.502	0.498	0.500	0.672	0.0053	-	0.0201	-	
	0.672	0.677	0.500	0.496	0.501	0.674	-	0.0053	-	0.0203	
113	0.736	0.738	0.565	0.560	0.562	0.734	0.0052	-	0.0204	-	
	0.735	0.740	0.563	0.558	0.563	0.736	-	0.0052	-	0.0207	
114	0.798	0.800	0.627	0.623	0.625	0.797	0.0053	-	0.0210	-	
	0.797	0.802	0.625	0.621	0.626	0.799	-	0.0052	-	0.0211	
115	0.861	0.863	0.689	0.685	0.687	0.859	0.0050	-	0.0206	-	
	0.860	0.865	0.687	0.683	0.688	0.861	-	0.0054	-	0.0212	
116	0.923	0.925	0.751	0.748	0.750	0.923	0.0053	-	0.0208	-	
	0.922	0.927	0.749	0.746	0.751	0.925	-	0.0050	-	0.0207	
117	0.989	0.991	0.817	0.810	0.812	0.985	0.0050	-	0.0205	-	
	0.988	0.993	0.815	0.808	0.813	0.987	-	0.0050	-	0.0209	
118	1.051	1.053	0.879	0.873	0.875	1.048	0.0052	-	0.0207	-	
	1.050	1.055	0.877	0.871	0.876	1.050	-	0.0051	-	0.0209	
119	1.114	1.116	0.942	0.935	0.937	1.110	0.0053	-	0.0206	-	
	1.113	1.118	0.940	0.933	0.938	1.112	-	0.0052	-	0.0209	
120	1.176	1.178	1.003	0.998	1.000	1.173	0.0050	-	0.0204	-	
	1.175	1.180	1.001	0.996	1.001	1.175	-	0.0053	-	0.0209	
121	1.239	1.241	1.066	1.060	1.062	1.235	0.0050	-	0.0203	-	
	1.238	1.243	1.064	1.058	1.063	1.237	-	0.0054	-	0.0209	
122	1.301	1.303	1.128	1.123	1.125	1.298	0.0052	-	0.0204	-	
	1.300	1.305	1.126	1.121	1.126	1.300	-	0.0055	-	0.0209	
123	1.364	1.366	1.191	1.185	1.187	1.360	0.0051	-	0.0205	-	
	1.363	1.368	1.189	1.183	1.188	1.362	-	0.0054	-	0.0210	

Design Table 5-1: Gland Design, O-Ring and Other Elastomeric Seals (SAE AS4716)

WARNING: These products can expose you to chemicals including carbon black (airborne and extracts), antimony trioxide, titanium dioxide, silica (crystalline), di(2-ethylhexyl) phthalate, ethylene thiourea, acrylonitrile, 1,3-butadiene, epichlorohydrin, toluenediisocyanate, tetrafluoroethylene, ethylbenzene, formaldehyde, furfuryl alcohol, glass fibers, methyl isobutyl ketone, nickel (metallic and compounds), lead and lead compounds which are known to the State of California to cause cancer; and 1,3-butadiene, epichlorohydrin, di(2-ethylhexyl)phthalate, di-isodecyl phthalate, ethylene thiourea, methyl isobutyl ketone, methanol, toluene, lead and lead compounds which are known to the State of California to cause birth defects and other reproductive harm. For more information go to www.P65Warnings.ca.gov.

Gland Design, O-Ring and Other Elastomeric Seals (SAE AS4716) (Continued)

Gland and AS568 Dash No.	Piston or Cylinder OD C	Cylinder Bore OD A	Gland OD F	Rod or Gland Sleeve	Rod Bore ID H	Gland ID J	Actual Minimum Squeeze		Actual Maximum Squeeze	
				OD B			Piston	Rod	Piston	Rod
124	1.426	1.428	1.253	1.248	1.250	1.423	0.0052	-	0.0206	-
	1.425	1.430	1.251	1.246	1.251	1.425	-	0.0055	-	0.0210
125	1.489	1.491	1.316	1.310	1.312	1.485	0.0052	-	0.0206	-
	1.488	1.493	1.314	1.308	1.313	1.487	-	0.0055	-	0.0210
126	1.551	1.553	1.378	1.373	1.375	1.548	0.0053	-	0.0207	-
	1.550	1.555	1.376	1.371	1.376	1.550	-	0.0056	-	0.0210
127	1.614	1.616	1.441	1.435	1.437	1.610	0.0053	-	0.0206	-
	1.613	1.618	1.439	1.433	1.439	1.612	-	0.0051	-	0.0215
128	1.676	1.678	1.503	1.498	1.500	1.673	0.0054	-	0.0207	-
	1.675	1.680	1.501	1.496	1.502	1.675	-	0.0052	-	0.0215
129	1.739	1.741	1.566	1.560	1.562	1.735	0.0053	-	0.0208	-
	1.738	1.743	1.564	1.558	1.564	1.737	-	0.0051	-	0.0215
130	1.802	1.805	1.631	1.623	1.625	1.798	0.0053	-	0.0217	-
	1.801	1.807	1.629	1.621	1.627	1.800	-	0.0051	-	0.0215
131	1.864	1.867	1.693	1.685	1.687	1.860	0.0053	-	0.0217	-
	1.863	1.869	1.691	1.683	1.689	1.862	-	0.0052	-	0.0215
132	1.927	1.930	1.756	1.748	1.750	1.923	0.0054	-	0.0217	-
	1.926	1.932	1.754	1.746	1.752	1.925	-	0.0052	-	0.0215
133	1.989	1.992	1.818	1.810	1.813	1.984	0.0054	-	0.0218	-
	1.988	1.994	1.816	1.808	1.815	1.986	-	0.0052	-	0.0225
134	2.052	2.055	1.881	1.873	1.876	2.047	0.0055	-	0.0218	-
	2.051	2.057	1.879	1.871	1.878	2.049	-	0.0053	-	0.0225
135	2.115	2.118	1.944	1.936	1.939	2.110	0.0054	-	0.0219	-
	2.114	2.120	1.942	1.934	1.941	2.112	-	0.0052	-	0.0225
136	2.177	2.180	2.006	1.998	2.001	2.172	0.0055	-	0.0219	-
	2.176	2.182	2.004	1.996	2.003	2.174	-	0.0053	-	0.0225
137	2.240	2.243	2.069	2.061	2.064	2.235	0.0055	-	0.0219	-
	2.239	2.245	2.067	2.059	2.066	2.237	-	0.0053	-	0.0225
138	2.302	2.305	2.131	2.123	2.126	2.297	0.0055	-	0.0219	-
	2.301	2.307	2.129	2.121	2.128	2.299	-	0.0053	-	0.0225
139	2.365	2.368	2.194	2.186	2.189	2.360	0.0056	-	0.0219	-
	2.364	2.370	2.192	2.184	2.191	2.362	-	0.0054	-	0.0225
140	2.427	2.430	2.256	2.248	2.251	2.422	0.0056	-	0.0219	-
	2.426	2.432	2.254	2.246	2.253	2.424	-	0.0054	-	0.0225
141	2.490	2.493	2.319	2.311	2.314	2.485	0.0050	-	0.0225	-
	2.488	2.495	2.317	2.309	2.316	2.487	-	0.0053	-	0.0225
142	2.552	2.555	2.381	2.373	2.376	2.547	0.0051	-	0.0225	-
	2.550	2.557	2.379	2.371	2.378	2.549	-	0.0053	-	0.0225
143	2.615	2.618	2.444	2.436	2.439	2.610	0.0051	-	0.0225	-
	2.613	2.620	2.442	2.434	2.441	2.612	-	0.0054	-	0.0225
144	2.677	2.680	2.506	2.498	2.501	2.672	0.0051	-	0.0225	-
	2.675	2.682	2.504	2.496	2.503	2.674	-	0.0054	-	0.0225
145	2.740	2.743	2.569	2.561	2.564	2.735	0.0052	-	0.0225	-
	2.738	2.745	2.567	2.559	2.566	2.737	-	0.0054	-	0.0225
146	2.802	2.805	2.631	2.623	2.626	2.797	0.0052	-	0.0225	-
	2.800	2.807	2.629	2.621	2.628	2.799	-	0.0054	-	0.0225
147	2.865	2.868	2.694	2.686	2.689	2.860	0.0051	-	0.0225	-
	2.863	2.870	2.692	2.684	2.691	2.862	-	0.0054	-	0.0225
148	2.927	2.930	2.756	2.748	2.751	2.922	0.0052	-	0.0225	-
	2.925	2.932	2.754	2.746	2.753	2.924	-	0.0054	-	0.0225
149	2.990	2.993	2.819	2.811	2.814	2.985	0.0052	-	0.0225	-
	2.988	2.995	2.817	2.809	2.816	2.987	-	0.0054	-	0.0225
210	0.989	0.991	0.750	0.748	0.750	0.989	0.0052	-	0.0244	-
	0.988	0.993	0.748	0.746	0.751	0.991	-	0.0054	-	0.0247
211	1.051	1.053	0.812	0.810	0.812	1.051	0.0054	-	0.0244	-
	1.050	1.055	0.810	0.808	0.813	1.053	-	0.0055	-	0.0248

Design Table 5-1: Gland Design, O-Ring and Other Elastomeric Seals (SAE AS4716)

WARNING: These products can expose you to chemicals including carbon black (airborne and extracts), antimony trioxide, titanium dioxide, silica (crystalline), di(2-ethylhexyl) phthalate, ethylene thiourea, acrylonitrile, 1,3-butadiene, epichlorohydrin, toluenediisocyanate, tetrafluoroethylene, ethylbenzene, formaldehyde, furfuryl alcohol, glass fibers, methyl isobutyl ketone, nickel (metallic and compounds), lead and lead compounds which are known to the State of California to cause cancer; and 1,3-butadiene, epichlorohydrin, di(2-ethylhexyl)phthalate, di-isodecyl phthalate, ethylene thiourea, methyl isobutyl ketone, methanol, toluene, lead and lead compounds which are known to the State of California to cause birth defects and other reproductive harm. For more information go to www.P65Warnings.ca.gov.

Gland Design, O-Ring and Other Elastomeric Seals (SAE AS4716) (Continued)

Gland and AS568 Dash No.	Piston or Cylinder OD C	Cylinder Bore OD A	Gland OD F	Rod or Gland Sleeve OD		Gland ID J	Actual Minimum Squeeze		Actual Maximum Squeeze	
				B	H		Piston	Rod	Piston	Rod
212	1.114	1.116	0.874	0.873	0.875	1.115	0.0051	-	0.0242	-
	1.113	1.118	0.872	0.871	0.876	1.117	-	0.0052	-	0.0243
213	1.176	1.178	0.936	0.935	0.937	1.177	0.0052	-	0.0242	-
	1.175	1.180	0.934	0.933	0.938	1.179	-	0.0053	-	0.0244
214	1.239	1.241	0.999	0.998	1.000	1.240	0.0054	-	0.0243	-
	1.238	1.243	0.997	0.996	1.001	1.242	-	0.0054	-	0.0244
215	1.301	1.303	1.064	1.060	1.062	1.302	0.0067	-	0.0254	-
	1.300	1.305	1.062	1.058	1.063	1.304	-	0.0056	-	0.0244
216	1.364	1.366	1.124	1.123	1.125	1.365	0.0054	-	0.0246	-
	1.363	1.368	1.122	1.121	1.126	1.367	-	0.0055	-	0.0247
217	1.426	1.428	1.186	1.185	1.187	1.427	0.0055	-	0.0246	-
	1.425	1.430	1.184	1.183	1.188	1.429	-	0.0056	-	0.0247
218	1.489	1.491	1.249	1.248	1.250	1.490	0.0056	-	0.0246	-
	1.488	1.493	1.247	1.246	1.251	1.492	-	0.0057	-	0.0247
219	1.551	1.553	1.311	1.310	1.312	1.552	0.0057	-	0.0246	-
	1.550	1.555	1.309	1.308	1.313	1.554	-	0.0058	-	0.0248
220	1.614	1.616	1.374	1.373	1.375	1.615	0.0058	-	0.0247	-
	1.613	1.618	1.372	1.371	1.376	1.617	-	0.0059	-	0.0248
221	1.676	1.678	1.436	1.435	1.437	1.677	0.0059	-	0.0247	-
	1.675	1.680	1.434	1.433	1.438	1.679	-	0.0059	-	0.0248
222	1.739	1.741	1.499	1.498	1.500	1.740	0.0057	-	0.0250	-
	1.738	1.743	1.497	1.496	1.501	1.742	-	0.0058	-	0.0250
223	1.864	1.867	1.625	1.623	1.625	1.865	0.0053	-	0.0254	-
	1.863	1.869	1.623	1.621	1.627	1.867	-	0.0054	-	0.0255
224	1.989	1.992	1.750	1.748	1.750	1.990	0.0055	-	0.0254	-
	1.988	1.994	1.748	1.746	1.752	1.992	-	0.0056	-	0.0255
225	2.115	2.118	1.876	1.873	1.876	2.115	0.0054	-	0.0255	-
	2.114	2.120	1.874	1.871	1.878	2.117	-	0.0050	-	0.0260
226	2.240	2.243	2.001	1.998	2.001	2.240	0.0055	-	0.0255	-
	2.239	2.245	1.999	1.996	2.003	2.242	-	0.0051	-	0.0260
227	2.365	2.368	2.126	2.123	2.126	2.365	0.0056	-	0.0255	-
	2.364	2.370	2.124	2.121	2.128	2.367	-	0.0052	-	0.0260
228	2.490	2.493	2.251	2.248	2.251	2.490	0.0051	-	0.0260	-
	2.488	2.495	2.249	2.246	2.253	2.492	-	0.0052	-	0.0260
229	2.615	2.618	2.376	2.373	2.376	2.615	0.0051	-	0.0260	-
	2.613	2.620	2.374	2.371	2.378	2.617	-	0.0053	-	0.0260
230	2.740	2.743	2.501	2.498	2.501	2.740	0.0052	-	0.0260	-
	2.738	2.745	2.499	2.496	2.503	2.742	-	0.0054	-	0.0260
231	2.865	2.868	2.626	2.623	2.626	2.865	0.0053	-	0.0260	-
	2.863	2.870	2.624	2.621	2.628	2.867	-	0.0054	-	0.0260
232	2.990	2.993	2.751	2.748	2.751	2.990	0.0052	-	0.0260	-
	2.988	2.995	2.749	2.746	2.753	2.992	-	0.0053	-	0.0260
233	3.115	3.118	2.876	2.873	2.876	3.115	0.0053	-	0.0260	-
	3.113	3.120	2.874	2.871	2.878	3.117	-	0.0054	-	0.0260
234	3.240	3.243	3.001	2.997	3.000	3.239	0.0053	-	0.0260	-
	3.238	3.245	2.999	2.995	3.002	3.241	-	0.0055	-	0.0260
235	3.365	3.368	3.126	3.122	3.125	3.364	0.0054	-	0.0260	-
	3.363	3.370	3.124	3.120	3.127	3.366	-	0.0055	-	0.0260
236	3.490	3.493	3.251	3.247	3.250	3.489	0.0054	-	0.0260	-
	3.488	3.495	3.249	3.245	3.252	3.491	-	0.0056	-	0.0260
237	3.615	3.618	3.376	3.372	3.375	3.614	0.0055	-	0.0260	-
	3.613	3.620	3.374	3.370	3.377	3.616	-	0.0056	-	0.0260
238	3.740	3.743	3.501	3.497	3.500	3.739	0.0055	-	0.0260	-
	3.738	3.745	3.499	3.495	3.502	3.741	-	0.0057	-	0.0260
239	3.865	3.868	3.626	3.622	3.625	3.864	0.0055	-	0.0260	-
	3.863	3.870	3.624	3.620	3.627	3.866	-	0.0056	-	0.0260

Design Table 5-1: Gland Design, O-Ring and Other Elastomeric Seals (SAE AS4716)

WARNING: These products can expose you to chemicals including carbon black (airborne and extracts), antimony trioxide, titanium dioxide, silica (crystalline), di(2-ethylhexyl) phthalate, ethylene thiourea, acrylonitrile, 1,3-butadiene, epichlorohydrin, toluenediisocyanate, tetrafluoroethylene, ethylbenzene, formaldehyde, furfuryl alcohol, glass fibers, methyl isobutyl ketone, nickel (metallic and compounds), lead and lead compounds which are known to the State of California to cause cancer; and 1,3-butadiene, epichlorohydrin, di(2-ethylhexyl)phthalate, di-isodecyl phthalate, ethylene thiourea, methyl isobutyl ketone, methanol, toluene, lead and lead compounds which are known to the State of California to cause birth defects and other reproductive harm. For more information go to www.P65Warnings.ca.gov.

Gland Design, O-Ring and Other Elastomeric Seals (SAE AS4716) (Continued)

Gland and AS568 Dash No.	Piston or Cylinder OD C	Cylinder Bore OD A	Gland OD F	Rod or Gland Sleeve	Rod Bore ID H	Gland ID J	Actual Minimum Squeeze		Actual Maximum Squeeze	
				OD B			Piston	Rod	Piston	Rod
240	3.990	3.993	3.751	3.747	3.750	3.989	0.0055	-	0.0260	-
	3.988	3.995	2.749	3.745	3.752	3.991	-	0.0056	-	0.0260
241	4.115	4.118	3.876	3.872	3.875	4.114	0.0056	-	0.0260	-
	4.113	4.120	3.874	3.870	3.877	4.116	-	0.0057	-	0.0260
242	4.240	4.243	4.001	3.997	4.000	4.239	0.0056	-	0.0260	-
	4.238	4.245	3.999	3.995	4.002	4.241	-	0.0057	-	0.0260
243	4.365	4.368	4.126	4.122	4.125	4.364	0.0056	-	0.0260	-
	4.363	4.370	4.124	4.120	4.127	4.366	-	0.0057	-	0.0260
244	4.489	4.493	4.251	4.247	4.250	4.489	0.0051	-	0.0265	-
	4.487	4.495	4.249	4.245	4.252	4.491	-	0.0057	-	0.0260
245	4.614	4.618	4.376	4.372	4.375	4.614	0.0051	-	0.0265	-
	4.612	4.620	4.374	4.370	4.377	4.616	-	0.0058	-	0.0260
246	4.739	4.743	4.501	4.497	4.501	4.739	0.0052	-	0.0265	-
	4.737	4.745	4.499	4.495	4.503	4.741	-	0.0053	-	0.0265
247	4.864	4.868	4.626	4.622	4.626	4.864	0.0052	-	0.0265	-
	4.862	4.870	4.624	4.620	4.628	4.866	-	0.0053	-	0.0265
325	1.864	1.867	1.495	1.498	1.500	1.870	0.0081	-	0.0322	-
	1.863	1.869	1.493	1.496	1.502	1.872	-	0.0079	-	0.0318
326	1.989	1.992	1.620	1.623	1.625	1.995	0.0083	-	0.0323	-
	1.988	1.994	1.618	1.621	1.627	1.997	-	0.0081	-	0.0319
327	2.115	2.118	1.746	1.748	1.750	2.120	0.0085	-	0.0322	-
	2.114	2.120	1.744	1.746	1.752	2.122	-	0.0083	-	0.0320
328	2.240	2.243	1.871	1.873	1.876	2.245	0.0087	-	0.0323	-
	2.239	2.245	1.869	1.871	1.878	2.247	-	0.0080	-	0.0325
329	2.365	2.368	1.996	1.998	2.001	2.370	0.0086	-	0.0326	-
	2.364	2.370	1.994	1.996	2.003	2.372	-	0.0080	-	0.0329
330	2.490	2.493	2.121	2.123	2.126	2.495	0.0083	-	0.0332	-
	2.488	2.495	2.119	2.121	2.128	2.497	-	0.0081	-	0.0330
331	2.615	2.618	2.246	2.248	2.251	2.620	0.0084	-	0.0332	-
	2.613	2.620	2.244	2.246	2.253	2.622	-	0.0083	-	0.0330
332	2.740	2.743	2.371	2.373	2.376	2.745	0.0085	-	0.0332	-
	2.738	2.745	2.369	2.371	2.378	2.747	-	0.0084	-	0.0330
333	2.865	2.868	2.496	2.498	2.501	2.870	0.0085	-	0.0334	-
	2.863	2.870	2.494	2.496	2.503	2.872	-	0.0084	-	0.0332
334	2.990	2.993	2.621	2.623	2.626	2.995	0.0087	-	0.0334	-
	2.988	2.995	2.619	2.621	2.628	2.997	-	0.0085	-	0.0332
335	3.115	3.118	2.746	2.748	2.751	3.120	0.0088	-	0.0334	-
	3.113	3.120	2.744	2.746	2.753	3.122	-	0.0087	-	0.0332
336	3.240	3.243	2.871	2.873	2.876	3.245	0.0089	-	0.0334	-
	3.238	3.245	2.869	2.871	2.878	3.247	-	0.0088	-	0.0332
337	3.365	3.368	2.996	2.997	3.000	3.369	0.0087	-	0.0335	-
	3.363	3.370	2.994	2.995	3.002	3.371	-	0.0087	-	0.0335
338	3.490	3.493	3.121	3.122	3.125	3.494	0.0088	-	0.0335	-
	3.488	3.495	3.119	3.120	3.127	3.496	-	0.0088	-	0.0335
339	3.615	3.618	3.246	3.247	3.250	3.619	0.0089	-	0.0335	-
	3.613	3.620	3.244	3.245	3.252	3.621	-	0.0089	-	0.0335
340	3.740	3.743	3.371	3.372	3.375	3.744	0.0090	-	0.0335	-
	3.738	3.745	3.369	3.370	3.377	3.746	-	0.0090	-	0.0335
341	3.865	3.868	3.496	3.497	3.500	3.869	0.0091	-	0.0335	-
	3.863	3.870	3.494	3.495	3.502	3.871	-	0.0090	-	0.0335
342	3.990	3.993	3.621	3.622	3.625	3.994	0.0090	-	0.0335	-
	3.988	3.995	3.619	3.620	3.627	3.996	-	0.0089	-	0.0335
343	4.115	4.118	3.746	3.747	3.750	4.119	0.0090	-	0.0335	-
	4.113	4.120	3.744	3.745	3.752	4.121	-	0.0090	-	0.0335
344	4.240	4.243	3.871	3.872	3.875	4.244	0.0091	-	0.0335	-
	4.238	4.245	3.869	3.870	3.877	4.246	-	0.0091	-	0.0335

Design Table 5-1: Gland Design, O-Ring and Other Elastomeric Seals (SAE AS4716)

WARNING: These products can expose you to chemicals including carbon black (airborne and extracts), antimony trioxide, titanium dioxide, silica (crystalline), di(2-ethylhexyl) phthalate, ethylene thiourea, acrylonitrile, 1,3-butadiene, epichlorohydrin, toluenediisocyanate, tetrafluoroethylene, ethylbenzene, formaldehyde, furfuryl alcohol, glass fibers, methyl isobutyl ketone, nickel (metallic and compounds), lead and lead compounds which are known to the State of California to cause cancer; and 1,3-butadiene, epichlorohydrin, di(2-ethylhexyl)phthalate, di-isodecyl phthalate, ethylene thiourea, methyl isobutyl ketone, methanol, toluene, lead and lead compounds which are known to the State of California to cause birth defects and other reproductive harm. For more information go to www.P65Warnings.ca.gov.

Dynamic O-Ring Sealing

Gland Design, O-Ring and Other Elastomeric Seals (SAE AS4716) (Continued)

Gland and AS568 Dash No.	Piston or Cylinder OD C	Cylinder Bore OD A	Gland OD F	Rod or Gland Sleeve	Rod Bore ID H	Gland ID J	Actual Minimum Squeeze		Actual Maximum Squeeze	
				OD B			Piston	Rod	Piston	Rod
345	4.365	4.368	3.966	3.997	4.000	4.369	0.0092	-	0.0335	-
	4.363	4.370	3.994	3.995	4.002	4.371	-	0.0091	-	0.0335
346	4.489	4.493	4.121	4.122	4.125	4.494	0.0087	-	0.0340	-
	4.487	4.495	4.119	4.120	4.127	4.496	-	0.0092	-	0.0335
347	4.614	4.618	4.246	4.247	4.250	4.619	0.0087	-	0.0340	-
	4.612	4.620	4.244	4.245	4.252	4.621	-	0.0092	-	0.0335
348	4.739	4.743	4.371	4.372	4.375	4.744	0.0088	-	0.0340	-
	4.737	4.745	4.369	4.370	4.377	4.746	-	0.0092	-	0.0335
349	4.864	4.868	4.496	4.497	4.500	4.869	0.0088	-	0.0340	-
	4.862	4.870	4.494	4.495	4.502	4.871	-	0.0093	-	0.0335
425	4.970	4.974	4.497	4.497	4.501	4.974	0.0175	-	0.0480	-
	4.968	4.977	4.494	4.494	4.503	4.977	-	0.0175	-	0.0480
426	5.095	5.099	4.622	4.622	4.626	5.099	0.0176	-	0.0480	-
	5.093	5.102	4.619	4.619	4.628	5.102	-	0.0176	-	0.0480
427	5.220	5.224	4.747	4.747	4.751	5.224	0.0176	-	0.0480	-
	5.218	5.227	4.744	4.744	4.753	5.227	-	0.0176	-	0.0480
428	5.345	5.349	4.872	4.872	4.876	5.349	0.0177	-	0.0480	-
	5.343	5.352	4.869	4.869	4.878	5.352	-	0.0177	-	0.0480
429	5.470	5.474	4.997	4.997	5.001	5.474	0.0176	-	0.0480	-
	5.468	5.477	4.994	4.994	5.003	5.477	-	0.0176	-	0.0480
430	5.595	5.599	5.122	5.122	5.126	5.599	0.0176	-	0.0480	-
	5.593	5.602	5.119	5.119	5.128	5.602	-	0.0176	-	0.0480
431	5.720	5.724	5.247	5.247	5.251	5.724	0.0177	-	0.0480	-
	5.718	5.727	5.244	5.244	5.253	5.727	-	0.0177	-	0.0480
432	5.845	5.849	5.372	5.372	5.376	5.849	0.0178	-	0.0480	-
	5.843	5.852	5.369	5.369	5.378	5.852	-	0.0178	-	0.0480
433	5.970	5.974	5.497	5.497	5.501	5.974	0.0178	-	0.0480	-
	5.968	5.977	5.494	5.494	5.503	5.977	-	0.0178	-	0.0480
434	6.095	6.099	5.622	5.622	5.626	6.099	0.0179	-	0.0480	-
	6.093	6.102	5.619	5.619	5.628	6.102	-	0.0179	-	0.0480
435	6.220	6.224	5.747	5.747	5.751	6.224	0.0179	-	0.0480	-
	6.218	6.227	5.744	5.744	5.753	6.227	-	0.0179	-	0.0480
436	6.345	6.349	5.872	5.872	5.876	6.349	0.0180	-	0.0480	-
	6.343	6.352	5.869	5.869	5.878	6.352	-	0.0180	-	0.0480
437	6.470	6.474	5.997	5.997	6.001	6.474	0.0180	-	0.0480	-
	6.468	6.477	5.994	5.994	6.003	6.477	-	0.0180	-	0.0480
438	6.720	6.724	6.247	6.247	6.251	6.724	0.0180	-	0.0480	-
	6.718	6.727	6.244	6.244	6.253	6.727	-	0.0180	-	0.0480
439	6.970	6.974	6.497	6.497	6.501	6.974	0.0181	-	0.0480	-
	6.968	6.977	6.494	6.494	6.504	6.977	-	0.0176	-	0.0485
440	7.220	7.224	6.747	6.747	6.751	7.224	0.0182	-	0.0480	-
	7.218	7.227	6.744	6.744	6.754	7.227	-	0.0177	-	0.0485
441	7.470	7.474	6.997	6.997	7.001	7.474	0.0182	-	0.0480	-
	7.468	7.477	6.994	6.994	7.004	7.477	-	0.0177	-	0.0485
442	7.720	7.724	7.247	7.247	7.251	7.724	0.0181	-	0.0480	-
	7.718	7.727	7.244	7.244	7.254	7.727	-	0.0176	-	0.0485
443	7.970	7.974	7.497	7.497	7.501	7.974	0.0182	-	0.0480	-
	7.968	7.977	7.494	7.494	7.504	7.977	-	0.0177	-	0.0485
444	8.220	8.224	7.747	7.747	7.751	8.224	0.0183	-	0.0480	-
	8.218	8.227	7.744	7.744	7.754	8.227	-	0.0178	-	0.0485
445	8.470	8.474	7.997	7.997	8.001	8.474	0.0183	-	0.0480	-
	8.468	8.477	7.994	7.994	8.004	8.477	-	0.0178	-	0.0485
446	8.970	8.974	8.497	8.497	8.501	8.974	0.0177	-	0.0485	-
	8.967	8.977	8.494	8.494	8.504	8.977	-	0.0177	-	0.0485
447	9.470	9.474	8.997	8.997	9.001	9.474	0.0168	-	0.0485	-
	9.467	9.478	8.994	8.994	9.004	9.478	-	0.0173	-	0.0485

Design Table 5-1: Gland Design, O-Ring and Other Elastomeric Seals (SAE AS4716)

WARNING: These products can expose you to chemicals including carbon black (airborne and extracts), antimony trioxide, titanium dioxide, silica (crystalline), di(2-ethylhexyl) phthalate, ethylene thiourea, acrylonitrile, 1,3-butadiene, epichlorohydrin, toluenediisocyanate, tetrafluoroethylene, ethylbenzene, formaldehyde, furfuryl alcohol, glass fibers, methyl isobutyl ketone, nickel (metallic and compounds), lead and lead compounds which are known to the State of California to cause cancer; and 1,3-butadiene, epichlorohydrin, di(2-ethylhexyl)phthalate, di-isodecyl phthalate, ethylene thiourea, methyl isobutyl ketone, methanol, toluene, lead and lead compounds which are known to the State of California to cause birth defects and other reproductive harm. For more information go to www.P65Warnings.ca.gov.

Gland Design, O-Ring and Other Elastomeric Seals (SAE AS4716) (Continued)

Gland and AS568 Dash No.	Piston or Cylinder OD C	Cylinder Bore OD A	Gland OD F	Rod or Gland Sleeve OD B	Rod Bore ID H	Gland ID J	Actual Minimum Squeeze		Actual Maximum Squeeze	
							Piston	Rod	Piston	Rod
448	9.970	9.974	9.497	9.497	9.501	9.974	0.0169	-	0.0485	-
	9.967	9.978	9.494	9.494	9.504	9.978	-	0.0174	-	0.0485
449	10.470	10.474	9.997	9.997	10.001	10.474	0.0170	-	0.0485	-
	10.467	10.478	9.994	9.994	10.004	10.478	-	0.0175	-	0.0485
450	10.970	10.974	10.497	10.497	10.501	10.974	0.0170	-	0.0485	-
	10.967	10.978	10.494	10.494	10.504	10.978	-	0.0175	-	0.0485
451	11.470	11.474	10.997	10.997	11.001	11.474	0.0170	-	0.0485	-
	11.467	11.478	10.994	10.994	11.004	11.478	-	0.0176	-	0.0485
452	11.970	11.974	11.497	11.497	11.501	11.974	0.0171	-	0.0485	-
	11.967	11.978	11.494	11.494	11.504	11.978	-	0.0176	-	0.0485
453	12.470	12.474	11.997	11.997	12.001	12.474	0.0172	-	0.0485	-
	12.467	12.478	11.994	11.994	12.004	12.478	-	0.0177	-	0.0485
454	12.970	12.974	12.497	12.497	12.501	12.974	0.0173	-	0.0485	-
	12.967	12.978	12.494	12.494	12.504	12.978	-	0.0178	-	0.0485
455	13.470	13.474	12.997	12.997	13.001	13.474	0.0173	-	0.0485	-
	13.467	13.478	12.994	12.994	13.004	13.478	-	0.0178	-	0.0485
456	13.970	13.974	13.497	13.497	13.501	13.974	0.0172	-	0.0485	-
	13.967	13.978	13.494	13.494	13.504	13.978	-	0.0177	-	0.0485
457	14.470	14.474	13.997	13.997	14.001	14.474	0.0173	-	0.0485	-
	14.467	14.478	13.994	13.994	14.004	14.478	-	0.0178	-	0.0485
458	14.970	14.974	14.497	14.497	14.501	14.974	0.0173	-	0.0485	-
	14.967	14.978	14.494	14.494	14.504	14.978	-	0.0178	-	0.0485
459	15.470	15.474	14.997	14.997	15.001	15.474	0.0174	-	0.0485	-
	15.467	15.478	14.994	14.994	15.004	15.478	-	0.0179	-	0.0485
460	15.970	15.974	15.497	15.497	15.501	15.974	0.0174	-	0.0485	-
	15.967	15.978	15.494	15.494	15.504	15.978	-	0.0179	-	0.0485

Design Table 5-1: Gland Design, O-Ring and Other Elastomeric Seals (SAE AS4716)

WARNING: These products can expose you to chemicals including carbon black (airborne and extracts), antimony trioxide, titanium dioxide, silica (crystalline), di(2-ethylhexyl) phthalate, ethylene thiourea, acrylonitrile, 1,3-butadiene, epichlorohydrin, toluenediisocyanate, tetrafluoroethylene, ethylbenzene, formaldehyde, furfuryl alcohol, glass fibers, methyl isobutyl ketone, nickel (metallic and compounds), lead and lead compounds which are known to the State of California to cause cancer; and 1,3-butadiene, epichlorohydrin, di(2-ethylhexyl)phthalate, di-isodecyl phthalate, ethylene thiourea, methyl isobutyl ketone, methanol, toluene, lead and lead compounds which are known to the State of California to cause birth defects and other reproductive harm. For more information go to www.P65Warnings.ca.gov.

5.31.2 O-Ring Glands for Industrial Reciprocating Seals

Design Chart 5-2 provides a reasonable basis for calculating reciprocating O-ring seal glands. Design Table 5-2, which follows it, contains recommended gland dimensions for the standard AS568A O-ring sizes. The major difference from the military gland dimensions (Design Table 5-1) is the use of standard cylinder bore and standard rod dimensions.

Although these dimensions are suitable for most reciprocating designs, it is often desirable, or even necessary, to deviate from them. Other portions of this handbook on Basic O-Ring Elastomers (Section II) and O-Ring Applications (Section III) are helpful in determining when such special designs are indicated and provide useful data for such modified designs.

Procedures for using Design Table 5-2 are outlined in Design Guide 5-2. See Section X, Table 10-6 for installation guidelines.

Gland Dimensions for Industrial Reciprocating O-Ring Seals

Groove Diameter (Rod Gland) Tolerance

- .000 for all sizes
- + .002 for sizes 2-006 through 2-324
- + .004 for sizes 2-325 through 2-460

Groove Diameter (Piston) Tolerance

- + .000 for all sizes
- .002 for sizes 2-006 through 2-324
- .004 for sizes 2-325 through 2-460

Design Guide 5-2a: Gland Dimensions for Industrial Reciprocating O-Ring Seals

If Desired Dimension is Known for	Select Closest Dimension in Column	Read Horizontally in Column	To Determine Dimension for
Bore Dia of cylinder	A	B-1 C G	Groove Dia of piston OD of piston Groove width
OD of piston	C	A B-1 G	Bore Dia of cylinder Groove Dia of piston Groove width
OD of rod	B	A-1 D G	Groove Dia for rod Bore ID for rod Groove width
Bore Dia for rod	D	A-1 B G	Groove Dia for rod OD of rod Groove width

Design Guide 5-2b: Guide For Design Table 5-2

After selecting gland dimensions, read horizontally to determine proper O-ring size number. Specify compound.

Industrial Reciprocating O-Ring Packing Glands

O-Ring 2-Size AS568A-	W Cross-Section		L Gland Depth	Squeeze		E(a) Diametral Clearance	G-GrooveWidth			R Groove Radius	Max. Eccentricity (b)
	Nominal	Actual		Actual	%		No Parbak Ring(G)	One Parbak Ring(G ₁)	Two Parbak Rings(G ₂)		
006 through 012	1/16	.070 ± .003	.055 to .057	.010 to .018	15 to 25	.002 to .005	.093 to .098	.138 to .143	.205 to .210	.005 to .015	.002
104 through 116	3/32	.103 ± .003	.088 to .090	.010 to .018	10 to 17	.002 to .005	.140 to .145	.171 to .176	.238 to .243	.005 to .015	.002
201 through 222	1/8	.139 ± .004	.121 to .123	.012 to .022	9 to 16	.003 to .006	.187 to .192	.208 to .213	.275 to .280	.010 to .025	.003
309 through 349	3/16	.210 ± .005	.185 to .188	.017 to .030	8 to 14	.003 to .006	.281 to .286	.311 to .316	.410 to .415	.020 to .035	.004
425 through 460	1/4	.275 ± .006	.237 to .240	.029 to .044	11 to 16	.004 to .007	.375 to .380	.408 to .413	.538 to .543	.020 to .035	.005

(a) Clearance (extrusion gap) must be held to a minimum consistent with design requirements for temperature range variation.
 (b) Total indicator reading between groove and adjacent bearing surface.

Design Chart 5-2-a: Design Chart for Industrial Reciprocating O-Ring Packing Glands

⚠ WARNING: These products can expose you to chemicals including carbon black (airborne and extracts), antimony trioxide, titanium dioxide, silica (crystalline), di(2-ethylhexyl) phthalate, ethylene thiourea, acrylonitrile, 1,3-butadiene, epichlorohydrin, toluenediisocyanate, tetrafluoroethylene, ethylbenzene, formaldehyde, furfuryl alcohol, glass fibers, methyl isobutyl ketone, nickel (metallic and compounds), lead and lead compounds which are known to the State of California to cause cancer; and 1,3-butadiene, epichlorohydrin, di(2-ethylhexyl)phthalate, di-isodecyl phthalate, ethylene thiourea, methyl isobutyl ketone, methanol, toluene, lead and lead compounds which are known to the State of California to cause birth defects and other reproductive harm. For more information go to www.P65Warnings.ca.gov.

Industrial Reciprocating O-Ring Packing Glands

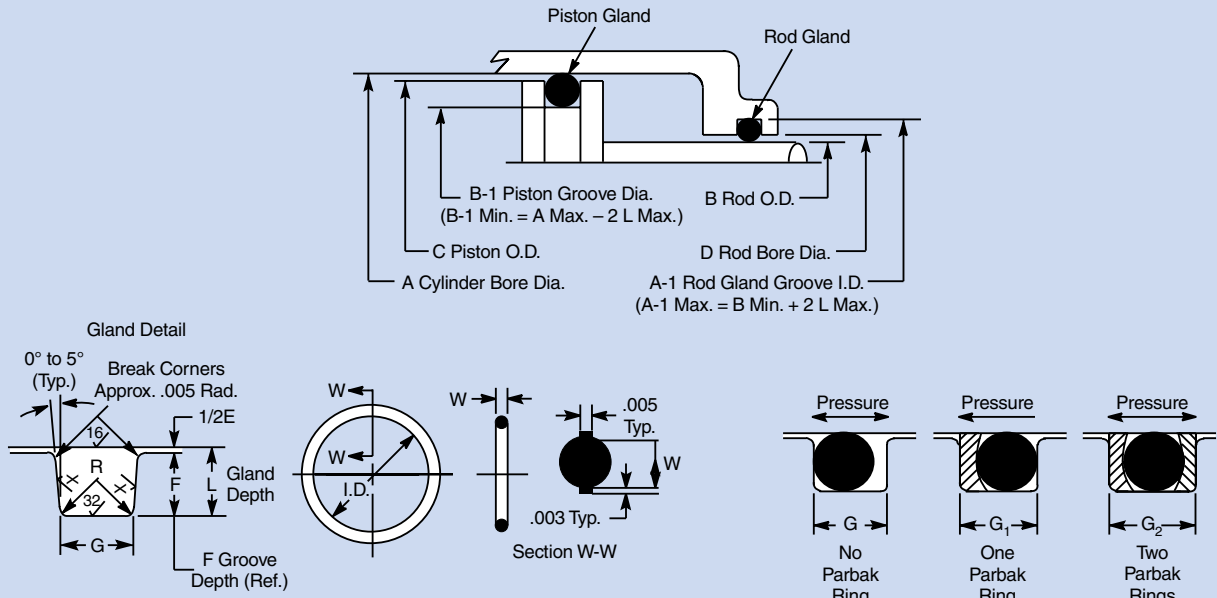

Surface Finish X:
32 Without Parbak Ring
63 With Parbak Ring

Finishes are RMS values

Refer to Design Chart 5-2 (below) and Design Table 5-2 for dimensions.

Industrial Dynamic Metric Cross-Sections

Industrial Dynamic Metric Cross-Sections

W Cross-Section	L Gland Depth	G-Groove Width No Parbak Ring (G)	R Groove Radius
1.50	1.30	1.90	0.20 to 0.40
1.80	1.45	2.40	0.20 to 0.40
2.00	1.70	2.60	0.20 to 0.40
2.50	2.10	3.30	0.20 to 0.40
2.65	2.20	3.60	0.20 to 0.40
3.00	2.60	3.90	0.40 to 0.80
3.55	3.05	4.80	0.40 to 0.80
4.00	3.50	5.30	0.40 to 0.80
5.00	4.45	6.70	0.40 to 0.80
5.30	4.65	7.10	0.40 to 0.80
6.00	5.40	8.00	0.40 to 0.80
7.00	6.20	9.50	0.40 to 0.80

(a) Dimensions are in mm. The ISO/DIN recommendations are preferred.
(b) Parbaks are not available in standard for metric sizes.

Design Chart 5-2-b: Design Chart for Industrial Dynamic Metric Cross-Sections

WARNING: These products can expose you to chemicals including carbon black (airborne and extracts), antimony trioxide, titanium dioxide, silica (crystalline), di(2-ethylhexyl) phthalate, ethylene thiourea, acrylonitrile, 1,3-butadiene, epichlorohydrin, toluenediisocyanate, tetrafluoroethylene, ethylbenzene, formaldehyde, furfuryl alcohol, glass fibers, methyl isobutyl ketone, nickel (metallic and compounds), lead and lead compounds which are known to the State of California to cause cancer; and 1,3-butadiene, epichlorohydrin, di(2-ethylhexyl)phthalate, di-isodecyl phthalate, ethylene thiourea, methyl isobutyl ketone, methanol, toluene, lead and lead compounds which are known to the State of California to cause birth defects and other reproductive harm. For more information go to www.P65Warnings.ca.gov.

Gland Dimensions for Industrial Reciprocating O-Ring Seals, 103.5 Bar (1500 psi) Max.†

O-Ring Size Parker No. 2-	Dimensions			A	A-1 Groove Dia. (Rod)	B	B-1 Groove Dia. *(Piston)	C	D	G	
	I.D.	±	W	Mean O.D. (Ref)	Bore Dia. (Cylinder) +0.02 -0.000	OD (Rod) +0.000 -0.002	OD (Rod) +0.000 -0.002	OD (Piston) +0.000 -0.001	Bore Dia. (Rod) +0.001 -0.000	Width Groove +0.005 -0.000	
006	.114	.005	↑	.254	.249	.234	.124	.139	*.247	.126	↑
007	.145	.005	↑	.285	.280	.265	.155	.170	*.278	.157	↑
008	.176	.005	↑	.316	.311	.296	.186	.201	*.309	.188	↑
009	.208	.005	.070	.348	.343	.328	.218	.233	*.341	.220	.093
010	.239	.005	±.003	.379	.374	.359	.249	.264	*.372	.251	↑
011	.301	.005	↓	.441	.436	.421	.311	.326	*.434	.313	↓
012	.364	.005	↓	.504	.499	.484	.374	.389	*.497	.376	↓
104	.112	.005	↑	.318	.312	.300	.124	.136	*.310	.126	↑
105	.143	.005	↑	.349	.343	.331	.155	.167	*.341	.157	↑
106	.174	.005	↑	.380	.374	.362	.186	.198	*.372	.188	↑
107	.206	.005	↑	.412	.406	.394	.218	.230	*.404	.220	↑
108	.237	.005	↑	.443	.437	.425	.249	.261	*.435	.251	↑
109	.299	.005	↑	.505	.499	.487	.311	.323	*.497	.313	↑
110	.362	.005	.103	.568	.562	.550	.374	.386	*.560	.376	.140
111	.424	.005	±.003	.630	.624	.612	.436	.448	*.622	.438	↑
112	.487	.005	↓	.693	.687	.675	.499	.511	*.685	.501	↓
113	.549	.007	↓	.755	.749	.737	.561	.573	*.747	.563	↓
114	.612	.009	↓	.818	.812	.800	.624	.636	.810	.626	↓
115	.674	.009	↓	.880	.874	.862	.686	.698	.872	.688	↓
116	.737	.009	↓	.943	.937	.925	.749	.761	.935	.751	↓
201	.171	.005	↑	.449	.437	.427	.185	.195	*.434	.188	↑
202	.234	.005	↑	.512	.500	.490	.248	.258	*.497	.251	↑
203	.296	.005	↑	.574	.562	.552	.310	.320	*.559	.313	↑
204	.359	.005	↑	.637	.625	.615	.373	.383	.622	.376	↑
205	.421	.005	↑	.699	.687	.677	.435	.445	.684	.438	↑
206	.484	.005	↑	.762	.750	.740	.498	.508	.747	.501	↑
207	.546	.007	↑	.824	.812	.802	.560	.570	.809	.563	↑
208	.609	.009	↑	.887	.875	.865	.623	.633	.872	.626	↑
209	.671	.009	↑	.949	.937	.927	.685	.695	.934	.688	↑
210	.734	.010	↑	1.012	1.000	.990	.748	.758	.997	.751	↑
211	.796	.010	.139	1.074	1.062	1.052	.810	.820	1.059	.813	.187
212	.859	.010	±.004	1.137	1.125	1.115	.873	.883	1.122	.876	↑
213	.921	.010	↑	1.199	1.187	1.177	.935	.945	1.184	.938	↑
214	.984	.010	↑	1.262	1.250	1.240	.998	1.008	1.247	1.001	↑
215	1.046	.010	↑	1.324	1.312	1.302	1.060	1.070	1.309	1.063	↑
216	1.109	.012	↑	1.387	1.375	1.365	1.123	1.133	1.372	1.126	↑
217	1.171	.012	↑	1.449	1.437	1.427	1.185	1.195	1.434	1.188	↑
218	1.234	.012	↑	1.512	1.500	1.490	1.248	1.258	1.497	1.251	↑
219	1.296	.012	↑	1.574	1.562	1.552	1.310	1.320	1.559	1.313	↑
220	1.359	.012	↑	1.637	1.625	1.615	1.373	1.383	1.622	1.376	↑
221	1.421	.012	↑	1.699	1.687	1.677	1.435	1.445	1.684	1.438	↑
222	1.484	.015	↓	1.762	1.750	1.740	1.498	1.508	1.747	1.501	↓

* These designs require considerable installation stretch. If assembly breakage is incurred use a compound having higher elongation or use a two-piece piston.
† This groove width does not permit the use of Parbak rings. For pressures above 103.5 Bar (1500 psi), consult Design Chart 5-2 for groove widths where Parbak rings must be used.

Design Table 5-2: Gland Dimensions for Industrial Reciprocating O-Ring Seals, 103.5 Bar (1500 psi) Max.†

WARNING: These products can expose you to chemicals including carbon black (airborne and extracts), antimony trioxide, titanium dioxide, silica (crystalline), di(2-ethylhexyl) phthalate, ethylene thiourea, acrylonitrile, 1,3-butadiene, epichlorohydrin, toluenediisocyanate, tetrafluoroethylene, ethylbenzene, formaldehyde, furfuryl alcohol, glass fibers, methyl isobutyl ketone, nickel (metallic and compounds), lead and lead compounds which are known to the State of California to cause cancer; and 1,3-butadiene, epichlorohydrin, di(2-ethylhexyl)phthalate, di-isodecyl phthalate, ethylene thiourea, methyl isobutyl ketone, methanol, toluene, lead and lead compounds which are known to the State of California to cause birth defects and other reproductive harm. For more information go to www.P65Warnings.ca.gov.

Gland Dimensions for Industrial Reciprocating O-Ring Seals, 103.5 Bar (1500 psi) Max.† (Continued)

O-Ring Size Parker No. 2-	Dimensions			A	A-1 Groove Dia. (Rod)	B	B-1 Groove Dia. *(Piston)	C	D	G
	I.D.	±	W	Mean O.D. (Ref)	Bore Dia. (Cylinder) +0.02 -0.00	OD (Rod) +0.00 -0.02	OD (Rod) +0.00 -0.02	OD (Piston) +0.00 -0.01	Bore Dia. (Rod) +0.01 -0.00	Width Groove +0.05 -0.00
309	.412	.005		.832	.812	.805	.435	.442	*.809	.438
310	.475	.005		.895	.875	.868	.498	.505	*.872	.501
311	.537	.007		.957	.937	.930	.560	.567	*.943	.563
312	.600	.009		1.020	1.000	.993	.623	.630	.997	.626
313	.662	.009		1.082	1.062	1.055	.685	.692	1.059	.688
314	.725	.010		1.145	1.125	1.118	.748	.755	1.122	.751
315	.787	.010		1.207	1.187	1.180	.810	.817	1.184	.813
316	.850	.010		1.270	1.250	1.243	.873	.880	1.247	.876
317	.912	.010		1.332	1.312	1.305	.935	.942	1.309	.938
318	.975	.010		1.395	1.375	1.368	.998	1.005	1.372	1.001
319	1.037	.010		1.457	1.437	1.430	1.060	1.067	1.434	1.063
320	1.100	.012		1.520	1.500	1.493	1.123	1.130	1.497	1.126
321	1.162	.012		1.582	1.562	1.555	1.185	1.192	1.559	1.188
322	1.225	.012		1.645	1.625	1.618	1.248	1.255	1.622	1.251
323	1.287	.012		1.707	1.687	1.680	1.310	1.317	1.648	1.313
324	1.350	.012		1.770	1.750	1.743	1.373	1.380	1.747	1.376
						+0.04 -0.00		+0.00 -0.04		
325	1.475	.015		1.895	1.875	1.868	1.498	1.505	1.872	1.501
326	1.600	.015		2.020	2.000	1.993	1.623	1.630	1.997	1.626
327	1.725	.015		2.145	2.125	2.118	1.748	1.755	2.122	1.751
328	1.850	.015		2.270	2.250	2.243	1.873	1.880	2.247	1.876
329	1.975	.018	.210	2.395	2.375	2.368	1.998	2.005	2.372	2.001
330	2.100	.018	±.005	2.520	2.500	2.493	2.123	2.130	2.497	2.126
331	2.225	.018		2.645	2.625	2.618	2.248	2.255	2.622	2.251
332	2.350	.018		2.770	2.750	2.743	2.373	2.380	2.747	2.376
333	2.475	.020		2.895	2.875	2.868	2.498	2.505	2.872	2.501
334	2.600	.020		3.020	3.000	2.993	2.623	2.630	2.997	2.626
335	2.725	.020		3.145	3.125	3.118	2.748	2.755	3.122	2.751
336	2.850	.020		3.270	3.250	3.243	2.873	2.880	3.247	2.876
337	2.975	.024		3.395	3.375	3.368	2.998	3.005	3.372	3.001
338	3.100	.024		3.520	3.500	3.493	3.123	3.130	3.497	3.126
339	3.225	.024		3.645	3.625	3.618	3.248	3.255	3.622	3.251
340	3.350	.024		3.770	3.750	3.743	3.373	3.380	3.747	3.376
341	3.475	.024		3.895	3.875	3.868	3.498	3.505	3.872	3.501
342	3.600	.028		4.020	4.000	3.993	3.623	3.630	3.997	3.626
343	3.725	.028		4.145	4.125	4.118	3.748	3.755	4.122	3.751
344	3.850	.028		4.270	4.250	4.243	3.873	3.880	4.247	3.876
345	3.975	.028		4.395	4.375	4.368	3.998	4.005	4.372	4.001
346	4.100	.028		4.520	4.500	4.493	4.123	4.130	4.497	4.126
347	4.225	.030		4.645	4.625	4.618	4.248	4.255	4.622	4.251
348	4.350	.030		4.773	4.750	4.743	4.373	4.380	4.747	4.376
349	4.475	.030		4.895	4.875	4.868	4.498	4.505	4.872	4.501

* These designs require considerable installation stretch. If assembly breakage is incurred use a compound having higher elongation or use a two-piece piston.
† This groove width does not permit the use of Parbak rings. For pressures above 103.5 Bar (1500 psi), consult Design Chart 5-2 for groove widths where Parbak rings must be used.

Design Table 5-2: Gland Dimensions for Industrial Reciprocating O-Ring Seals, 103.5 Bar (1500 psi) Max.†

⚠ WARNING: These products can expose you to chemicals including carbon black (airborne and extracts), antimony trioxide, titanium dioxide, silica (crystalline), di(2-ethylhexyl) phthalate, ethylene thiourea, acrylonitrile, 1,3-butadiene, epichlorohydrin, toluenediisocyanate, tetrafluoroethylene, ethylbenzene, formaldehyde, furfuryl alcohol, glass fibers, methyl isobutyl ketone, nickel (metallic and compounds), lead and lead compounds which are known to the State of California to cause cancer; and 1,3-butadiene, epichlorohydrin, di(2-ethylhexyl)phthalate, di-isodecyl phthalate, ethylene thiourea, methyl isobutyl ketone, methanol, toluene, lead and lead compounds which are known to the State of California to cause birth defects and other reproductive harm. For more information go to www.P65Warnings.ca.gov.

Gland Dimensions for Industrial Reciprocating O-Ring Seals, 103.5 Bar (1500 psi) Max.† (Continued)

O-Ring Size Parker No. 2-	Dimensions			Mean O.D. (Ref)	A	A-1 Groove Dia. (Rod Gland)	B	B-1 Groove Dia. *(Piston)	C	D	G
	I.D.	±	W		Bore Dia. (Cylinder)	OD (Rod)	OD (Piston)	Bore Dia. (Rod)	Width Groove		
425	4.475	.033		5.025	5.002	4.971	4.497	4.528	4.998	4.501	
426	4.600	.033		5.150	5.127	5.096	4.622	4.653	5.123	4.626	
427	4.725	.033		5.275	5.252	5.221	4.747	4.778	5.248	4.751	
428	4.850	.033		5.400	5.377	5.346	4.872	4.903	5.373	4.876	
429	4.975	.037		5.525	5.502	5.471	4.997	5.028	5.498	5.001	
430	5.100	.037		5.650	5.627	5.596	5.122	5.153	5.623	5.126	
431	5.225	.037		5.775	5.752	5.721	5.247	5.278	5.748	5.251	
432	5.350	.037		5.900	5.877	5.846	5.372	5.403	5.873	5.376	
433	5.475	.037		6.025	6.002	5.971	5.497	5.528	5.998	5.501	
434	5.600	.037		6.150	6.127	6.096	5.622	5.653	6.123	5.626	
435	5.725	.037		6.275	6.252	6.221	5.747	5.778	6.248	5.751	
436	5.850	.037		6.400	6.377	6.346	5.872	5.903	6.373	5.876	
437	5.975	.037		6.525	6.502	6.471	5.997	6.028	6.498	6.001	
438	6.225	.040		6.775	6.752	6.721	6.247	6.278	6.748	6.251	
439	6.475	.040		7.025	7.002	6.971	6.497	6.528	6.998	6.501	
440	6.725	.040		7.275	7.252	7.221	6.747	6.778	7.248	6.751	
441	6.975	.040		7.525	7.502	7.471	6.997	7.028	7.498	7.001	
442	7.225	.045	.275	7.775	7.752	7.721	7.247	7.278	7.748	7.251	.375
443	7.475	.045	±.006	8.025	8.002	7.971	7.497	7.528	7.998	7.501	
444	7.725	.045		8.275	8.252	8.221	7.747	7.778	8.248	7.751	
445	7.975	.045		8.525	8.502	8.471	7.997	8.028	8.498	8.001	
446	8.475	.055		9.025	9.002	8.971	8.497	8.528	8.998	8.501	
447	8.975	.055		9.525	9.502	9.471	8.997	9.028	9.498	9.001	
448	9.475	.055		10.025	10.002	9.971	9.497	9.528	9.998	9.501	
449	9.975	.055		10.525	10.502	10.471	9.997	10.028	10.498	10.001	
450	10.475	.060		11.025	11.002	10.971	10.497	10.528	10.998	10.501	
451	10.975	.060		11.525	11.502	11.471	10.997	11.028	11.498	11.001	
452	11.475	.060		12.025	12.002	11.971	11.497	11.528	11.998	11.501	
453	11.975	.060		12.525	12.502	12.471	11.997	12.028	12.498	12.001	
454	12.475	.060		13.025	13.002	12.971	12.497	12.528	12.998	12.501	
455	12.975	.060		13.525	13.502	13.471	12.997	13.028	13.498	13.001	
456	13.475	.070		14.025	14.002	13.971	13.497	13.528	13.998	13.501	
457	13.975	.070		14.525	14.502	14.471	13.997	14.028	14.498	14.001	
458	14.475	.070		15.025	15.002	14.971	14.497	14.528	14.998	14.501	
459	14.975	.070		15.525	15.502	15.471	14.997	15.028	15.498	15.001	
460	15.475	.070		16.025	16.002	15.971	15.497	15.528	15.998	15.501	

* These designs require considerable installation stretch. If assembly breakage is incurred use a compound having higher elongation or use a two-piece piston.
 † This groove width does not permit the use of Parbak rings. For pressures above 103.5 Bar (1500 psi), consult Design Chart 5-2 for groove widths where Parbak rings must be used.

Design Table 5-2: Gland Dimensions for Industrial Reciprocating O-Ring Seals, 103.5 Bar (1500 psi) Max.†

WARNING: These products can expose you to chemicals including carbon black (airborne and extracts), antimony trioxide, titanium dioxide, silica (crystalline), di(2-ethylhexyl) phthalate, ethylene thiourea, acrylonitrile, 1,3-butadiene, epichlorohydrin, toluenediisocyanate, tetrafluoroethylene, ethylbenzene, formaldehyde, furfuryl alcohol, glass fibers, methyl isobutyl ketone, nickel (metallic and compounds), lead and lead compounds which are known to the State of California to cause cancer; and 1,3-butadiene, epichlorohydrin, di(2-ethylhexyl)phthalate, di-isodecyl phthalate, ethylene thiourea, methyl isobutyl ketone, methanol, toluene, lead and lead compounds which are known to the State of California to cause birth defects and other reproductive harm. For more information go to www.P65Warnings.ca.gov.

5.31.3 O-Ring Glands for Pneumatic Floating Piston Ring Seals

Design Chart 5-3 provides the basis for calculating gland dimensions. For standard O-ring sizes, these dimensions have been calculated and are listed in Design Table 5-3. The procedures for the use of Design Table 5-3 are outlined in Design Guide 5-3.

After selecting gland dimensions, read horizontally to determine proper O-ring size number. Specify compound.

Refer to 8-2, Military Fluid Specification Description, Fluid Compatibility Tables, or Table 3-1 to select the proper compound. The effective part number for an O-ring consists of both a size number and a compound number.

If Desired Dimension is Known for	Dimension in Column	Select Closest Horizontally in Column	Read to Determine Dimension for
Bore Dia of cylinder	A	B-1	Groove Dia of piston
		C	OD of piston
		G	Groove width
		A	Bore Dia of cylinder
OD of piston	C	B-1	Groove Dia of piston
		G	Groove width

Design Guide 5-3: Guide For Design Table 5-3

Floating Pneumatic Piston Ring Seal Glands 13.8 Bar (200 psi) Max.

0° to 5° Typ. (0° Preferred)
 Break Edges Approx. .005 Rad.
 1/2 E
 F Groove Depth (Ref.)
 Gland Depth
 .005 Typ.
 .003 Typ.
 Section W-W
 Finishes are RMS values

Refer to Design Chart 5-3 (below) and Design Table 5-3 for dimensions.

O-Ring Size (a) Parker No. 2-	W Cross Section Nominal	W Cross Section Actual	P (c) Peripheral Squeeze (Variable)	L Gland Depth	G Groove Width	E Diametral Clearance	Eccentricity Max. (b)	R Groove Radius
006 through 012	1/16	.070 ± .003	.035 to .042	.072 to .076	.075 to .079	.002 to .010	.002	.005 to .015
104 through 116	3/32	.103 ± .003	.038 to .062	.105 to .109	.111 to .115	.002 to .010	.002	.005 to .015
201 through 222	1/8	.139 ± .004	.061 to .082	.143 to .147	.151 to .155	.003 to .011	.003	.010 to .025
309 through 349	3/16	.210 ± .005	.084 to .124	.214 to .218	.229 to .233	.003 to .011	.004	.020 to .035
425 through 460	1/4	.275 ± .006	.140 to .175	.282 to .286	.301 to .305	.004 to .012	.005	.020 to .035

(a) Only sizes listed are recommended for this design.
 (b) Total indicator reading between groove and adjacent bearing surface.
 (c) Use to calculate A^{min} diameter.

Design Chart 5-3: Design Chart for Floating Pneumatic Piston Ring Seal Glands

WARNING: These products can expose you to chemicals including carbon black (airborne and extracts), antimony trioxide, titanium dioxide, silica (crystalline), di(2-ethylhexyl) phthalate, ethylene thiourea, acrylonitrile, 1,3-butadiene, epichlorohydrin, toluenediisocyanate, tetrafluoroethylene, ethylbenzene, formaldehyde, furfuryl alcohol, glass fibers, methyl isobutyl ketone, nickel (metallic and compounds), lead and lead compounds which are known to the State of California to cause cancer; and 1,3-butadiene, epichlorohydrin, di(2-ethylhexyl)phthalate, di-isodecyl phthalate, ethylene thiourea, methyl isobutyl ketone, methanol, toluene, lead and lead compounds which are known to the State of California to cause birth defects and other reproductive harm. For more information go to www.P65Warnings.ca.gov.

Floating Pneumatic Piston Ring Seal Gland Dimensions

O-Ring Size Parker No. 2-	Dimensions			Mean O.D. (Ref)	A Bore Dia. (Cylinder) +.004 -.000	B-1 Groove Dia. (Piston) +.000 -.004	C OD (Piston) +.000 -.004	G Groove Width +.004 -.000	P Peripheral Squeeze
	I.D.	±	W		±	±	±	±	±
006	.114	.005	↑	.254	.219	.075	*.217	↑	.035
007	.145	.005	↑	.285	.249	.105	*.247	↑	.036
008	.176	.005	↑	.316	.279	.135	*.277	↑	.037
009	.208	.005	.070	.348	.309	.165	*.307	.075	.039
010	.239	.005	±.003	.379	.339	.195	*.337	↑	.040
011	.301	.005	↓	.441	.400	.256	*.398	↓	.041
012	.364	.005	↓	.504	.462	.318	.460	↓	.042
104	.112	.005	↑	.318	.280	.070	*.278	↑	.038
105	.143	.005	↑	.349	.309	.099	*.307	↑	.040
106	.174	.005	↑	.380	.338	.128	*.336	↑	.042
107	.206	.005	↑	.412	.368	.158	*.366	↑	.044
108	.237	.005	↑	.443	.397	.187	*.395	↑	.046
109	.299	.005	↑	.505	.457	.247	*.455	↑	.048
110	.362	.005	.103	.568	.518	.308	*.516	.111	.050
111	.424	.005	±.003	.630	.578	.368	*.576	↑	.052
112	.487	.005	↓	.693	.639	.429	.637	↓	.054
113	.549	.007	↓	.755	.699	.489	.697	↓	.056
114	.612	.009	↓	.818	.760	.550	.758	↓	.058
115	.674	.009	↓	.880	.820	.610	.818	↓	.060
116	.737	.009	↓	.943	.881	.671	.879	↓	.062
201	.171	.005	↑	.449	.388	.102	*.385	↑	.061
202	.234	.005	↑	.512	.450	.164	*.447	↑	.062
203	.296	.005	↑	.574	.511	.255	*.508	↑	.063
204	.359	.005	↑	.637	.573	.287	.570	↑	.064
205	.421	.005	↑	.699	.634	.348	.631	↑	.065
206	.484	.005	↑	.762	.696	.410	.693	↑	.066
207	.546	.007	↑	.824	.757	.471	.754	↑	.067
208	.609	.009	↑	.887	.819	.533	.816	↑	.068
209	.671	.009	↑	.949	.880	.594	.877	↑	.069
210	.734	.010	↑	1.012	.942	.656	.939	↑	.070
211	.796	.010	.139	1.074	1.003	.717	1.000	.151	.071
212	.859	.010	±.004	1.137	1.065	.779	1.026	↑	.072
213	.921	.010	↑	1.199	1.126	.840	1.123	↑	.073
214	.984	.010	↑	1.262	1.188	.902	1.185	↑	.074
215	1.046	.010	↑	1.324	1.249	.963	1.246	↑	.075
216	1.109	.012	↑	1.387	1.311	1.025	1.308	↑	.076
217	1.171	.012	↑	1.449	1.372	1.086	1.369	↑	.077
218	1.234	.012	↑	1.512	1.434	1.148	1.431	↑	.078
219	1.296	.012	↑	1.574	1.495	1.209	1.492	↑	.079
220	1.359	.012	↑	1.637	1.557	1.271	1.554	↑	.080
221	1.421	.012	↓	1.699	1.618	1.332	1.615	↓	.081
222	1.484	.015	↓	1.762	1.680	1.394	1.677	↓	.082
309	.412	.005	.210	.832	.748	.320	.745	.229	.084
310	.475	.005	±.105	.895	.810	.382	.807	↓	.085
311	.537	.007	↓	.957	.871	.443	.868	↓	.086

* These designs require considerable installation stretch. If assembly breakage is incurred use a compound having higher elongation or use a two-piece piston.

Design Table 5-3: Floating Pneumatic Piston Ring Seal Gland Dimensions

WARNING: These products can expose you to chemicals including carbon black (airborne and extracts), antimony trioxide, titanium dioxide, silica (crystalline), di(2-ethylhexyl) phthalate, ethylene thiourea, acrylonitrile, 1,3-butadiene, epichlorohydrin, toluenediisocyanate, tetrafluoroethylene, ethylbenzene, formaldehyde, furfuryl alcohol, glass fibers, methyl isobutyl ketone, nickel (metallic and compounds), lead and lead compounds which are known to the State of California to cause cancer; and 1,3-butadiene, epichlorohydrin, di(2-ethylhexyl)phthalate, di-isodecyl phthalate, ethylene thiourea, methyl isobutyl ketone, methanol, toluene, lead and lead compounds which are known to the State of California to cause birth defects and other reproductive harm. For more information go to www.P65Warnings.ca.gov.

Design Table 5-3 – Floating Pneumatic Piston Ring Seal Gland Dimensions (Continued)

O-Ring Size Parker No. 2-	Dimensions			Mean O.D. (Ref)	A Bore Dia. (Cylinder) +.004 -.000	B-1 Groove Dia. (Piston) +.000 -.004	C OD (Piston) +.000 -.004	G Groove Width +.004 -.000	P Peripheral Squeeze
	I.D.	±	W						
312	.600	.009	↑	1.020	.933	.505	.930	↑	.087
313	.662	.009	↑	1.082	.994	.566	.991	↑	.088
314	.725	.010	↑	1.145	1.056	.628	1.053	↑	.089
315	.787	.010	↑	1.207	1.117	.689	1.114	↑	.090
316	.850	.010	↑	1.270	1.179	.751	1.176	↑	.091
317	.912	.010	↑	1.332	1.240	.812	1.237	↑	.092
318	.975	.010	↑	1.395	1.302	.874	1.299	↑	.093
319	1.037	.010	↑	1.457	1.363	.935	1.360	↑	.094
320	1.100	.012	↑	1.520	1.425	.997	1.422	↑	.095
321	1.162	.012	↑	1.582	1.486	1.058	1.483	↑	.096
322	1.225	.012	↑	1.645	1.548	1.120	1.545	↑	.097
323	1.287	.012	↑	1.707	1.609	1.181	1.636	↑	.098
324	1.350	.012	↑	1.770	1.671	1.243	1.668	↑	.099
325	1.475	.015	↑	1.895	1.795	1.367	1.792	↑	.100
326	1.600	.015	↑	2.020	1.919	1.491	1.916	↑	.101
327	1.725	.015	↑	2.145	2.043	1.615	2.040	↑	.102
328	1.850	.015	↑	2.270	2.167	1.739	2.164	↑	.103
329	1.975	.018	.210	2.395	2.291	1.863	2.288	.229	.104
330	2.100	.018	±.005	2.520	2.415	1.987	2.412	↑	.105
331	2.225	.018	↑	2.645	2.539	2.111	2.536	↑	.106
332	2.350	.018	↑	2.770	2.663	2.235	2.660	↑	.107
333	2.475	.020	↑	2.895	2.787	2.359	2.784	↑	.108
334	2.600	.020	↑	3.020	2.911	2.483	2.908	↑	.109
335	2.725	.020	↑	3.145	3.035	2.607	3.032	↑	.110
336	2.850	.020	↑	3.270	3.159	2.731	3.156	↑	.111
337	2.975	.024	↑	3.395	3.283	2.855	3.280	↑	.112
338	3.100	.024	↑	3.520	3.407	2.979	3.404	↑	.113
339	3.225	.024	↑	3.645	3.531	3.103	3.528	↑	.114
340	3.350	.024	↑	3.770	3.655	3.270	3.652	↑	.115
341	3.475	.024	↑	3.895	3.779	3.351	3.776	↑	.116
342	3.600	.028	↑	4.020	3.903	3.475	3.900	↑	.117
343	3.725	.028	↑	4.145	4.027	3.599	4.024	↑	.118
344	3.850	.028	↑	4.270	4.151	3.723	4.148	↑	.119
345	3.975	.028	↑	4.395	4.275	3.847	4.272	↑	.120
346	4.100	.028	↑	4.520	4.399	3.971	4.396	↑	.121
347	4.225	.030	↑	4.645	4.523	4.095	4.520	↑	.122
348	4.350	.030	↑	4.773	4.647	4.219	4.644	↑	.123
349	4.475	.030	↑	4.895	4.771	4.343	4.768	↑	.124
425	4.475	.033	↑	5.025	4.885	4.321	4.881	↑	.140
426	4.600	.033	↑	5.150	5.009	4.445	5.005	↑	.141
427	4.725	.033	↑	5.275	5.133	4.569	5.129	↑	.142
428	4.850	.033	.275	5.400	5.257	4.693	5.253	.301	.143
429	4.975	.037	±.006	5.525	5.381	4.817	5.377	↑	.144
430	5.100	.037	↑	5.650	5.505	4.941	5.501	↑	.145
431	5.225	.037	↑	5.775	5.629	5.065	5.625	↑	.146
432	5.350	.037	↑	5.900	5.753	5.189	5.749	↑	.147

* These designs require considerable installation stretch. If assembly breakage is incurred use a compound having higher elongation or use a two-piece piston.

Design Table 5-3: Floating Pneumatic Piston Ring Seal Gland Dimensions

WARNING: These products can expose you to chemicals including carbon black (airborne and extracts), antimony trioxide, titanium dioxide, silica (crystalline), di(2-ethylhexyl) phthalate, ethylene thiourea, acrylonitrile, 1,3-butadiene, epichlorohydrin, toluenediisocyanate, tetrafluoroethylene, ethylbenzene, formaldehyde, furfuryl alcohol, glass fibers, methyl isobutyl ketone, nickel (metallic and compounds), lead and lead compounds which are known to the State of California to cause cancer; and 1,3-butadiene, epichlorohydrin, di(2-ethylhexyl)phthalate, di-isodecyl phthalate, ethylene thiourea, methyl isobutyl ketone, methanol, toluene, lead and lead compounds which are known to the State of California to cause birth defects and other reproductive harm. For more information go to www.P65Warnings.ca.gov.

Design Table 5-3 – Floating Pneumatic Piston Ring Seal Gland Dimensions (Continued)

O-Ring Size Parker No. 2-	I.D.	Dimensions		Mean O.D. (Ref)	A	B-1	C	G	P
		±	W		Bore Dia. (Cylinder) +.004 -.000	Groove Dia. (Piston) +.000 -.004	OD (Piston) +.000 -.004	Groove Width +.004 -.000	Peripheral Squeeze
433	5.475	.037	↑	6.025	5.877	5.313	5.873	↑	.148
434	5.600	.037	↑	6.150	6.001	5.437	5.997	↑	.149
435	5.725	.037	↑	6.275	6.125	5.561	6.121	↑	.150
436	5.850	.037	↑	6.400	6.249	5.685	6.245	↑	.151
437	5.975	.037	↑	6.525	6.373	5.809	6.369	↑	.152
438	6.225	.040	↑	6.775	6.622	6.058	6.618	↑	.153
439	6.475	.040	↑	7.025	6.871	6.307	6.867	↑	.154
440	6.725	.040	↑	7.275	7.120	6.556	7.116	↑	.155
441	6.975	.040	↑	7.525	7.369	6.805	7.365	↑	.156
442	7.225	.045	.275	7.775	7.618	7.054	7.614	.301	.157
443	7.475	.045	±.006	8.025	7.867	7.303	7.863	↑	.158
444	7.725	.045	↑	8.275	8.116	7.552	8.112	↑	.159
445	7.975	.045	↑	8.525	8.365	7.801	8.361	↑	.160
446	8.475	.055	↑	9.025	8.864	8.300	8.860	↑	.161
447	8.975	.055	↑	9.525	9.363	8.799	9.359	↑	.162
448	9.475	.055	↑	10.025	9.862	9.298	9.858	↑	.163
449	9.975	.055	↑	10.525	10.361	9.797	10.357	↑	.164
450	10.475	.060	↑	11.025	10.860	10.296	10.856	↑	.165
451	10.975	.060	↑	11.525	11.359	10.795	11.355	↑	.166
452	11.475	.060	↑	12.025	11.858	11.294	11.854	↑	.167
453	11.975	.060	↑	12.525	12.357	11.793	12.353	↑	.168
454	12.475	.060	↑	13.025	12.856	12.292	12.852	↑	.169
455	12.975	.060	↑	13.525	13.355	12.791	13.351	↑	.170
456	13.475	.070	↑	14.025	13.854	13.290	13.850	↑	.171
457	13.975	.070	↑	14.525	14.353	13.789	14.349	↑	.172
458	14.475	.070	↑	15.025	14.852	14.288	14.848	↑	.173
459	14.975	.070	↓	15.525	15.351	14.787	15.347	↓	.174
460	15.475	.070	↓	16.025	15.850	15.286	15.846	↓	.175

* These designs require considerable installation stretch. If assembly breakage is incurred use a compound having higher elongation or use a two-piece piston.

Design Table 5-3: Floating Pneumatic Piston Ring Seal Gland Dimensions

Guide For Design Table 5-4

If Desired Dimension is Known for	Select Closest Dimension in Column	Read Horizontally in Column	To Determine Dimension for
OD of shaft	B	A-1 D G	Groove Dia. for shaft Throat Dia. Groove width
Throat Dia.	D	A-1 B G	Groove Dia. for shaft OD of shaft Groove width

Design Guide 5-4: Guide For Design Table 5-4

WARNING: These products can expose you to chemicals including carbon black (airborne and extracts), antimony trioxide, titanium dioxide, silica (crystalline), di(2-ethylhexyl) phthalate, ethylene thiourea, acrylonitrile, 1,3-butadiene, epichlorohydrin, toluenediisocyanate, tetrafluoroethylene, ethylbenzene, formaldehyde, furfuryl alcohol, glass fibers, methyl isobutyl ketone, nickel (metallic and compounds), lead and lead compounds which are known to the State of California to cause cancer; and 1,3-butadiene, epichlorohydrin, di(2-ethylhexyl)phthalate, di-isodecyl phthalate, ethylene thiourea, methyl isobutyl ketone, methanol, toluene, lead and lead compounds which are known to the State of California to cause birth defects and other reproductive harm. For more information go to www.P65Warnings.ca.gov.

5.31.4 O-Ring Glands for Rotary Seals

Design Chart 5-4 provides the basis for calculating gland dimensions. For standard O-ring sizes, these dimensions have been calculated and are listed in Design Table 5-4. The procedures for the use of Design Table 5-4 are outlined in Design Guide 5-4 below.

After selecting gland dimensions, read horizontally to determine proper O-ring size number. Specify compound. Refer to the discussion on rotary seals earlier in this chapter for the selection of the proper compound. The effective part number for an O-ring consists of both a size number and a compound number.

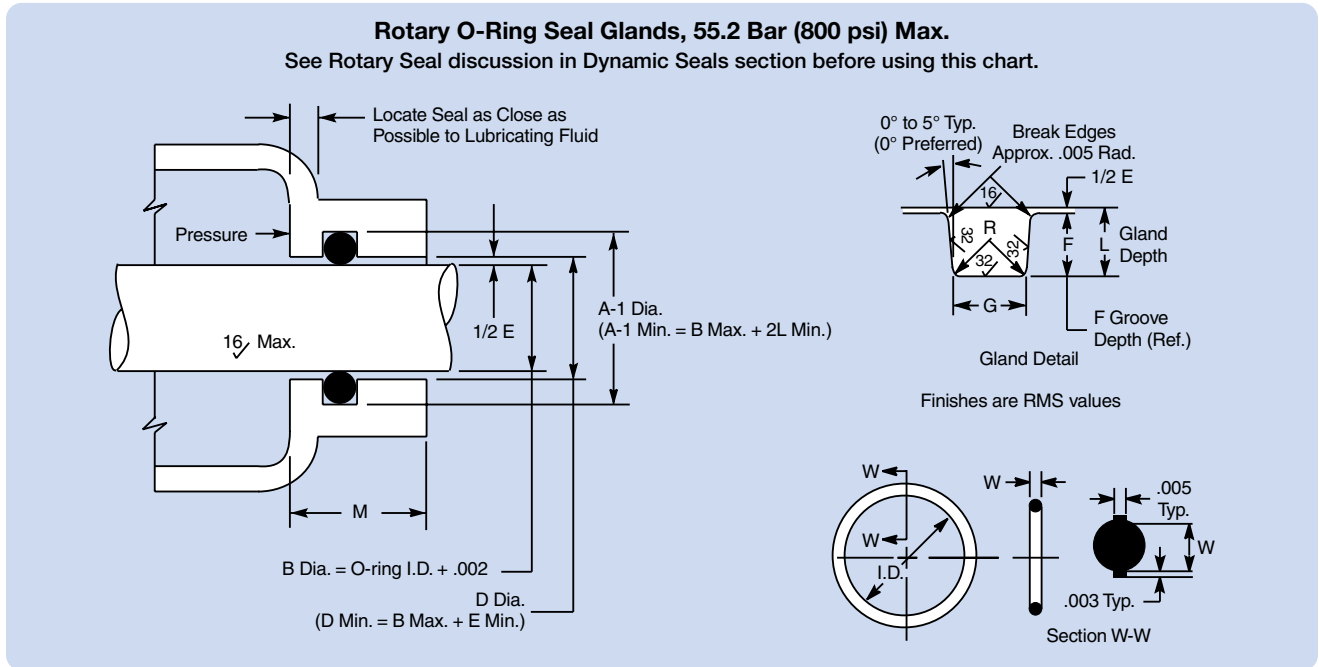

Note: Due to effect of centrifugal force, do not locate groove in shaft. Refer to Design Chart 5-4 (below) and Design Table 5-4 for dimensions.

Rotary O-Ring Seal Glands, 55.2 Bar (800 psi) Max. (c)
(Below 200 FPM, Use Design Chart 5-2)

O-Ring Size Parker No. 2-	W Cross Section		Maximum Speed FPM (a)	Squeeze %	L Gland Depth	G Groove Width	E (c) Diametral Clearance	Eccentricity Max (b)	M Bearing Length Min. (c)	R Groove Radius
004 through 045	1/16	0.070 ±.003	200 to 1500	0-11	0.065 to 0.067	0.075 to 0.079	0.012 to 0.016	0.002	0.700	0.005 to 0.015
102 through 163	3/32	0.103 ±.003	200 to 600	1-8 1/2	0.097 to 0.099	0.108 to 0.112	0.012 to 0.016	0.002	1.030	0.005 to 0.015
201 through 258	1/8	0.139 ±.004	200 to 400	0-7	0.133 to 0.135	0.144 to 0.148	0.016 to 0.020	0.003	1.390	0.010 to 0.025

- (a) Feet per minute = 0.26 X Shaft Diameter (inches) X rpm.
- (b) Total indicator reading between groove OD, shaft, and adjacent bearing surface.
- (c) If clearance (extrusion gap) must be reduced for higher pressures, bearing length M must be no less than the minimum figures given. Clearances given are based on the use of 80 shore durometer minimum O-ring for 55.2 Bar (800 psi) max. See Figure 3-2 for recommended clearances when pressures exceed 55.2 Bar (800 psi).

Design Chart 5-4: Design Chart for Rotary O-Ring Seal Glands

WARNING: These products can expose you to chemicals including carbon black (airborne and extracts), antimony trioxide, titanium dioxide, silica (crystalline), di(2-ethylhexyl) phthalate, ethylene thiourea, acrylonitrile, 1,3-butadiene, epichlorohydrin, toluenediisocyanate, tetrafluoroethylene, ethylbenzene, formaldehyde, furfuryl alcohol, glass fibers, methyl isobutyl ketone, nickel (metallic and compounds), lead and lead compounds which are known to the State of California to cause cancer; and 1,3-butadiene, epichlorohydrin, di(2-ethylhexyl)phthalate, di-isodecyl phthalate, ethylene thiourea, methyl isobutyl ketone, methanol, toluene, lead and lead compounds which are known to the State of California to cause birth defects and other reproductive harm. For more information go to www.P65Warnings.ca.gov.

Rotary O-Ring Seal Gland Dimensions

O-Ring Size Parker No. 2-	Dimensions			Mean O.D. (Ref)	B OD (Shaft) +.000 -0.001	A-1 Groove Dia. (Gland) +.003 -0.000	D Throat Dia. +.003 -0.000	G Groove Width +.004 -0.000
	I.D.	±	W					
004	.070	.005	↑	.210	.072	.202	.084	↑
005	.101	.005	↑	.241	.103	.233	.115	↑
006	.114	.005	↑	.254	.116	.246	.128	↑
007	.145	.005	↑	.285	.147	.277	.159	↑
008	.176	.005	↑	.316	.178	.308	.190	↑
009	.208	.005	↑	.348	.210	.340	.222	↑
010	.239	.005	↑	.379	.241	.371	.253	↑
011	.301	.005	↑	.441	.303	.433	.315	↑
012	.364	.005	↑	.504	.366	.496	.378	↑
013	.426	.005	↑	.566	.428	.558	.440	↑
014	.489	.005	↑	.629	.491	.621	.503	↑
015	.551	.007	↑	.691	.553	.683	.565	↑
016	.614	.009	↑	.754	.616	.746	.628	↑
017	.676	.009	↑	.816	.678	.808	.693	↑
018	.739	.009	.070	.879	.741	.871	.753	.075
019	.801	.009	±.003	.941	.803	.933	.815	↑
020	.864	.009	↑	1.004	.866	.996	.878	↑
021	.926	.009	↑	1.066	.928	1.058	.940	↑
022	.989	.010	↑	1.129	.991	1.121	1.003	↑
023	1.051	.010	↑	1.191	1.053	1.183	1.065	↑
024	1.114	.010	↑	1.254	1.116	1.246	1.128	↑
025	1.176	.011	↑	1.316	1.178	1.308	1.190	↑
026	1.239	.011	↑	1.379	1.241	1.371	1.253	↑
027	1.301	.011	↑	1.441	1.303	1.433	1.315	↑
028	1.364	.013	↑	1.504	1.366	1.496	1.378	↑
029	1.489	.013	↑	1.629	1.491	1.621	1.503	↑
030	1.614	.013	↑	1.754	1.616	1.746	1.628	↑
031	1.739	.015	↑	1.879	1.741	1.871	1.753	↑
032	1.864	.015	↑	2.004	1.866	1.996	1.878	↑
033	1.989	.018	↑	2.129	1.991	2.121	2.003	↑
034	2.114	.018	↑	2.254	2.116	2.246	2.128	↑
035	2.239	.018	↑	2.379	2.241	2.371	2.253	↑
036	2.364	.018	↑	2.504	2.366	2.496	2.378	↑
037	2.489	.018	↑	2.629	2.491	2.621	2.503	↑
038	2.614	.020	↑	2.754	2.616	2.746	2.628	↑
039	2.739	.020	↑	2.879	2.741	2.871	2.753	↑
040	2.864	.020	↑	3.004	2.866	2.996	2.878	↑
041	2.989	.024	↑	3.129	2.991	3.121	3.003	↑
042	3.239	.024	↑	3.379	3.241	3.371	3.253	↑
043	3.489	.024	↑	3.629	3.491	3.621	3.503	↑
044	3.739	.027	↓	3.879	3.741	3.871	3.753	↓
045	3.989	.027	↓	4.129	3.991	4.121	4.003	↓
102	.049	.005	↑	.255	.051	.245	.063	↑
103	.081	.005	.103	.287	.083	.277	.095	.108
104	.112	.005	±.003	.318	.114	.308	.126	↑
105	.143	.005	↓	.349	.145	.339	.157	↓
106	.174	.005	↓	.380	.176	.370	.188	↓

† For pressures over 55.2 Bar (800 psi), consult Design Chart 5-4 and the design sections of this Handbook.

Design Table 5-4: Rotary O-Ring Seal Gland Dimensions

⚠ WARNING: These products can expose you to chemicals including carbon black (airborne and extracts), antimony trioxide, titanium dioxide, silica (crystalline), di(2-ethylhexyl) phthalate, ethylene thiourea, acrylonitrile, 1,3-butadiene, epichlorohydrin, toluenediisocyanate, tetrafluoroethylene, ethylbenzene, formaldehyde, furfuryl alcohol, glass fibers, methyl isobutyl ketone, nickel (metallic and compounds), lead and lead compounds which are known to the State of California to cause cancer; and 1,3-butadiene, epichlorohydrin, di(2-ethylhexyl)phthalate, di-isodecyl phthalate, ethylene thiourea, methyl isobutyl ketone, methanol, toluene, lead and lead compounds which are known to the State of California to cause birth defects and other reproductive harm. For more information go to www.P65Warnings.ca.gov.

Rotary O-Ring Seal Gland Dimensions (Continued)

O-Ring Size Parker No. 2-	Dimensions			Mean O.D. (Ref)	B OD (Shaft) +.000 -0.001	A-1 Groove Dia. (Gland) +.003 -0.000	D Throat Dia. +.003 -0.000	G Groove Width +.004 -0.000
	I.D.	±	W					
107	.206	.005	↑	.412	.208	.402	.220	↑
108	.237	.005		.443	.239	.433	.251	
109	.299	.005		.505	.301	.495	.313	
110	.362	.005		.568	.364	.558	.376	
111	.424	.005		.630	.426	.620	.438	
112	.487	.005		.693	.489	.683	.501	
113	.549	.007		.755	.551	.745	.563	
114	.612	.009		.818	.614	.808	.626	
115	.674	.009		.880	.676	.870	.688	
116	.737	.009		.943	.739	.933	.751	
117	.799	.010		1.005	.801	.995	.813	
118	.862	.010	1.068	.864	1.058	.876		
119	.924	.010	1.130	.926	1.120	.938		
120	.987	.010	.103 1.193	.989	1.183	1.001	.108	
121	1.049	.010 ±.003	1.255	1.051	1.245	1.063		
122	1.112	.010	1.318	1.114	1.308	1.126		
123	1.174	.012	1.380	1.176	1.370	1.188		
124	1.237	.012	1.443	1.239	1.433	1.251		
125	1.299	.012	1.505	1.301	1.495	1.313		
126	1.362	.012	1.568	1.364	1.558	1.376		
127	1.424	.012	1.630	1.426	1.620	1.438		
128	1.487	.012	1.693	1.489	1.683	1.501		
129	1.549	.015	1.755	1.551	1.745	1.563		
130	1.612	.015	1.818	1.614	1.808	1.626		
131	1.674	.015	1.880	1.676	1.870	1.688		
132	1.737	.015	1.943	1.739	1.933	1.751		
133	1.799	.015	2.005	1.801	1.995	1.813		
134	1.862	.015	2.068	1.864	2.058	1.876		
135	1.925	.017	2.131	1.927	2.121	1.939		
136	1.987	.017	2.193	1.989	2.183	2.001		
137	2.050	.017	2.256	2.052	2.246	2.064		
138	2.112	.017	2.318	2.114	2.308	2.126		
139	2.175	.017	2.381	2.177	2.371	2.189		
140	2.237	.017	2.443	2.239	2.433	2.251		
141	2.300	.020	2.506	2.302	2.496	2.314		
142	2.362	.020	2.568	2.364	2.558	2.376		
143	2.425	.020	2.631	2.427	2.621	2.439		
144	2.487	.020	2.693	2.489	2.683	2.501		
145	2.550	.020	2.756	2.552	2.746	2.564		
146	2.612	.020	2.818	2.614	2.808	2.626		
147	2.675	.022	2.881	2.677	2.871	2.689		
148	2.737	.022	2.943	2.739	2.933	2.751		
149	2.800	.022	3.006	2.802	2.996	2.814		
150	2.862	.022	3.068	2.864	3.058	2.876		
151	2.987	.024	3.193	2.989	3.183	3.001		
152	3.237	.024	3.443	3.239	3.433	3.251		
153	3.487	.024	3.693	3.489	3.683	3.501	↓	

† For pressures over 55.2 Bar (800 psi), consult Design Chart 5-4 and the design sections of this Handbook.

Design Table 5-4: Rotary O-Ring Seal Gland Dimensions

⚠ WARNING: These products can expose you to chemicals including carbon black (airborne and extracts), antimony trioxide, titanium dioxide, silica (crystalline), di(2-ethylhexyl) phthalate, ethylene thiourea, acrylonitrile, 1,3-butadiene, epichlorohydrin, toluenediisocyanate, tetrafluoroethylene, ethylbenzene, formaldehyde, furfuryl alcohol, glass fibers, methyl isobutyl ketone, nickel (metallic and compounds), lead and lead compounds which are known to the State of California to cause cancer; and 1,3-butadiene, epichlorohydrin, di(2-ethylhexyl)phthalate, di-isodecyl phthalate, ethylene thiourea, methyl isobutyl ketone, methanol, toluene, lead and lead compounds which are known to the State of California to cause birth defects and other reproductive harm. For more information go to www.P65Warnings.ca.gov.

Rotary O-Ring Seal Gland Dimensions (Continued)

O-Ring Size Parker No. 2-	Dimensions			Mean O.D. (Ref)	B OD (Shaft) +.000 -.001	A-1 Groove Dia. (Gland) +.003 -.000	D Throat Dia. +.003 -.000	G Groove Width +.004 -.000		
	I.D.	±	W							
154	3.737	.028	↑	3.943	3.739	3.933	3.751	↑		
155	3.987	.028		4.193	3.989	4.183	4.001			
156	4.237	.030		4.443	4.239	4.433	4.251			
157	4.487	.030		.103	4.693	4.489	4.683		4.501	.108
158	4.737	.030		±.003	4.943	4.739	4.933		4.751	
159	4.987	.035	↓	5.193	4.989	5.183	5.001	↓		
160	5.237	.035		5.443	5.239	5.433	5.251			
161	5.487	.035		5.693	5.489	5.683	5.501			
162	5.737	.035		5.943	5.739	5.933	5.751			
163	5.987	.035		6.193	5.989	6.183	6.001			
201	.171	.005		↑	.449	.173	.439		.189	↑
202	.234	.005			.512	.236	.502		.252	
203	.296	.005	.574		.298	.564	.314			
204	.359	.005	.637		.361	.627	.377			
205	.421	.005	.699		.423	.689	.439			
206	.484	.005	.762		.486	.752	.502			
207	.546	.007	.824		.548	.814	.564			
208	.609	.009	.887		.611	.877	.627			
209	.671	.009	.949		.673	.939	.689			
210	.734	.010	1.012		.736	1.002	.752			
211	.796	.010	↓	1.074	.798	1.064	.814	↓		
212	.859	.010		1.137	.861	1.127	.877			
213	.921	.010		1.199	.923	1.189	.939			
214	.984	.010		.139	1.262	.986	1.252		1.002	.144
215	1.046	.010		±.004	1.324	1.048	1.314		1.064	
216	1.109	.012	↓	1.387	1.111	1.377	1.127	↓		
217	1.171	.012		1.449	1.173	1.439	1.189			
218	1.234	.012		1.512	1.236	1.502	1.252			
219	1.296	.012		1.574	1.298	1.564	1.314			
220	1.359	.012		1.637	1.361	1.627	1.377			
221	1.421	.012		1.699	1.423	1.689	1.439			
222	1.484	.015		1.762	1.486	1.752	1.502			
223	1.609	.015		1.887	1.611	1.877	1.627			
224	1.734	.015		2.012	1.736	2.002	1.752			
225	1.859	.018		2.137	1.861	2.127	1.877			
226	1.984	.018	↓	2.262	1.986	2.252	2.002	↓		
227	2.109	.018		2.387	2.111	2.377	2.127			
228	2.234	.020		2.512	2.236	2.502	2.252			
229	2.359	.020		2.637	2.361	2.627	2.377			
230	2.484	.020		2.762	2.486	2.752	2.502			
231	2.609	.020		2.887	2.611	2.877	2.627			
232	2.734	.024		3.012	2.736	3.002	2.752			
233	2.859	.024		3.137	2.861	3.127	2.877			
234	2.984	.024		3.262	2.986	3.252	3.002			
235	3.109	.024		3.387	3.111	3.377	3.127			
236	3.234	.024		3.512	3.236	3.502	3.252			
237	3.359	.024		3.637	3.361	3.627	3.377			

† For pressures over 55.2 Bar (800 psi), consult Design Chart 5-4 and the design sections of this Handbook.

Design Table 5-4: Rotary O-Ring Seal Gland Dimensions

WARNING: These products can expose you to chemicals including carbon black (airborne and extracts), antimony trioxide, titanium dioxide, silica (crystalline), di(2-ethylhexyl) phthalate, ethylene thiourea, acrylonitrile, 1,3-butadiene, epichlorohydrin, toluenediisocyanate, tetrafluoroethylene, ethylbenzene, formaldehyde, furfuryl alcohol, glass fibers, methyl isobutyl ketone, nickel (metallic and compounds), lead and lead compounds which are known to the State of California to cause cancer; and 1,3-butadiene, epichlorohydrin, di(2-ethylhexyl)phthalate, di-isodecyl phthalate, ethylene thiourea, methyl isobutyl ketone, methanol, toluene, lead and lead compounds which are known to the State of California to cause birth defects and other reproductive harm. For more information go to www.P65Warnings.ca.gov.

Rotary O-Ring Seal Gland Dimensions (Continued)

O-Ring Size Parker No. 2-	Dimensions			Mean O.D. (Ref)	B OD (Shaft) +.000 -.001	A-1 Groove Dia. (Gland) +.003 -.000	D Throat Dia. +.003 -.000	G Groove Width +.004 -.000		
	I.D.	±	W							
238	3.484	.024	↑	3.762	3.486	3.752	3.502	↑		
239	3.609	.028		3.887	3.611	3.877	3.627			
240	3.734	.028		4.012	3.736	4.002	3.752			
241	3.859	.028		4.137	3.861	4.127	3.877			
242	3.984	.028		4.262	3.986	4.252	4.002			
243	4.109	.028		4.387	4.111	4.377	4.127			
244	4.234	.030		4.512	4.236	4.502	4.252			
245	4.359	.030		4.637	4.361	4.627	4.377			
246	4.484	.030		.139	4.762	4.486	4.752		4.502	.144
247	4.609	.030		±.004	4.887	4.611	4.877		4.627	
248	4.734	.030	↓	5.012	4.736	5.002	4.752	↓		
249	4.859	.035		5.137	4.861	5.127	4.877			
250	4.984	.035		5.262	4.986	5.252	5.002			
251	5.109	.035		5.387	5.111	5.377	5.127			
252	5.234	.035		5.512	5.236	5.502	5.252			
253	5.359	.035		5.637	5.361	5.627	5.377			
254	5.484	.035		5.762	5.486	5.752	5.502			
255	5.609	.035		5.887	5.611	5.877	5.627			
256	5.734	.035		6.012	5.736	6.002	5.752			
257	5.859	.035		6.137	5.861	6.127	5.877			
258	5.984	.035	6.262	5.986	6.252	6.002				

† For pressures over 55.2 Bar (800 psi), consult Design Chart 5-4 and the design sections of this Handbook.

Design Table 5-4: Rotary O-Ring Seal Gland Dimensions

WARNING: These products can expose you to chemicals including carbon black (airborne and extracts), antimony trioxide, titanium dioxide, silica (crystalline), di(2-ethylhexyl) phthalate, ethylene thiourea, acrylonitrile, 1,3-butadiene, epichlorohydrin, toluenediisocyanate, tetrafluoroethylene, ethylbenzene, formaldehyde, furfuryl alcohol, glass fibers, methyl isobutyl ketone, nickel (metallic and compounds), lead and lead compounds which are known to the State of California to cause cancer; and 1,3-butadiene, epichlorohydrin, di(2-ethylhexyl)phthalate, di-isodecyl phthalate, ethylene thiourea, methyl isobutyl ketone, methanol, toluene, lead and lead compounds which are known to the State of California to cause birth defects and other reproductive harm. For more information go to www.P65Warnings.ca.gov.

5.32 Dynamic Vacuum Sealing

There is very little data available on dynamic vacuum seals, but reasonably low leak rates have been reported using two O-rings seals designed according to the standard radial dynamic design dimensions for reciprocating seals which are shown in Design Chart 5-5.

In sealing gases and vacuum, it is quite feasible to use two O-ring seals in separate grooves. (In reciprocating hydraulic applications, however, such redundant seals are not recommended because of the danger of creating a pressure trap between the two seals.)

For Reciprocating Vacuum Packing Glands

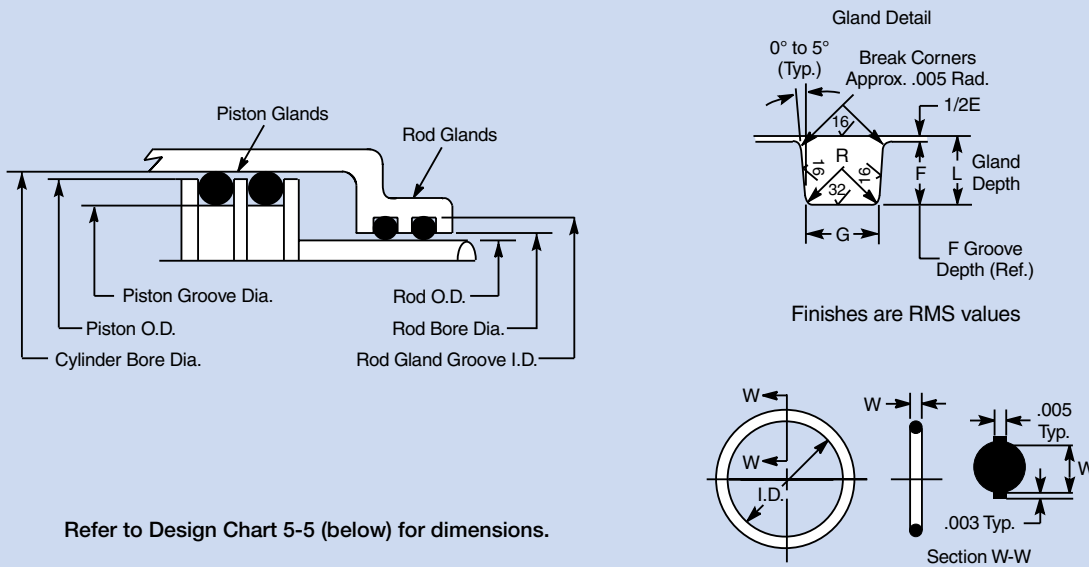

Reciprocating Vacuum Packing Glands

O-Ring Size AS568A-	W Cross-Section		L Gland Depth	Squeeze		E Diametral Clearance	G Groove Width	R Groove Radius	Max.* Eccentricity
	Nominal	Actual		Actual	%				
006 through 012	1/16	.070 ±.003	.055 to .057	.010 to .018	15 to 25	.002 to .005	.093 to .098	.005 to .015	.002
104 through 116	3/32	.103 ±.003	.088 to .090	.010 to .018	10 to 17	.002 to .005	.140 to .145	.005 to .015	.002
201 through 222	1/8	.139 ±.004	.121 to .123	.012 to .022	9 to 16	.003 to .006	.187 to .192	.010 to .025	.003
309 through 349	3/16	.210 ±.005	.185 to .188	.017 to .030	8 to 14	.003 to .006	.281 to .286	.020 to .035	.004
425 through 460	1/4	.275 ±.006	.237 to .240	.029 to .044	11 to 16	.004 to .007	.375 to .380	.020 to .035	.005

*Total indicator reading between groove and adjacent bearing surface.

Design Chart 5-5: Design Chart for Reciprocating Vacuum Packing Glands

WARNING: These products can expose you to chemicals including carbon black (airborne and extracts), antimony trioxide, titanium dioxide, silica (crystalline), di(2-ethylhexyl) phthalate, ethylene thiourea, acrylonitrile, 1,3-butadiene, epichlorohydrin, toluenediisocyanate, tetrafluoroethylene, ethylbenzene, formaldehyde, furfuryl alcohol, glass fibers, methyl isobutyl ketone, nickel (metallic and compounds), lead and lead compounds which are known to the State of California to cause cancer; and 1,3-butadiene, epichlorohydrin, di(2-ethylhexyl)phthalate, di-isodecyl phthalate, ethylene thiourea, methyl isobutyl ketone, methanol, toluene, lead and lead compounds which are known to the State of California to cause birth defects and other reproductive harm. For more information go to www.P65Warnings.ca.gov.

Section VI – Back-Up Rings

6.1 Introduction	6-2
6.2 Anti-Extrusion Device Design Hints	6-2
6.3 Parbak® Elastomer Back-Up Rings	6-2
6.4 Other Back-Up Ring Materials	6-2
6.4.1 Polytetrafluoroethylene (PTFE) Back-Up Rings	6-2
6.4.2 Metal Non-Extrusion Rings	6-3
6.4.3 Leather Back-Up Rings	6-3
6.5 Parbak Compound Information	6-3
6.6 Parker Parbak 8-Series Dimensions	6-3

Parbak® is a registered trademark of Parker Hannifin Corporation.

 **WARNING:** These products can expose you to chemicals including carbon black (airborne and extracts), antimony trioxide, titanium dioxide, silica (crystalline), di(2-ethylhexyl) phthalate, ethylene thiourea, acrylonitrile, 1,3-butadiene, epichlorohydrin, toluenediisocyanate, tetrafluoroethylene, ethylbenzene, formaldehyde, furfuryl alcohol, glass fibers, methyl isobutyl ketone, nickel (metallic and compounds), lead and lead compounds which are known to the State of California to cause cancer; and 1,3-butadiene, epichlorohydrin, di(2-ethylhexyl)phthalate, di-isodecyl phthalate, ethylene thiourea, methyl isobutyl ketone, methanol, toluene, lead and lead compounds which are known to the State of California to cause birth defects and other reproductive harm. For more information go to www.P65Warnings.ca.gov.

Back-Up Rings

6.1 Introduction

Parker's Parbak® back-up rings help prevent extrusion in high pressure service and compensate for loose fitting parts. The use of loose fitting parts makes for cost reduction in the machining of unit components.

The 90 durometer curve in Figure 3-5 may be used to find the maximum recommended clearance at a given pressure for temperatures up to 74°C (165°F) when standard Parbak rings in Parker's N1444-90 nitrile compound are used to protect an O-ring from extrusion. In using these curves, it must be remembered that cylinders tend to expand when pressurized. The clearance that the Parbak will see is the clearance between the piston and the expanded cylinder.

The extrusion curves can be used in two different ways to reap the benefits of Parbaks, depending on the application. In low pressure seals, the curves will indicate wider permissible clearances than those given in the design charts. Tolerances on these can be opened up until they permit these larger clearances to occur, resulting in substantial machining economies. When tolerances are increased, however, one must check to be sure that squeeze values do not become too high or too low.

In high pressure applications, the curves will indicate whether adding a Parbak will permit the use of standard catalog gland dimensions or whether the clearance will need to be reduced further.

In double acting seal assemblies, a Parbak is required on both sides of the O-ring. It is cheap insurance to use two Parbaks even in single acting installations. At assembly, it is too easy to place a single Parbak on the wrong side of the O-ring. By specifying one on each side of the O-ring, there will be one on the low pressure side, where it is needed, and the extra Parbak does no harm.

Unlike many PTFE back-up rings, Parbak rings are continuous; they do not have a cut because they can be stretched over the end of a piston during assembly. Hence they contact the mating O-ring uniformly, and do not cause localized wear spots.

Parbaks are contoured on one face to minimize distortion of the O-ring when under pressure, yet the orientation of the contoured face is immaterial to the proper function of the part because it is flexible.

Parbaks are quick and easy to assemble, minimizing assembly costs, and they cannot fall out of the O-ring groove. Besides their advantages as anti-extrusion devices, Parbak rings help trap lubricant, preserving the O-ring and reducing friction.

The standard sizes are listed in Table 6-1. Refer to the appropriate Design Chart for recommended groove width. Special sizes are also made to order.

Parbak® is a registered trademark of Parker Hannifin Corporation.

6.2 Anti-Extrusion Device Design Hints

1. Wherever possible use two back-up rings, one on each side of the O-ring.
2. If only one back-up ring is used, the O-ring should be placed between it and the source of pressure.
3. Parbaks should be installed with the contoured face against the O-ring, but reversal does no harm.
4. Parker's Parbaks will not "collapse" or cold flow if used with proper groove designs.
5. Use groove widths given in the Static O-Ring Sealing and Dynamic O-Ring Sealing Sections.

6.3 Parbak Elastomer Back-Up Rings

Hard rubber back-up rings combine most of the best features of both leather and PTFE anti-extrusion devices. Although no industrial or military standards have been issued for rubber back-up rings, they have been in use for a number of years. These are special devices designed to satisfy a specific problem.

Parbaks in Parker Seal Group's standard nitrile compound, N1444-90, are generally usable through a temperature range of -40°C to 121°C (-40° to 250°F). Hardening of this material due to high or low temperatures often improves performance as a back-up ring.

Features of Parbak Rings

1. Elastic memory permits Parbak rings to be stretched into place for assembly without preconditioning or cutting.
2. Continuous construction prevents damage to the O-ring seal.
3. Lubrication is enhanced by rubber which absorbs system fluid and does not plate out on rubbing surfaces.

6.4 Other Back-Up Ring Materials

6.4.1 Polytetrafluoroethylene (PTFE) Back-Up Rings

Anti-extrusion rings made from tetrafluoroethylene are impervious to oils and solvents. Acids and inorganic salts have very little effect on PTFE resin. In addition to its good chemical resistance, PTFE may be used over a wide temperature range, from below -73°C to over 204°C (-100°F to over 400°F). Thus, PTFE back-up rings may be used with most elastomeric O-ring seals. For installation, PTFE back-up rings are supplied either scarf or spiral cut as shown in Figure 6-1. These discontinuities may contribute to seal damage due to biting and pinching. PTFE can also impair seal lubrication by plating rubbing surfaces with PTFE resin to which lubricating oil will not adhere.



WARNING: These products can expose you to chemicals including carbon black (airborne and extracts), antimony trioxide, titanium dioxide, silica (crystalline), di(2-ethylhexyl) phthalate, ethylene thiourea, acrylonitrile, 1,3-butadiene, epichlorohydrin, toluenediisocyanate, tetrafluoroethylene, ethylbenzene, formaldehyde, furfuryl alcohol, glass fibers, methyl isobutyl ketone, nickel (metallic and compounds), lead and lead compounds which are known to the State of California to cause cancer; and 1,3-butadiene, epichlorohydrin, di(2-ethylhexyl)phthalate, di-isodecyl phthalate, ethylene thiourea, methyl isobutyl ketone, methanol, toluene, lead and lead compounds which are known to the State of California to cause birth defects and other reproductive harm. For more information go to www.P65Warnings.ca.gov.

6.4.2 Metal Non-Extrusion Rings

In most cases it will be impracticable and unnecessary (under 1380 bar 20,000 psi) to design bolt and rivet seal glands that are self-tightening, i.e., tending to reduce rather than increase seal extrusion clearance as pressure increases. Adequate gland volume should be allowed, in keeping with assembly tolerances. Two designs that have been helpful in alleviating extrusion in ultra high pressure applications are shown in Figure 6-2.

6.4.3 Leather Back-Up Rings

Leather was a standard back-up ring material for many years. Manufacturers of these rings developed special processing methods and impregnations for different types of applications. Standard sizes were established for use with all standard O-rings. If there is any question concerning the suitability of leather for the application, consult the supplier. Leather back-up rings are manufactured as continuous rings and in most cases must be stretched during installation. Less damage will be incurred to the back-up rings if they are soaked in oil before installation. After installation, a short exposure to heat will shrink the leather rings back to size. Leather back-up rings should never be cut to facilitate installation.

6.5 Parbak Compound Information

Some back-up ring materials tend to leave deposits in the micro fine grooves of the surface on which they rub. An ultra smooth, wax-like surface results. Because an O-ring may wipe all lubrication from such a surface, reverse stroking is dry and greatly reduces seal life. Parbaks of N1444-90 and other rubber compounds solve this problem. They do not leave a deposit on the metal surface, thus lubrication remains.

The standard compound for Parbaks is N1444-90. Careful engineering and research has produced N1444-90 which has the best combination of characteristics for the majority of back-up ring installations — broad temperature range, proper hardness, long sealing life, and resistance to a great number of fluids. It is resistant to nearly all hydraulic fluids except certain non-flammable types such as Skydrol. It is also resistant to air and water.

Functional tests have proven that millions of cycles can be obtained with Parbaks, showing their tremendous superiority over the older types of back-up rings.

In addition to N1444-90, Parker Seal has developed other compounds for installations requiring special characteristics. Present capabilities include service at continuous temperatures as high as 204°C (400°F).

Additional assistance in specifying and using Parbak rings is available upon request by calling your Parker Seal representative.

6.6 Parker Parbak 8-Series Dimensions

Parbaks will stretch up to 50%, and are quickly and easily installed. Advantages of the contour design are obtained regardless of how Parbaks are installed. They may be installed with the concave face in either direction, toward or away from the O-ring.

Table 6-1 provides Parker Parbak 8-Series Dimensions.

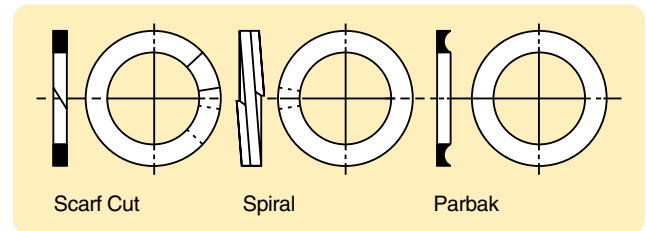

Figure 6-1: Typical Back-Up Rings

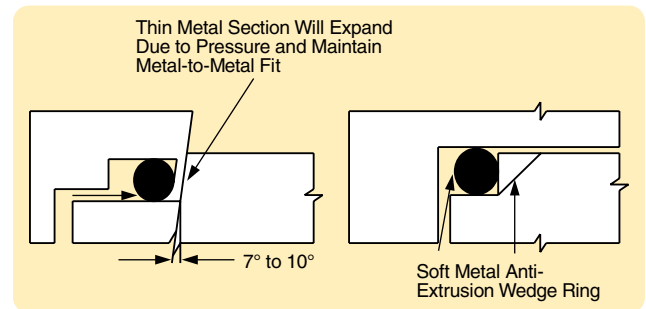
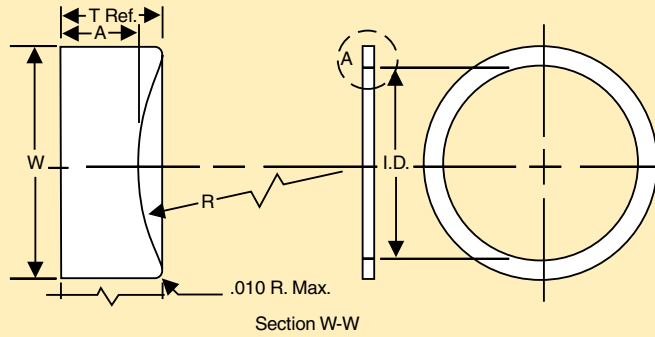

Figure 6-2: Clearance Control for High Pressure Seals

WARNING: These products can expose you to chemicals including carbon black (airborne and extracts), antimony trioxide, titanium dioxide, silica (crystalline), di(2-ethylhexyl) phthalate, ethylene thiourea, acrylonitrile, 1,3-butadiene, epichlorohydrin, toluenediisocyanate, tetrafluoroethylene, ethylbenzene, formaldehyde, furfuryl alcohol, glass fibers, methyl isobutyl ketone, nickel (metallic and compounds), lead and lead compounds which are known to the State of California to cause cancer; and 1,3-butadiene, epichlorohydrin, di(2-ethylhexyl)phthalate, di-isodecyl phthalate, ethylene thiourea, methyl isobutyl ketone, methanol, toluene, lead and lead compounds which are known to the State of California to cause birth defects and other reproductive harm. For more information go to www.P65Warnings.ca.gov.

**Parker Parbak
8-Series Dimensions**



Parker Parbaks were developed primarily for service in petroleum based hydraulic fluids, at -4°C to 121°C (-40°F to 250°F). Parker's standard Parbak compound N1444-90, provides the maximum benefits in back-up ring service. Compounds for use in other fluids and for temperatures up to 204°C (400°F) are available upon request.

Parbaks will stretch up to 50%, and are quickly and easily installed. Advantages of the contour design are obtained regardless of how Parbaks are installed — they may be installed with the concave face in either direction, toward or away from the O-ring.

Parker Parbak 8-Series Dimensions

Dash No.	I.D. (in.)	Tol. ±	R ±.010	T (Ref.)	A (in.)	Tol. ±	W (in.)	Tol. ±	Dash No.	I.D. (in.)	Tol. ±	R ±.010	T (Ref.)	A (in.)	Tol. ±	W (in.)	Tol. ±
004	.096	.005	.087	.049	.045	.003	.053	.003	041	3.018	.024	.087	.049	.045	.003	.053	.003
005	.127	↑	↑	↑	↑	↑	↑	↑	042	3.268	.024	↑	↑	↑	↑	↑	↑
006	.140	↑	↑	↑	↑	↑	↑	↑	043	3.518	.024	↑	↑	↑	↑	↑	↑
007	.171	↑	↑	↑	↑	↑	↑	↑	044	3.768	.027	↑	↑	↑	↑	↑	↑
008	.202	↑	↑	↑	↑	↑	↑	↑	045	4.018	.027	↑	↑	↑	↑	↑	↑
009	.234	↑	↑	↑	↑	↑	↑	↑	046	4.268	.030	↑	↑	↑	↑	↑	↑
010	.265	↑	↑	↑	↑	↑	↑	↑	047	4.518	.030	↑	↑	↑	↑	↑	↑
011	.327	↑	↑	↑	↑	↑	↑	↑	048	4.768	.030	↑	↑	↑	↑	↑	↑
012	.390	↓	↓	↓	↓	↓	↓	↓	049	5.018	.037	↓	↓	↓	↓	↓	↓
013	.455	.005	↓	↓	↓	↓	↓	↓	050	5.268	.037	.087	.049	↓	↓	.053	↓
014	.518	.005	↓	↓	↓	↓	↓	↓	102	.077	.005	.129	.053	↓	↓	.086	↓
015	.580	.007	↓	↓	↓	↓	↓	↓	103	.109	↑	↑	↑	↑	↑	↑	↑
016	.643	.009	↓	↓	↓	↓	↓	↓	104	.140	↑	↑	↑	↑	↑	↑	↑
017	.705	↑	↑	↑	↑	↑	↑	↑	105	.171	↑	↑	↑	↑	↑	↑	↑
018	.768	↑	↑	↑	↑	↑	↑	↑	106	.202	↑	↑	↑	↑	↑	↑	↑
019	.830	↓	↓	↓	↓	↓	↓	↓	107	.234	↓	↓	↓	↓	↓	↓	↓
020	.893	.009	↓	↓	↓	↓	↓	↓	108	.265	↓	↓	↓	↓	↓	↓	↓
021	.955	.010	↓	↓	↓	↓	↓	↓	109	.327	↓	↓	↓	↓	↓	↓	↓
022	1.018	.010	↓	↓	↓	↓	↓	↓	110	.390	↓	↓	↓	↓	↓	↓	↓
023	1.080	.010	↓	↓	↓	↓	↓	↓	111	.452	↓	↓	↓	↓	↓	↓	↓
024	1.143	.010	↓	↓	↓	↓	↓	↓	112	.515	.005	↓	↓	↓	↓	↓	↓
025	1.205	.011	↓	↓	↓	↓	↓	↓	113	.577	.007	↓	↓	↓	↓	↓	↓
026	1.268	.011	↓	↓	↓	↓	↓	↓	114	.640	.009	↓	↓	↓	↓	↓	↓
027	1.330	.011	↓	↓	↓	↓	↓	↓	115	.702	.009	↓	↓	↓	↓	↓	↓
028	1.393	.013	↓	↓	↓	↓	↓	↓	116	.765	.009	↓	↓	↓	↓	↓	↓
029	1.518	.013	↓	↓	↓	↓	↓	↓	117	.831	.010	↓	↓	↓	↓	↓	↓
030	1.643	.013	↓	↓	↓	↓	↓	↓	118	.893	↑	↑	↑	↑	↑	↑	↑
031	1.768	.015	↓	↓	↓	↓	↓	↓	119	.956	↑	↑	↑	↑	↑	↑	↑
032	1.893	.015	↓	↓	↓	↓	↓	↓	120	1.018	↑	↑	↑	↑	↑	↑	↑
033	2.018	.018	↓	↓	↓	↓	↓	↓	121	1.081	↓	↓	↓	↓	↓	↓	↓
034	2.143	↑	↑	↑	↑	↑	↑	↑	122	1.143	.010	↓	↓	↓	↓	↓	↓
035	2.268	↑	↑	↑	↑	↑	↑	↑	123	1.206	.012	↓	↓	↓	↓	↓	↓
036	2.393	↓	↓	↓	↓	↓	↓	↓	124	1.268	↑	↑	↑	↑	↑	↑	↑
037	2.518	.018	↓	↓	↓	↓	↓	↓	125	1.331	↑	↑	↑	↑	↑	↑	↑
038	2.643	.020	↓	↓	↓	↓	↓	↓	126	1.393	↑	↑	↑	↑	↑	↑	↑
039	2.768	.020	↓	↓	↓	↓	↓	↓	127	1.456	↓	↓	↓	↓	↓	↓	↓
040	2.893	.020	.087	.049	.045	.003	.053	.003	128	1.518	.012	.129	.053	.045	.003	.086	.003

- Notes: 1. Parbak sizes are designed to correspond with the Parker 2-xxx, 3-xxx and AS568A series O-ring with which they are used.
2. Complete call-out consists of the digit 8, the dash number for the size wanted and the rubber material. Example: N1444-90 8-009.

Table 6-1: Parker Parbak 8-Series Dimensions

WARNING: These products can expose you to chemicals including carbon black (airborne and extracts), antimony trioxide, titanium dioxide, silica (crystalline), di(2-ethylhexyl) phthalate, ethylene thiourea, acrylonitrile, 1,3-butadiene, epichlorohydrin, toluenediisocyanate, tetrafluoroethylene, ethylbenzene, formaldehyde, furfuryl alcohol, glass fibers, methyl isobutyl ketone, nickel (metallic and compounds), lead and lead compounds which are known to the State of California to cause cancer; and 1,3-butadiene, epichlorohydrin, di(2-ethylhexyl)phthalate, di-isodecyl phthalate, ethylene thiourea, methyl isobutyl ketone, methanol, toluene, lead and lead compounds which are known to the State of California to cause birth defects and other reproductive harm. For more information go to www.P65Warnings.ca.gov.

Parker Parbak 8-Series Dimensions (Continued)																	
Dash No.	I.D. (in.)	Tol. ±	R ±.010	T (Ref.)	A (in.)	Tol. ±	W (in.)	Tol. ±	Dash No.	I.D. (in.)	Tol. ±	R ±.010	T (Ref.)	A (in.)	Tol. ±	W (in.)	Tol. ±
129	1.581	.015	.129	.053	.045	.003	.086	.003	206	.518	.005	.174	.050	.040	.003	.118	.004
130	1.643	↑	↑	↑	↑	↑	↑	↑	207	.580	.007	↑	↑	↑	↑	↑	↑
131	1.706	↑	↑	↑	↑	↑	↑	↑	208	.643	.009	↑	↑	↑	↑	↑	↑
132	1.768	↑	↑	↑	↑	↑	↑	↑	209	.705	.009	↑	↑	↑	↑	↑	↑
133	1.831	↓	↑	↑	↑	↑	↑	↑	210	.766	.010	↑	↑	↑	↑	↑	↑
134	1.893	.015	↑	↑	↑	↑	↑	↑	211	.828	↑	↑	↑	↑	↑	↑	↑
135	1.956	.017	↑	↑	↑	↑	↑	↑	212	.891	↑	↑	↑	↑	↑	↑	↑
136	2.018	↑	↑	↑	↑	↑	↑	↑	213	.953	↓	↑	↑	↑	↑	↑	↑
137	2.081	↓	↑	↑	↑	↑	↑	↑	214	1.016	.010	↑	↑	↑	↑	↑	↑
138	2.143	.017	↑	↑	↑	↑	↑	↑	215	1.078	.010	↑	↑	↑	↑	↑	↑
139	2.206	.017	↑	↑	↑	↑	↑	↑	216	1.141	.012	↑	↑	↑	↑	↑	↑
140	2.268	.017	↑	↑	↑	↑	↑	↑	217	1.203	↑	↑	↑	↑	↑	↑	↑
141	2.331	.020	↑	↑	↑	↑	↑	↑	218	1.266	↑	↑	↑	↑	↑	↑	↑
142	2.393	↑	↑	↑	↑	↑	↑	↑	219	1.334	↓	↑	↑	↑	↑	↑	↑
143	2.456	↑	↑	↑	↑	↑	↑	↑	220	1.397	↓	↑	↑	↑	↑	↑	↑
144	2.518	↑	↑	↑	↑	↑	↑	↑	221	1.459	.012	↑	↑	↑	↑	↑	↑
145	2.581	↓	↑	↑	↑	↑	↑	↑	222	1.522	.015	↑	↑	↑	↑	↑	↑
146	2.643	.020	↑	↑	↑	↑	↑	↑	223	1.647	.015	↑	↑	↑	↑	↑	↑
147	2.706	.022	↑	↑	↑	↑	↑	↑	224	1.772	.015	↑	↑	↑	↑	↑	↑
148	2.768	↑	↑	↑	↑	↑	↑	↑	225	1.897	.018	↑	↑	↑	↑	↑	↑
149	2.831	↓	↑	↑	↑	↑	↑	↑	226	2.022	.018	↑	↑	↑	↑	↑	↑
150	2.893	.022	↑	↑	↑	↑	↑	↑	227	2.147	.018	↑	↑	↑	↑	↑	↑
151	3.018	.024	↑	↑	↑	↑	↑	↑	228	2.272	.020	↑	↑	↑	↑	↑	↑
152	3.268	.024	↑	↑	↑	↑	↑	↑	229	2.397	.020	↑	↑	↑	↑	↑	↑
153	3.518	.024	↑	↑	↑	↑	↑	↑	230	2.522	.020	↑	↑	↑	↑	↑	↑
154	3.768	.028	↑	↑	↑	↑	↑	↑	231	2.631	.020	↑	↑	↑	↑	↑	↑
155	4.018	.028	↑	↑	↑	↑	↑	↑	232	2.756	.024	↑	↑	↑	↑	↑	↑
156	4.268	.030	↑	↑	↑	↑	↑	↑	233	2.881	↑	↑	↑	↑	↑	↑	↑
157	4.518	.030	↑	↑	↑	↑	↑	↑	234	3.006	↑	↑	↑	↑	↑	↑	↑
158	4.768	.030	↑	↑	↑	↑	↑	↑	235	3.131	↑	↑	↑	↑	↑	↑	↑
159	5.018	.035	↑	↑	↑	↑	↑	↑	236	3.256	↑	↑	↑	↑	↑	↑	↑
160	5.268	↑	↑	↑	↑	↑	↑	↑	237	3.381	↓	↑	↑	↑	↑	↑	↑
161	5.518	↑	↑	↑	↑	↑	↑	↑	238	3.506	.024	↑	↑	↑	↑	↑	↑
162	5.768	↓	↑	↑	↑	↑	↑	↑	239	3.631	.028	↑	↑	↑	↑	↑	↑
163	6.018	.035	↑	↑	↑	↑	↑	↑	240	3.756	↑	↑	↑	↑	↑	↑	↑
164	6.268	.040	↑	↑	↑	↑	↑	↑	241	3.881	↑	↑	↑	↑	↑	↑	↑
165	6.518	↑	↑	↑	↑	↑	↑	↑	242	4.006	↓	↑	↑	↑	↑	↑	↑
166	6.768	↓	↑	↑	↑	↑	↑	↑	243	4.131	.028	↑	↑	↑	↑	↑	↑
167	7.018	.040	↑	↑	↑	↑	↑	↑	244	4.256	.030	↑	↑	↑	↑	↑	↑
168	7.268	.045	↑	↑	↑	↑	↑	↑	245	4.381	↑	↑	↑	↑	↑	↑	↑
169	7.518	↑	↑	↑	↑	↑	↑	↑	246	4.506	↑	↑	↑	↑	↑	↑	↑
170	7.768	↓	↑	↑	↑	↑	↑	↑	247	4.631	↓	↑	↑	↑	↑	↑	↑
171	8.018	.045	↑	↑	↑	↑	↑	↑	248	4.768	.030	↑	↑	↑	↑	↑	↑
172	8.268	.050	↑	↑	↑	↑	↑	↑	249	4.893	.035	↑	↑	↑	↑	↑	↑
173	8.518	↑	↑	↑	↑	↑	↑	↑	250	5.018	↑	↑	↑	↑	↑	↑	↑
174	8.768	↓	↑	↑	↑	↑	↑	↑	251	5.143	↑	↑	↑	↑	↑	↑	↑
175	9.018	.050	↑	↑	↑	↑	↑	↑	252	5.268	↑	↑	↑	↑	↑	↑	↑
176	9.268	.055	↑	↑	↑	↑	↑	↑	253	5.393	↑	↑	↑	↑	↑	↑	↑
177	9.518	.055	↓	↓	↓	↓	↓	↓	254	5.518	↑	↑	↑	↑	↑	↑	↑
178	9.768	.055	.129	.053	.045	.003	.086	.003	255	5.643	↑	↑	↑	↑	↑	↑	↑
201	.202	.005	.174	.050	.040	.003	.118	.004	256	5.768	↓	↓	↓	↓	↓	↓	↓
202	.265	↑	↑	↑	↑	↓	↑	↑	257	5.893	↓	↓	↓	↓	↓	↓	↓
203	.327	↑	↑	↑	↑	↓	↑	↑	258	6.018	.035	↓	↓	↓	↓	↓	↓
204	.390	↓	↓	↓	↓	↓	↓	↓	259	6.268	.040	↓	↓	↓	↓	↓	↓
205	.455	.005	.174	.050	.040	.003	.118	.004	260	6.518	.040	↓	↓	↓	↓	↓	↓
									261	6.768	.040	.174	.050	.040	.003	.118	.004

Notes: 1. Parbak sizes are designed to correspond with the Parker 2-xxx, 3-xxx and AS568A series O-ring with which they are used.
2. Complete call-out consists of the digit 8, the dash number for the size wanted and the rubber material. Example: N1444-90 8-009.

Table 6-1: Parker Parbak 8-Series Dimensions

WARNING: These products can expose you to chemicals including carbon black (airborne and extracts), antimony trioxide, titanium dioxide, silica (crystalline), di(2-ethylhexyl) phthalate, ethylene thiourea, acrylonitrile, 1,3-butadiene, epichlorohydrin, toluenediisocyanate, tetrafluoroethylene, ethylbenzene, formaldehyde, furfuryl alcohol, glass fibers, methyl isobutyl ketone, nickel (metallic and compounds), lead and lead compounds which are known to the State of California to cause cancer; and 1,3-butadiene, epichlorohydrin, di(2-ethylhexyl)phthalate, di-isodecyl phthalate, ethylene thiourea, methyl isobutyl ketone, methanol, toluene, lead and lead compounds which are known to the State of California to cause birth defects and other reproductive harm. For more information go to www.P65Warnings.ca.gov.

Parker Parbak 8-Series Dimensions (Continued)

Dash No.	I.D. (in.)	Tol. ±	R ±.010	T (Ref.)	A (in.)	Tol. ±	W (in.)	Tol. ±	Dash No.	I.D. (in.)	Tol. ±	R ±.010	T (Ref.)	A (in.)	Tol. ±	W (in.)	Tol. ±
262	7.018	.040	.174	.050	.040	.003	.118	.004	341	3.523	.024	.262	.076	.060	.004	.183	.005
263	7.268	.045	↑	↑	↑	↑	↑	↑	342	3.648	.028	↑	↑	↑	↑	↑	↑
264	7.518	↑	↑	↑	↑	↑	↑	↑	343	3.773	↑	↑	↑	↑	↑	↑	↑
265	7.768	↓	↑	↑	↑	↑	↑	↑	344	3.898	↑	↑	↑	↑	↑	↑	↑
266	8.018	.045	↑	↑	↑	↑	↑	↑	345	4.028	↓	↑	↑	↑	↑	↑	↑
267	8.268	.050	↑	↑	↑	↑	↑	↑	346	4.153	.028	↑	↑	↑	↑	↑	↑
268	8.518	↑	↑	↑	↑	↑	↑	↑	347	4.278	.030	↑	↑	↑	↑	↑	↑
269	8.768	↓	↑	↑	↑	↑	↑	↑	348	4.403	↑	↑	↑	↑	↑	↑	↑
270	9.018	.050	↑	↑	↑	↑	↑	↑	349	4.528	↑	↑	↑	↑	↑	↑	↑
271	9.268	.055	↑	↑	↑	↑	↑	↑	350	4.653	↑	↑	↑	↑	↑	↑	↑
272	9.518	.055	↑	↑	↑	↑	↑	↑	351	4.778	↓	↑	↑	↑	↑	↑	↑
273	9.768	.055	↑	↑	↑	↑	↑	↑	352	4.903	.030	↑	↑	↑	↑	↑	↑
274	10.018	.055	↑	↑	↑	↑	↑	↑	353	5.028	.037	↑	↑	↑	↑	↑	↑
275	10.518	.055	↑	↑	↑	↑	↑	↑	354	5.153	.037	↑	↑	↑	↑	↑	↑
276	11.018	.065	↑	↑	↑	↑	↑	↑	355	5.278	.037	↑	↑	↑	↑	↑	↑
277	11.518	↑	↑	↑	↑	↑	↑	↑	356	5.403	.037	↑	↑	↑	↑	↑	↑
278	12.018	↓	↑	↑	↑	↑	↑	↑	357	5.528	↑	↑	↑	↑	↑	↑	↑
279	13.018	↑	↑	↑	↑	↑	↑	↑	358	5.653	↑	↑	↑	↑	↑	↑	↑
280	14.018	↓	↑	↑	↑	↑	↑	↑	359	5.778	↓	↑	↑	↑	↑	↑	↑
281	15.018	.065	↑	↑	↑	↑	↑	↑	360	5.903	↓	↑	↑	↑	↑	↑	↑
282	15.989	.075	↓	↓	↓	↓	↓	↓	361	6.028	.037	↑	↑	↑	↑	↑	↑
283	16.989	.080	↓	↓	↓	↓	↓	↓	362	6.278	.040	↑	↑	↑	↑	↑	↑
284	17.989	.085	.174	.050	.040	.003	.118	.004	363	6.528	↑	↑	↑	↑	↑	↑	↑
309	.450	.005	.262	.076	.060	.004	.183	.005	364	6.778	↓	↑	↑	↑	↑	↑	↑
310	.513	.005	↑	↑	↑	↑	↑	↑	365	7.028	.040	↑	↑	↑	↑	↑	↑
311	.575	.007	↑	↑	↑	↑	↑	↑	366	7.278	.045	↑	↑	↑	↑	↑	↑
312	.638	.009	↑	↑	↑	↑	↑	↑	367	7.528	↑	↑	↑	↑	↑	↑	↑
313	.700	.009	↑	↑	↑	↑	↑	↑	368	7.778	↓	↑	↑	↑	↑	↑	↑
314	.763	.010	↑	↑	↑	↑	↑	↑	369	8.028	.045	↑	↑	↑	↑	↑	↑
315	.825	↑	↑	↑	↑	↑	↑	↑	370	8.278	.050	↑	↑	↑	↑	↑	↑
316	.888	↑	↑	↑	↑	↑	↑	↑	371	8.528	↑	↑	↑	↑	↑	↑	↑
317	.950	↓	↑	↑	↑	↑	↑	↑	372	8.778	↓	↑	↑	↑	↑	↑	↑
318	1.013	↓	↑	↑	↑	↑	↑	↑	373	9.028	.050	↑	↑	↑	↑	↑	↑
319	1.075	.010	↑	↑	↑	↑	↑	↑	374	9.278	.055	↑	↑	↑	↑	↑	↑
320	1.138	.012	↑	↑	↑	↑	↑	↑	375	9.528	↑	↑	↑	↑	↑	↑	↑
321	1.200	.012	↑	↑	↑	↑	↑	↑	376	9.778	↓	↑	↑	↑	↑	↑	↑
322	1.263	.012	↑	↑	↑	↑	↑	↑	377	10.028	.055	↑	↑	↑	↑	↑	↑
323	1.316	.012	↑	↑	↑	↑	↑	↑	378	10.528	.060	↑	↑	↑	↑	↑	↑
324	1.388	.012	↑	↑	↑	↑	↑	↑	379	11.028	.060	↑	↑	↑	↑	↑	↑
325	1.513	.015	↑	↑	↑	↑	↑	↑	380	11.528	.065	↑	↑	↑	↑	↑	↑
326	1.638	↑	↑	↑	↑	↑	↑	↑	381	12.028	.065	↑	↑	↑	↑	↑	↑
327	1.763	↓	↑	↑	↑	↑	↑	↑	382	13.028	.065	↑	↑	↑	↑	↑	↑
328	1.888	.015	↑	↑	↑	↑	↑	↑	383	14.028	.070	↑	↑	↑	↑	↑	↑
329	2.013	.018	↑	↑	↑	↑	↑	↑	384	15.028	.070	↑	↑	↑	↑	↑	↑
330	2.138	↑	↑	↑	↑	↑	↑	↑	385	16.008	.075	↑	↑	↑	↑	↑	↑
331	2.268	↓	↑	↑	↑	↑	↑	↑	386	17.008	.080	↑	↑	↑	↑	↑	↑
332	2.393	.018	↑	↑	↑	↑	↑	↑	387	18.008	.085	↑	↑	↑	↑	↑	↑
333	2.518	.020	↑	↑	↑	↑	↑	↑	388	19.006	.090	↑	↑	↑	↑	↑	↑
334	2.643	.020	↑	↑	↑	↑	↑	↑	389	20.006	.095	↑	↑	↑	↑	↑	↑
335	2.768	.020	↑	↑	↑	↑	↑	↑	390	21.006	.095	↑	↑	↑	↑	↑	↑
336	2.893	.020	↑	↑	↑	↑	↑	↑	391	22.006	.100	↑	↑	↑	↑	↑	↑
337	3.018	.024	↑	↑	↑	↑	↑	↑	392	22.993	.105	↑	↑	↑	↑	↑	↑
338	3.143	↑	↑	↑	↑	↑	↑	↑	393	23.993	.110	↑	↑	↑	↑	↑	↑
339	3.273	↓	↑	↑	↑	↑	↑	↑	394	24.993	.115	↑	↑	↑	↑	↑	↑
340	3.398	.024	.262	.076	.060	.004	.183	.005	395	25.993	.120	.262	.076	.060	.004	.183	.005

Notes: 1. Parbak sizes are designed to correspond with the Parker 2-xxx, 3-xxx and AS568A series O-ring with which they are used.
2. Complete call-out consists of the digit 8, the dash number for the size wanted and the rubber material. Example: N1444-90 8-009.

Table 6-1: Parker Parbak 8-Series Dimensions

WARNING: These products can expose you to chemicals including carbon black (airborne and extracts), antimony trioxide, titanium dioxide, silica (crystalline), di(2-ethylhexyl) phthalate, ethylene thiourea, acrylonitrile, 1,3-butadiene, epichlorohydrin, toluenediisocyanate, tetrafluoroethylene, ethylbenzene, formaldehyde, furfuryl alcohol, glass fibers, methyl isobutyl ketone, nickel (metallic and compounds), lead and lead compounds which are known to the State of California to cause cancer; and 1,3-butadiene, epichlorohydrin, di(2-ethylhexyl)phthalate, di-isodecyl phthalate, ethylene thiourea, methyl isobutyl ketone, methanol, toluene, lead and lead compounds which are known to the State of California to cause birth defects and other reproductive harm. For more information go to www.P65Warnings.ca.gov.

Parker Parbak 8-Series Dimensions (Continued)

Dash No.	I.D. (in.)	Tol. ±	R ±.010	T (Ref.)	A (in.)	Tol. ±	W (in.)	Tol. ±	Dash No.	I.D. (in.)	Tol. ±	R ±.010	T (Ref.)	A (in.)	Tol. ±	W (in.)	Tol. ±
425	4.551	.033	.344	.117	.096	.005	.236	.006	451	11.024	.060	.344	.117	.096	.005	.236	.006
426	4.676	↑	↑	↑	↑	↑	↑	↑	452	11.524	↑	↑	↑	↑	↑	↑	↑
427	4.801	↓	↑	↑	↑	↑	↑	↑	453	12.024	↑	↑	↑	↑	↑	↑	↑
428	4.926	.033	↑	↑	↑	↑	↑	↑	454	12.524	↓	↑	↑	↑	↑	↑	↑
429	5.051	.037	↑	↑	↑	↑	↑	↑	455	13.024	.060	↑	↑	↑	↑	↑	↑
430	5.176	↑	↑	↑	↑	↑	↑	↑	456	13.524	.070	↑	↑	↑	↑	↑	↑
431	5.301	↑	↑	↑	↑	↑	↑	↑	457	14.024	↑	↑	↑	↑	↑	↑	↑
432	5.426	↑	↑	↑	↑	↑	↑	↑	458	14.524	↑	↑	↑	↑	↑	↑	↑
433	5.551	↑	↑	↑	↑	↑	↑	↑	459	15.024	↓	↑	↑	↑	↑	↑	↑
434	5.676	↑	↑	↑	↑	↑	↑	↑	460	15.524	.070	↑	↑	↑	↑	↑	↑
435	5.801	↑	↑	↑	↑	↑	↑	↑	461	16.004	.075	↑	↑	↑	↑	↑	↑
436	5.926	↓	↑	↑	↑	↑	↑	↑	462	16.504	.075	↑	↑	↑	↑	↑	↑
437	6.051	.037	↑	↑	↑	↑	↑	↑	463	17.004	.080	↑	↑	↑	↑	↑	↑
438	6.274	.040	↑	↑	↑	↑	↑	↑	464	17.504	.085	↑	↑	↑	↑	↑	↑
439	6.524	↑	↑	↑	↑	↑	↑	↑	465	18.004	.085	↑	↑	↑	↑	↑	↑
440	6.774	↓	↑	↑	↑	↑	↑	↑	466	18.504	.085	↑	↑	↑	↑	↑	↑
441	7.024	.040	↑	↑	↑	↑	↑	↑	467	19.004	.090	↑	↑	↑	↑	↑	↑
442	7.274	.045	↑	↑	↑	↑	↑	↑	468	19.504	.090	↑	↑	↑	↑	↑	↑
443	7.524	↑	↑	↑	↑	↑	↑	↑	469	20.004	.095	↑	↑	↑	↑	↑	↑
444	7.774	↓	↑	↑	↑	↑	↑	↑	470	21.004	.095	↑	↑	↑	↑	↑	↑
445	8.024	.045	↑	↑	↑	↑	↑	↑	471	22.004	.100	↑	↑	↑	↑	↑	↑
446	8.524	.055	↑	↑	↑	↑	↑	↑	472	23.004	.105	↑	↑	↑	↑	↑	↑
447	9.024	↑	↑	↑	↑	↑	↑	↑	473	24.004	.110	↑	↑	↑	↑	↑	↑
448	9.524	↓	↑	↑	↑	↑	↑	↑	474	25.004	.115	↓	↓	↓	↓	↓	↓
449	10.024	.055	↓	↓	↓	↓	↓	↓	475	26.004	.120	.344	.117	.096	.005	.236	.006
450	10.524	.060	.344	.117	.096	.005	.236	.006									

- Notes: 1. Parbak sizes are designed to correspond with the Parker 2-xxx, 3-xxx and AS568A series O-ring with which they are used.
2. Complete call-out consists of the digit 8, the dash number for the size wanted and the rubber material. Example: N1444-90 8-009.

Table 6-1: Parker Parbak 8-Series Dimensions

WARNING: These products can expose you to chemicals including carbon black (airborne and extracts), antimony trioxide, titanium dioxide, silica (crystalline), di(2-ethylhexyl) phthalate, ethylene thiourea, acrylonitrile, 1,3-butadiene, epichlorohydrin, toluenediisocyanate, tetrafluoroethylene, ethylbenzene, formaldehyde, furfuryl alcohol, glass fibers, methyl isobutyl ketone, nickel (metallic and compounds), lead and lead compounds which are known to the State of California to cause cancer; and 1,3-butadiene, epichlorohydrin, di(2-ethylhexyl)phthalate, di-isodecyl phthalate, ethylene thiourea, methyl isobutyl ketone, methanol, toluene, lead and lead compounds which are known to the State of California to cause birth defects and other reproductive harm. For more information go to www.P65Warnings.ca.gov.

Back-Up Rings Cross Reference

This cross reference chart is to be utilized when considering the use of Parker's Parbak back-up rings as a retrofit for a

PTFE or leather back-up. Keep in mind, there **is not** a military specification that pertains to Parker's Parbak series back-up rings. This chart is intended as a retrofit guideline only.

Back-Up Rings Cross Reference

Parker N1444-90	MIL-W-5521 Leather	AS8791 PTFE	AS8791 PTFE	MIL-W-5521 Leather	Parker N1444-90	MIL-W-5521 Leather	AS8791 PTFE	AS8791 PTFE	MIL-W-5521 Leather
Parker Parbak Size No.*1	AN6244 ¹ AN6246 ¹	MS27595 ¹ MS28774 ² Dash No.	MS28782 ³ MS28783 ³	MS35803 ¹ Dash No.	Parker Parbak Size No.*1	AN6244 ¹ AN6246 ¹	MS27595 ¹ MS28774 ² Dash No.	MS28782 ³ MS28783 ³	MS35803 ¹ Dash No.
8-004		-004			8-130		-130		
8-005		-005			8-131		-131		
8-006	AN6246-1	-006	MS28782-1	-6	8-132		-132		
8-007	AN6246-2	-007	MS28782-2	-7	8-133		-133		
8-008	AN6246-3	-008	MS28782-3	-8	8-134		-134		
8-009	AN6246-4	-009	MS28782-4	-9	8-135		-135		
8-010	AN6246-5	-010	MS28782-5	-10	8-136		-136		
8-011	AN6246-6	-011	MS28782-6	-11	8-137		-137		
8-012	AN6246-7	-012	MS28782-7	-12	8-138		-138		
8-013		-013			8-139		-139		
8-014		-014			8-140		-140		
8-015		-015			8-141		-141		
8-016		-016			8-142		-142		
8-017		-017			8-143		-143		
8-018		-018			8-144		-144		
8-019		-019			8-145		-145		
8-020		-020			8-146		-146		
8-021		-021			8-147		-147		
8-022		-022			8-148		-148		
8-023		-023			8-149		-149		
8-024		-024			8-210	AN6246-15	-210	MS28782-15	-210
8-025		-025			8-211	AN6246-16	-211	MS28782-16	-211
8-026		-026			8-212	AN6246-17	-212	MS28782-17	-212
8-027		-027			8-213	AN6246-18	-213	MS28782-18	-213
8-028		-028			8-214	AN6246-19	-214	MS28782-19	-214
8-110	AN6246-8	-110	MS28782-8	-110	8-215	AN6246-20	-215	MS28782-20	-215
8-111	AN6246-9	-111	MS28782-9	-111	8-216	AN6246-21	-216	MS28782-21	-216
8-112	AN6246-10	-112	MS28782-10	-112	8-217	AN6246-22	-217	MS28782-22	-217
8-113	AN6246-11	-113	MS28782-11	-113	8-218	AN6246-23	-218	MS28782-23	-218
8-114	AN6246-12	-114	MS28782-12	-114	8-219	AN6246-24	-219	MS28782-24	-219
8-115	AN6246-13	-115	MS28782-13	-115	8-220	AN6246-25	-220	MS28782-25	-220
8-116	AN6246-14	-116	MS28782-14	-116	8-221	AN6246-26	-221	MS28782-26	-221
8-117		-117			8-222	AN6246-27	-222	MS28782-27	-222
8-118		-118			8-223	AN6244-1	-223	MS28783-1	-223
8-119		-119			8-224	AN6244-2	-224	MS28783-2	-224
8-120		-120			8-225	AN6244-3	-225	MS28783-3	-225
8-121		-121			8-226	AN6244-4	-226	MS28783-4	-226
8-122		-122			8-227	AN6244-5	-227	MS28783-5	-227
8-123		-123			8-228	AN6244-6	-228	MS28783-6	-228
8-124		-124			8-229	AN6244-7	-229	MS28783-7	-229
8-125		-125			8-230	AN6244-8	-230	MS28783-8	-230
8-126		-126			8-231	AN6244-9	-231	MS28783-9	-231
8-127		-127			8-232	AN6244-10	-232	MS28783-10	-232
8-128		-128			8-233	AN6244-11	-233	MS28783-11	-233
8-129		-129			8-234	AN6244-12	-234	MS28783-12	-234

*Add Parker compound number N1444-90 to complete the call out. Example: N1444-90 8-009.

Note: These corresponding part numbers do not have identical dimensions, but they are intended for use with O-rings of the same dimensions. Parbak sizes with no corresponding military part number are not shown.

1. Continuous back-up ring.
2. Single turn, scarf cut.
3. Double turn.

Table 6-2: Back-Up Rings Cross Reference



WARNING: These products can expose you to chemicals including carbon black (airborne and extracts), antimony trioxide, titanium dioxide, silica (crystalline), di(2-ethylhexyl) phthalate, ethylene thiourea, acrylonitrile, 1,3-butadiene, epichlorohydrin, toluenediisocyanate, tetrafluoroethylene, ethylbenzene, formaldehyde, furfuryl alcohol, glass fibers, methyl isobutyl ketone, nickel (metallic and compounds), lead and lead compounds which are known to the State of California to cause cancer; and 1,3-butadiene, epichlorohydrin, di(2-ethylhexyl)phthalate, di-isodecyl phthalate, ethylene thiourea, methyl isobutyl ketone, methanol, toluene, lead and lead compounds which are known to the State of California to cause birth defects and other reproductive harm. For more information go to www.P65Warnings.ca.gov.

Back-Up Rings Cross Reference (Continued)

Parker N1444-90	MIL-W-5521 Leather	AS8791 PTFE	AS8791 PTFE	MIL-W-5521 Leather	Parker N1444-90	MIL-W-5521 Leather	AS8791 PTFE	AS8791 PTFE	MIL-W-5521 Leather
Parker Parbak Size No.*1	AN6244 ¹ AN6246 ¹	MS27595 ¹ MS28774 ² Dash No.	MS28782 ³ MS28783 ³	MS35803 ¹ Dash No.	Parker Parbak Size No.*1	AN6244 ¹ AN6246 ¹	MS27595 ¹ MS28774 ² Dash No.	MS28782 ³ MS28783 ³	MS35803 ¹ Dash No.
8-235	AN6244-13	-235	MS28783-13	-235	8-336	AN6246-39	-336	MS28782-39	-336
8-236	AN6244-14	-236	MS28783-14	-236	8-337	AN6246-40	-337	MS28782-40	-337
8-237	AN6244-15	-237	MS28783-15	-237	8-338	AN6246-41	-338	MS28782-41	-338
8-238	AN6244-16	-238	MS28783-16	-238	8-339	AN6246-42	-339	MS28782-42	-339
8-239	AN6244-17	-239	MS28783-17	-239	8-340	AN6246-43	-340	MS28782-43	-340
8-240	AN6244-18	-240	MS28783-18	-240	8-341	AN6246-44	-341	MS28782-44	-341
8-241	AN6244-19	-241	MS28783-19	-241	8-342	AN6246-45	-342	MS28782-45	-342
8-242	AN6244-20	-242	MS28783-20	-242	8-343	AN6246-46	-343	MS28782-46	-343
8-243	AN6244-21	-243	MS28783-21	-243	8-344	AN6246-47	-344	MS28782-47	-344
8-244	AN6244-22	-244	MS28783-22	-244	8-345	AN6246-48	-345	MS28782-48	-345
8-245	AN6244-23	-245	MS28783-23	-245	8-346	AN6246-49	-346	MS28782-49	-346
8-246	AN6244-24	-246	MS28783-24	-246	8-347	AN6246-50	-347	MS28782-50	-347
8-247	AN6244-25	-247	MS28783-25	-247	8-348	AN6246-51	-348	MS28782-51	-348
8-248	AN6244-26				8-349	AN6246-52	-349	MS28782-52	-349
8-249	AN6244-27				8-425	AN6246-88	-425	MS28782-88	-425
8-250	AN6244-28				8-426	AN6246-53	-426	MS28782-53	-426
8-251	AN6244-29				8-427	AN6246-54	-427	MS28782-54	-427
8-252	AN6244-30				8-428	AN6246-55	-428	MS28782-55	-428
8-253	AN6244-31				8-429	AN6246-56	-429	MS28782-56	-429
8-254	AN6244-32				8-430	AN6246-57	-430	MS28782-57	-430
8-255	AN6244-33				8-431	AN6246-58	-431	MS28782-58	-431
8-256	AN6244-34				8-432	AN6246-59	-432	MS28782-59	-432
8-257	AN6244-35				8-433	AN6246-60	-433	MS28782-60	-433
8-258	AN6244-36				8-434	AN6246-61	-434	MS28782-61	-434
8-259	AN6244-37				8-435	AN6246-62	-435	MS28782-62	-435
8-260	AN6244-38				8-436	AN6246-63	-436	MS28782-63	-436
8-261	AN6244-39				8-437	AN6246-64	-437	MS28782-64	-437
8-262	AN6244-40				8-438	AN6246-65	-438	MS28782-65	-438
8-263	AN6244-41				8-439	AN6246-66	-439	MS28782-66	-439
8-264	AN6244-42				8-440	AN6246-67	-440	MS28782-67	-440
8-265	AN6244-43				8-441	AN6246-68	-441	MS28782-68	-441
8-266	AN6244-44				8-442	AN6246-69	-442	MS28782-69	-442
8-267	AN6244-45				8-443	AN6246-70	-443	MS28782-70	-443
8-268	AN6244-46				8-444	AN6246-71	-444	MS28782-71	-444
8-269	AN6244-47				8-445	AN6246-72	-445	MS28782-72	-445
8-270	AN6244-48				8-446	AN6246-73	-446	MS28782-73	-446
8-271	AN6244-49				8-447	AN6246-74	-447	MS28782-74	-447
8-272	AN6244-50				8-448	AN6246-75	-448	MS28782-75	-448
8-273	AN6244-51				8-449	AN6246-76	-449	MS28782-76	-449
8-274	AN6244-52				8-450	AN6246-77	-450	MS28782-77	-450
8-325	AN6246-28	-325	MS28782-28	-325	8-451	AN6246-78	-451	MS28782-78	-451
8-326	AN6246-29	-326	MS28782-29	-326	8-452	AN6246-79	-452	MS28782-79	-452
8-327	AN6246-30	-327	MS28782-30	-327	8-453	AN6246-80	-453	MS28782-80	-453
8-328	AN6246-31	-328	MS28782-31	-328	8-454	AN6246-81	-454	MS28782-81	-454
8-329	AN6246-32	-329	MS28782-32	-329	8-455	AN6246-82	-455	MS28782-82	-455
8-330	AN6246-33	-330	MS28782-33	-330	8-456	AN6246-83	-456	MS28782-83	-456
8-331	AN6246-34	-331	MS28782-34	-331	8-457	AN6246-84	-457	MS28782-84	-457
8-332	AN6246-35	-332	MS28782-35	-332	8-458	AN6246-85	-458	MS28782-85	-458
8-333	AN6246-36	-333	MS28782-36	-333	8-459	AN6246-86	-459	MS28782-86	-459
8-334	AN6246-37	-334	MS28782-37	-334	8-460	AN6246-87	-460	MS28782-87	-460
8-335	AN6246-38	-335	MS28782-38	-335					

*Add Parker compound number N1444-90 to complete the call out. Example: N1444-90 8-009.

Note: These corresponding part numbers do not have identical dimensions, but they are intended for use with O-rings of the same dimensions. Parbak sizes with no corresponding military part number are not shown.

1. Continuous back-up ring.
2. Single turn, scarf cut.
3. Double turn.

Table 6-2: Back-Up Rings Cross Reference

WARNING: These products can expose you to chemicals including carbon black (airborne and extracts), antimony trioxide, titanium dioxide, silica (crystalline), di(2-ethylhexyl) phthalate, ethylene thiourea, acrylonitrile, 1,3-butadiene, epichlorohydrin, toluenediisocyanate, tetrafluoroethylene, ethylbenzene, formaldehyde, furfuryl alcohol, glass fibers, methyl isobutyl ketone, nickel (metallic and compounds), lead and lead compounds which are known to the State of California to cause cancer; and 1,3-butadiene, epichlorohydrin, di(2-ethylhexyl)phthalate, di-isodecyl phthalate, ethylene thiourea, methyl isobutyl ketone, methanol, toluene, lead and lead compounds which are known to the State of California to cause birth defects and other reproductive harm. For more information go to www.P65Warnings.ca.gov.

Comparison of Parbak vs. PTFE and Leather Back-Up

Parker Parbaks	PTFE Back-Up Rings	Leather Back-Up Rings
Continuous ring.	Spiral or scarf-cut for most applications. This discontinuity is often a cause of leaks or damage to the O-ring.	Continuous ring.
Easiest and quickest to assemble in either piston or cylinder groove.	Moderately simple to assemble. Scarf or spiral cut can be opened, for assembling over piston or doubled over itself for assembly into cylinder groove.	Difficult to assemble over piston. Must be soaked in oil, stretched, then pounded into place. Less difficult to assemble into cylinder groove.
Good resistance to extrusion. Standard material satisfactory up to (121°C) 250°F. Other compounds available for temperatures as high as (204°C) 400°F.	Tends to soften and extrude at temperatures around (149°C) 300°F.	Tends to harden and crack at high temperature.
Does not cause overly smooth rubbing surface. Maintains lubrication.	Deposits on rubbing surface making it extremely smooth. The O-ring then wipes the surface dry.	Does not cause overly smooth rubbing surface. Maintains lubrication.
Good resistance to radiation. Can be made in compound having even better resistance when required.	Fair resistance to radiation.	No information available.
Continuous ring with no loose particles or sections.	Thin sections of spiral may become lodged under O-ring causing leakage.	Loose leather fibers may become lodged under O-ring causing leakage.
No scarf cut to open. Coefficient of thermal expansion comparable to O-ring material.	Low temperature shrinkage may open up scarf cut, causing temperature leakage.	Continuous ring.
Continuous ring, no scarf cut.	High temperature expansion may overlap scarf cut causing damage to O-ring.	Continuous ring, no scarf cut.
Absorbs slight amount of oil, aiding lubrication.	Almost completely non-absorbent, will not hold enough oil to aid lubrication.	Tends to absorb moisture, increasing possibility of corrosion.
Resists cold flow and tendency to extrude under high pressure.	Will cold flow and extrude at room temperature and high pressure.	Resists cold flow and tendency to extrude under high pressure.
Uniform dimensions.	Uniform dimensions.	Variable dimensions.

Table 6-3: Comparison of Parbak vs. PTFE and Leather Back-Up

WARNING: These products can expose you to chemicals including carbon black (airborne and extracts), antimony trioxide, titanium dioxide, silica (crystalline), di(2-ethylhexyl) phthalate, ethylene thiourea, acrylonitrile, 1,3-butadiene, epichlorohydrin, toluenediisocyanate, tetrafluoroethylene, ethylbenzene, formaldehyde, furfuryl alcohol, glass fibers, methyl isobutyl ketone, nickel (metallic and compounds), lead and lead compounds which are known to the State of California to cause cancer; and 1,3-butadiene, epichlorohydrin, di(2-ethylhexyl)phthalate, di-isodecyl phthalate, ethylene thiourea, methyl isobutyl ketone, methanol, toluene, lead and lead compounds which are known to the State of California to cause birth defects and other reproductive harm. For more information go to www.P65Warnings.ca.gov.

Section VII – Compatibility Tables for Gases, Fluids, Solids

Fluid Compatibility Table 7-2

 **WARNING:** These products can expose you to chemicals including carbon black (airborne and extracts), antimony trioxide, titanium dioxide, silica (crystalline), di(2-ethylhexyl) phthalate, ethylene thiourea, acrylonitrile, 1,3-butadiene, epichlorohydrin, toluenediisocyanate, tetrafluoroethylene, ethylbenzene, formaldehyde, furfuryl alcohol, glass fibers, methyl isobutyl ketone, nickel (metallic and compounds), lead and lead compounds which are known to the State of California to cause cancer; and 1,3-butadiene, epichlorohydrin, di(2-ethylhexyl)phthalate, di-isodecyl phthalate, ethylene thiourea, methyl isobutyl ketone, methanol, toluene, lead and lead compounds which are known to the State of California to cause birth defects and other reproductive harm. For more information go to www.P65Warnings.ca.gov.

Compatibility Tables for Gases, Fluids, Solids

COMPOUND COMPATIBILITY RATING
 1 - Satisfactory
 2 - Fair (usually OK for static seal)
 3 - Doubtful (sometimes OK for static seal)
 4 - Unsatisfactory
 x - Insufficient Data

Compound	Recommended	Nitrile NBR	Hydrogenated Nitrile HNBR	Ethylene Propylene EPDM	Fluorocarbon FKM	Hifluor FKM	Perfluoroelastomer FFKM	Aflas (TFE/Propylene) FEPDM	Neoprene/Chloroprene CR	Styrene-Butadiene SBR	Polyacrylate ACM	Polyurethane AU, EU	Butyl IIR	Butadiene BR	Isoprene IR	Natural Rubber NR	Hypalon CSM	Fluorosilicone FVMQ	Silicone MQ, VMQ, PVMQ
- A -																			
A-A-52624	E1267-80	X	X	X	X	X	X	X	X	X	X	X	X	X	X	X	X	X	X
A-A-59290	E1267-80	X	X	X	X	X	X	X	X	X	X	X	X	X	X	X	X	X	X
Abietic Acid	V3819-75	X	X	X	X	1	1	X	X	X	X	X	X	X	X	X	X	X	X
Acetaldehyde	E0540-80	3	3	2	4	1	1	3	3	3	4	4	2	2	2	2	3	4	2
Acetamide	C0873-70	1	1	1	3	1	1	2	1	4	4	4	2	4	4	4	2	1	2
Acetanilide	E0540-80	3	3	1	3	1	1	X	1	1	4	4	1	1	1	1	1	1	2
Acetic Acid, 30%	E0540-80	X	X	1	X	1	1	X	X	X	X	X	X	X	X	X	X	X	X
Acetic Acid, 5%	E0540-80	2	2	1	1	1	1	1	1	2	4	4	1	2	2	2	1	2	1
Acetic Acid, Glacial	E0540-80	2	2	1	2	1	1	3	4	2	4	4	2	2	2	2	3	2	1
Acetic Acid, Hot, High Pressure	FF200-75	4	4	3	4	2	1	3	4	4	4	4	4	4	4	4	3	4	3
Acetic Anhydride	C0873-70	3	4	2	4	1	1	2	2	2	4	4	2	2	2	2	2	4	2
Acetoacetic Acid	E0540-80	3	3	1	3	1	1	X	1	1	4	4	1	1	1	1	1	1	2
Acetone	E0540-80	4	4	1	4	2	1	2	4	4	4	4	1	4	4	4	3	4	4
Acetone Cyanohydrin	E0540-80	3	3	1	3	1	1	X	1	1	4	4	1	1	1	1	1	1	2
Acetonitrile (Methyl Cyanide)	E0540-80	3	3	1	3	1	1	1	X	X	X	X	X	X	X	X	X	X	X
Acetophenetidine	V1164-75	2	2	4	1	1	1	X	4	4	4	3	4	4	4	4	4	2	X
Acetophenone	E0540-80	4	4	1	4	2	1	2	4	4	4	4	2	4	4	4	4	4	4
Acetotoluidide	V1164-75	2	2	4	1	1	1	X	4	4	4	3	4	4	4	4	4	2	X
Acetyl Acetone	E0540-80	4	4	1	4	2	1	2	4	4	4	4	1	4	4	4	4	4	4
Acetyl Bromide	V1164-75	4	4	1	1	1	1	2	4	4	4	4	1	4	4	4	4	4	4
Acetyl Chloride	V1164-75	4	4	4	1	1	1	2	4	4	4	4	4	4	4	4	4	1	4
Acetylene	E0540-80	1	1	1	1	1	1	1	2	2	4	4	1	2	2	2	2	X	2
Acetylene Tetrabromide	V1164-75	4	4	1	1	1	1	1	2	4	X	4	1	X	X	X	X	X	X
Acetylene Tetrachloride	V1164-75	4	4	1	1	1	1	1	2	4	X	4	1	X	X	X	X	X	X
Acetylsalicylic Acid	V1164-75	2	2	4	1	1	1	X	4	4	4	3	4	4	4	4	4	2	X
Acids, Non-organic	V3819-75	X	X	X	X	1	1	X	X	X	X	X	X	X	X	X	X	X	X
Acids, Organic	V3819-75	X	X	X	X	1	1	X	X	X	X	X	X	X	X	X	X	X	X
Aconitic Acid	V3819-75	X	X	X	X	1	1	X	X	X	X	X	X	X	X	X	X	X	X
Acridine	V3819-75	X	X	X	X	1	1	X	X	X	X	X	X	X	X	X	X	X	X
Acrolein	E0540-80	3	3	1	3	1	1	X	1	1	4	4	1	1	1	1	1	1	2
Acrylic Acid	V1164-75	2	2	4	1	1	1	X	4	4	4	3	4	4	4	4	4	2	X
Acrylonitrile	FF500-75	4	4	4	3	1	1	3	4	3	4	4	4	X	3	3	3	4	4
Adipic Acid	E0540-80	1	1	2	X	1	1	2	X	X	X	X	X	X	X	X	X	X	X
Aero Lubriplate	N0674-70	1	1	4	1	1	1	2	1	2	1	1	4	4	4	4	1	1	2
Aero Shell 17 Grease	N0674-70	1	1	4	1	1	1	2	2	4	1	1	4	4	4	4	1	1	2

Approximate Service Temperature Ranges for Commonly Used Basic Polymer Types*

Nitrile (General Service)	-34°C to 121°C (-30°F to 250°F)*	AFLAS	-9°C to 232°C (15°F to 450°F)*
Nitrile (Low Temperature)	-55°C to 107°C (-65°F to 225°F)*	Neoprene	-51°C to 107°C (-60°F to 225°F)*
Hydrogenated Nitrile	-32°C to 149°C (-23°F to 300°F)*	Polyacrylate	-21°C to 177°C (-5°F to 350°F)*
Ethylene Propylene	-57°C to 121°C (-70°F to 250°F)*	Polyurethane	-40°C to 82°C (-40°F to 180°F)*
Fluorocarbon	-26°C to 205°C (-15°F to 400°F)*	Butyl	-59°C to 120°C (-75°F to 250°F)*
Hifluor	-26°C to 205°C (-15°F to 400°F)*	Fluorosilicone	-73°C to 177°C (-100°F to 350°F)*
Perfluoroelastomer (Parofluor)	-26°C to 320°C (-15°F to 608°F)*	Silicone	-115°C to 232°C (-175°F to 450°F)*

NOTE: *These temperature ranges will apply to the majority of media for which the material is potentially recommended. With some media however, the service temperature range may be significantly different. ALWAYS TEST UNDER ACTUAL SERVICE CONDITIONS.

WARNING: These products can expose you to chemicals including carbon black (airborne and extracts), antimony trioxide, titanium dioxide, silica (crystalline), di(2-ethylhexyl) phthalate, ethylene thiourea, acrylonitrile, 1,3-butadiene, epichlorohydrin, toluenediisocyanate, tetrafluoroethylene, ethylbenzene, formaldehyde, furfuryl alcohol, glass fibers, methyl isobutyl ketone, nickel (metallic and compounds), lead and lead compounds which are known to the State of California to cause cancer; and 1,3-butadiene, epichlorohydrin, di(2-ethylhexyl)phthalate, di-isodecyl phthalate, ethylene thiourea, methyl isobutyl ketone, methanol, toluene, lead and lead compounds which are known to the State of California to cause birth defects and other reproductive harm. For more information go to www.P65Warnings.ca.gov.

COMPOUND COMPATIBILITY RATING
 1 - Satisfactory
 2 - Fair (usually OK for static seal)
 3 - Doubtful (sometimes OK for static seal)
 4 - Unsatisfactory
 x - Insufficient Data

	Recommended	Nitrile NBR	Hydrogenated Nitrile HNBR	Ethylene Propylene EPDM	Fluorocarbon FKM	Hifluor FKM	Perfluoroelastomer FFKM	Aflas (TFE/Propylene) FEPDM	Neoprene/Chloroprene CR	Styrene-Butadiene SBR	Polyacrylate ACM	Polyurethane AU, EU	Butyl IIR	Butadiene BR	Isoprene IR	Natural Rubber NR	Hypalon CSM	Fluorosilicone FVMQ	Silicone MQ, VMQ, PVMQ
Aero Shell 560	VM835-75	X	X	X	X	X	X	X	X	X	X	X	X	X	X	X	X	X	X
Aero Shell 750	V1164-75	2	2	4	1	1	1	2	4	4	2	4	4	4	4	4	4	2	4
Aero Shell 7A Grease (MIL-G-23827)	N0674-70	2	2	4	1	1	1	2	2	4	1	1	4	4	4	4	1	1	2
Aero Shell IAC	N0674-70	1	1	4	1	1	1	2	2	4	1	1	4	4	4	4	1	1	2
Aerosafe 2300	E0540-80	4	4	1	4	1	1	2	4	4	4	4	2	4	4	4	4	3	3
Aerosafe 2300W	E0540-80	4	4	1	4	1	1	2	4	4	4	4	2	4	4	4	4	3	3
Aerozene 50 (50% Hydrazine 50% UDMH)	E0540-80	3	3	1	4	3	2	2	4	4	X	4	1	4	4	4	4	4	4
Air, Below 200° F	E0540-80	2	2	1	1	1	1	1	1	2	1	2	1	2	2	2	1	1	1
Air, 200 - 300° F	S0604-70	3	3	2	1	1	1	1	2	4	2	3	2	4	4	4	2	1	1
Air, 300 - 400° F	S0604-70	4	4	4	1	1	1	2	4	4	4	4	4	4	4	4	4	2	1
Air, 400 - 500° F	S0455-70	4	4	4	3	2	2	3	4	4	4	4	4	4	4	4	4	4	2
Aliphatic Dicarboxylic Acid	V1164-75	2	2	4	1	1	1	X	4	4	4	3	4	4	4	4	4	2	X
Alkanes (Paraffin Hydrocarbons)	N0674-70	1	1	4	1	1	1	X	2	4	1	1	4	4	4	4	2	1	2
Alkanesulfonic Acid	N0674-70	1	1	4	1	1	1	X	2	4	1	1	4	4	4	4	2	1	2
Alkazene	V1164-75	4	4	4	2	1	1	2	4	4	4	4	4	4	4	4	4	2	4
Alkenes (Olefin Hydrocarbons)	V1164-75	2	2	4	1	1	1	X	4	4	4	3	4	4	4	4	4	2	X
Alkyl Acetone	E0540-80	3	3	1	3	2	1	X	1	1	4	4	1	1	1	1	1	1	2
Alkyl Alcohol	N0674-70	1	1	4	1	1	1	X	2	4	1	1	4	4	4	4	2	1	2
Alkyl Amine	N0674-70	1	1	4	1	1	1	X	2	4	1	1	4	4	4	4	2	1	2
Alkyl Aryl Sulfonates	N0674-70	1	1	4	1	1	1	X	2	4	1	1	4	4	4	4	2	1	2
Alkyl Aryl Sulfonics	N0674-70	1	1	4	1	1	1	X	2	4	1	1	4	4	4	4	2	1	2
Alkyl Benzene	V1164-75	2	2	4	1	1	1	X	4	4	4	3	4	4	4	4	4	2	X
Alkyl Chloride	V1164-75	2	2	4	1	1	1	X	4	4	4	3	4	4	4	4	4	2	X
Alkyl Lithium	FF500-75	X	X	X	X	X	X	X	X	X	X	X	X	X	X	X	X	X	X
Alkyl Sulfide*	V1164-75	2	2	4	1	1	1	X	4	4	4	3	4	4	4	4	4	2	X
Alkyl naphthalene Sulfonic Acid	N0674-70	1	1	4	1	1	1	X	2	4	1	1	4	4	4	4	2	1	2
Allyl Chloride	V1164-75	2	2	4	1	1	1	X	1	X	X	X	X	X	X	X	X	X	X
Allylidene Diacetate	E0540-80	3	3	1	3	2	1	X	1	1	4	4	1	1	1	1	1	1	2
Alpha Picoline	E0540-80	3	3	1	3	1	1	X	1	1	4	4	1	1	1	1	1	1	2
Aluminum Acetate	E0540-80	2	2	1	4	1	1	2	2	2	4	4	1	4	1	1	4	4	4
Aluminum Bromide	N0674-70	1	1	1	1	1	1	1	1	1	1	3	1	1	1	1	1	1	1
Aluminum Chlorate	E0540-80	3	3	1	3	1	1	X	1	1	4	4	1	1	1	1	1	1	2
Aluminum Chloride	N0674-70	1	1	1	1	1	1	1	1	1	1	3	1	1	1	1	1	1	2
Aluminum Ethylate	V3819-75	X	X	X	X	1	1	X	X	X	X	X	X	X	X	X	X	X	X
Aluminum Fluoride	N0674-70	1	1	1	1	1	1	1	1	1	X	3	1	1	1	2	1	1	2
Aluminum Fluorosilicate*	V3819-75	X	X	X	X	1	1	X	X	X	X	X	X	X	X	X	X	X	X
Aluminum Formate	E0540-80	3	3	1	3	1	1	X	1	1	4	4	1	1	1	1	1	1	2
Aluminum Hydroxide	E0540-80	2	X	1	2	1	1	1	X	X	X	X	X	X	X	X	X	X	2
Aluminum Linoleate	N0674-70	1	1	4	1	1	1	X	2	4	1	1	4	4	4	4	2	1	2
Aluminum Nitrate	N0674-70	1	1	1	1	1	1	1	1	1	X	3	1	1	1	1	1	X	2

Approximate Service Temperature Ranges for Commonly Used Basic Polymer Types*

Nitrile (General Service)	-34°C to 121°C (-30°F to 250°F)*	AFLAS	-9°C to 232°C (15°F to 450°F)*
Nitrile (Low Temperature)	-55°C to 107°C (-65°F to 225°F)*	Neoprene	-51°C to 107°C (-60°F to 225°F)*
Hydrogenated Nitrile	-32°C to 149°C (-23°F to 300°F)*	Polyacrylate	-21°C to 177°C (-5°F to 350°F)*
Ethylene Propylene	-57°C to 121°C (-70°F to 250°F)*	Polyurethane	-40°C to 82°C (-40°F to 180°F)*
Fluorocarbon	-26°C to 205°C (-15°F to 400°F)*	Butyl	-59°C to 120°C (-75°F to 250°F)*
Hifluor	-26°C to 205°C (-15°F to 400°F)*	Fluorosilicone	-73°C to 177°C (-100°F to 350°F)*
Perfluoroelastomer (Parofluor)	-26°C to 320°C (-15°F to 608°F)*	Silicone	-115°C to 232°C (-175°F to 450°F)*

NOTE: *These temperature ranges will apply to the majority of media for which the material is potentially recommended. With some media however, the service temperature range may be significantly different. ALWAYS TEST UNDER ACTUAL SERVICE CONDITIONS.

WARNING: These products can expose you to chemicals including carbon black (airborne and extracts), antimony trioxide, titanium dioxide, silica (crystalline), di(2-ethylhexyl) phthalate, ethylene thiourea, acrylonitrile, 1,3-butadiene, epichlorohydrin, toluenediisocyanate, tetrafluoroethylene, ethylbenzene, formaldehyde, furfuryl alcohol, glass fibers, methyl isobutyl ketone, nickel (metallic and compounds), lead and lead compounds which are known to the State of California to cause cancer; and 1,3-butadiene, epichlorohydrin, di(2-ethylhexyl)phthalate, di-isodecyl phthalate, ethylene thiourea, methyl isobutyl ketone, methanol, toluene, lead and lead compounds which are known to the State of California to cause birth defects and other reproductive harm. For more information go to www.P65Warnings.ca.gov.

Compatibility Tables for Gases, Fluids, Solids

COMPOUND COMPATIBILITY RATING
 1 - Satisfactory
 2 - Fair (usually OK for static seal)
 3 - Doubtful (sometimes OK for static seal)
 4 - Unsatisfactory
 x - Insufficient Data

	Recommended	Nitrile NBR	Hydrogenated Nitrile HNBR	Ethylene Propylene EPDM	Fluorocarbon FKM	Hifluor FKM	Perfluoroelastomer FFKM	Aflas (TFE/Propylene) FFKM	Neoprene/Chloroprene CR	Styrene-Butadiene SBR	Polyacrylate ACM	Polyurethane AU, EU	Butyl IIR	Butadiene BR	Isoprene IR	Natural Rubber NR	Hypalon CSM	Fluorosilicone FVMQ	Silicone MQ, VMQ, PVMQ
Aluminum Oxalate	E0540-80	3	3	1	3	1	1	X	1	1	4	4	1	1	1	1	1	1	2
Aluminum Phosphate	E0540-80	1	1	1	1	1	1	1	1	X	X	X	X	X	X	X	X	X	2
Aluminum Potassium Sulfate	E0540-80	3	3	1	3	1	1	X	1	1	4	4	1	1	1	1	1	1	2
Aluminum Salts	N0674-70	1	1	1	1	1	1	1	1	1	3	1	1	1	1	1	1	1	1
Aluminum Sodium Sulfate	E0540-80	3	3	1	3	1	1	X	1	1	4	4	1	1	1	1	1	1	2
Aluminum Sulfate	N0674-70	1	1	1	1	1	1	1	2	4	4	1	1	1	1	1	1	1	1
Alums-NH3 -Cr -K	N0674-70	1	1	1	4	1	1	2	1	1	4	X	1	1	1	1	1	4	1
Ambrex 33 (Mobil)	N0674-70	1	1	4	1	1	1	2	2	4	1	2	4	4	4	4	3	3	4
Ambrex 830 (Mobil)	N0674-70	1	1	3	1	1	1	2	2	4	1	1	3	4	4	4	2	1	2
Amines-Mixed	C0873-70	4	4	2	4	3	2	3	2	2	4	4	2	2	2	2	4	4	2
Aminoanthraquinone	V3819-75	X	X	X	X	1	1	X	X	X	X	X	X	X	X	X	X	X	X
Aminoazobenzene	V3819-75	X	X	X	X	1	1	X	X	X	X	X	X	X	X	X	X	X	X
Aminobenzene Sulfonic Acid	V3819-75	X	X	X	X	1	1	X	X	X	X	X	X	X	X	X	X	X	X
Aminobenzoic Acid	V3819-75	X	X	X	X	1	1	X	X	X	X	X	X	X	X	X	X	X	X
Aminopyridine	V3819-75	X	X	X	X	1	1	X	X	X	X	X	X	X	X	X	X	X	X
Aminosalicylic Acid	V3819-75	X	X	X	X	1	1	X	X	X	X	X	X	X	X	X	X	X	X
Ammonia (Anhydrous)	C0873-70	2	2	1	4	3	2	2	1	4	4	4	1	4	4	4	4	4	2
Ammonia and Lithium Metal in Solution	E0540-80	2	2	2	4	4	4	3	X	4	4	4	2	4	4	4	4	4	4
Ammonia, Gas, Cold	C0873-70	1	1	1	4	2	1	2	1	1	4	X	1	1	1	1	1	4	1
Ammonia, Gas, Hot	C0873-70	4	4	2	4	3	2	2	2	4	4	X	2	4	4	4	2	4	X
Ammonia, Liquid (Anhydrous)	C0873-70	2	2	1	4	3	2	2	1	4	4	4	1	4	4	4	2	4	2
Ammonium Acetate	E0540-80	3	3	1	3	2	1	X	1	1	4	4	1	1	1	1	1	1	2
Ammonium Arsenate	E0540-80	3	3	1	3	1	1	X	1	1	4	4	1	1	1	1	1	1	2
Ammonium Benzoate	E0540-80	3	3	1	3	1	1	X	1	1	4	4	1	1	1	1	1	1	2
Ammonium Bicarbonate	E0540-80	3	3	1	3	1	1	X	1	1	4	4	1	1	1	1	1	1	2
Ammonium Bisulfite	E0540-80	3	3	1	3	1	1	X	1	1	4	4	1	1	1	1	1	1	2
Ammonium Bromide	N0674-70	1	1	1	1	1	1	1	1	1	X	1	1	X	X	1	1	X	X
Ammonium Carbamate	E0540-80	3	3	1	3	1	1	X	1	1	4	4	1	1	1	1	1	1	2
Ammonium Carbonate	C0873-70	4	4	1	1	1	1	1	1	1	4	4	1	X	X	1	1	X	X
Ammonium Chloride, 2N	N0674-70	1	1	1	1	1	1	1	1	1	X	1	1	X	X	1	1	X	X
Ammonium Citrate	E0540-80	3	3	1	3	1	1	X	1	1	4	4	1	1	1	1	1	1	2
Ammonium Dichromate	E0540-80	3	3	1	3	1	1	X	1	1	4	4	1	1	1	1	1	1	2
Ammonium Diphosphate	E0540-80	3	3	1	3	1	1	X	1	1	4	4	1	1	1	1	1	1	2
Ammonium Fluoride	N0674-70	1	1	1	1	1	1	1	1	1	X	1	1	X	X	1	1	X	X
Ammonium Fluorosilicate*	V3819-75	X	X	X	X	1	1	X	X	X	X	X	X	X	X	X	X	X	X
Ammonium Formate	E0540-80	3	3	1	3	1	1	X	1	1	4	4	1	1	1	1	1	1	2
Ammonium Hydroxide, 3 Molar	E0540-80	1	1	1	3	2	2	2	1	2	4	4	1	2	2	2	1	1	1
Ammonium Hydroxide, Concentrated	E0540-80	4	4	1	4	3	2	2	1	3	4	4	1	3	3	3	1	1	1
Ammonium Iodide	N0674-70	1	1	1	1	1	1	1	1	1	X	1	1	X	X	1	1	X	X
Ammonium Lactate	E0540-80	3	3	1	3	1	1	X	1	1	4	4	1	1	1	1	1	1	2

Approximate Service Temperature Ranges for Commonly Used Basic Polymer Types*

Nitrile (General Service)	-34°C to 121°C (-30°F to 250°F)*	AFLAS	-9°C to 232°C (15°F to 450°F)*
Nitrile (Low Temperature)	-55°C to 107°C (-65°F to 225°F)*	Neoprene	-51°C to 107°C (-60°F to 225°F)*
Hydrogenated Nitrile	-32°C to 149°C (-23°F to 300°F)*	Polyacrylate	-21°C to 177°C (-5°F to 350°F)*
Ethylene Propylene	-57°C to 121°C (-70°F to 250°F)*	Polyurethane	-40°C to 82°C (-40°F to 180°F)*
Fluorocarbon	-26°C to 205°C (-15°F to 400°F)*	Butyl	-59°C to 120°C (-75°F to 250°F)*
Hifluor	-26°C to 205°C (-15°F to 400°F)*	Fluorosilicone	-73°C to 177°C (-100°F to 350°F)*
Perfluoroelastomer (Parofluor)	-26°C to 320°C (-15°F to 608°F)*	Silicone	-115°C to 232°C (-175°F to 450°F)*

NOTE: *These temperature ranges will apply to the majority of media for which the material is potentially recommended. With some media however, the service temperature range may be significantly different. ALWAYS TEST UNDER ACTUAL SERVICE CONDITIONS.

WARNING: These products can expose you to chemicals including carbon black (airborne and extracts), antimony trioxide, titanium dioxide, silica (crystalline), di(2-ethylhexyl) phthalate, ethylene thiourea, acrylonitrile, 1,3-butadiene, epichlorohydrin, toluenediisocyanate, tetrafluoroethylene, ethylbenzene, formaldehyde, furfuryl alcohol, glass fibers, methyl isobutyl ketone, nickel (metallic and compounds), lead and lead compounds which are known to the State of California to cause cancer; and 1,3-butadiene, epichlorohydrin, di(2-ethylhexyl)phthalate, di-isodecyl phthalate, ethylene thiourea, methyl isobutyl ketone, methanol, toluene, lead and lead compounds which are known to the State of California to cause birth defects and other reproductive harm. For more information go to www.P65Warnings.ca.gov.

COMPOUND COMPATIBILITY RATING
 1 - Satisfactory
 2 - Fair (usually OK for static seal)
 3 - Doubtful (sometimes OK for static seal)
 4 - Unsatisfactory
 x - Insufficient Data

	Recommended	Nitrile NBR	Hydrogenated Nitrile HNBR	Ethylene Propylene EPDM	Fluorocarbon FKM	Hifluor FKM	Perfluoroelastomer FFKM	Aflas (TFE/Propylene) FFKM	Neoprene/Chloroprene CR	Styrene-Butadiene SBR	Polyacrylate ACM	Polyurethane AU, EU	Butyl IIR	Butadiene BR	Isoprene IR	Natural Rubber NR	Hypalon CSM	Fluorosilicone FVMQ	Silicone MQ, VMQ, PVMQ
Ammonium Metaphosphate	E0540-80	3	3	1	3	1	1	X	1	1	4	4	1	1	1	1	1	1	2
Ammonium Molybdenate*	E0540-80	3	3	1	3	1	1	X	1	1	4	4	1	1	1	1	1	1	2
Ammonium Nitrate, 2N	N0674-70	1	1	1	X	X	X	2	1	1	2	X	1	X	X	3	1	X	X
Ammonium Nitrite	N0674-70	1	1	1	X	1	1	2	1	1	X	X	1	1	1	1	1	X	2
Ammonium Oxalate	E0540-80	3	3	1	3	1	1	X	1	1	4	4	1	1	1	1	1	1	2
Ammonium Perchlorate	E0540-80	3	3	1	3	1	1	X	1	1	4	4	1	1	1	1	1	1	2
Ammonium Perchloride	V3819-75	X	X	X	X	1	1	X	X	X	X	X	X	X	X	X	X	X	X
Ammonium Persulfate 10%	E0540-80	4	4	1	X	X	X	2	1	4	4	4	1	X	1	1	X	X	X
Ammonium Persulfate Solution	E0540-80	4	4	1	X	1	1	2	X	4	4	4	1	X	1	1	X	X	X
Ammonium Phosphate	N0674-70	1	1	1	4	1	1	2	1	1	X	X	1	X	1	1	1	X	1
Ammonium Phosphate, Dibasic	N0674-70	1	1	1	X	1	1	2	1	1	X	X	1	X	1	1	1	X	1
Ammonium Phosphate, Mono-Basic	N0674-70	1	1	1	X	1	1	2	1	1	X	X	1	X	1	1	1	X	1
Ammonium Phosphate, Tribasic	N0674-70	1	1	1	X	1	1	2	1	1	X	X	1	X	1	1	1	X	1
Ammonium Phosphite	E0540-80	3	3	1	3	1	1	X	1	1	4	4	1	1	1	1	1	1	2
Ammonium Picrate	E0540-80	3	3	1	3	1	1	X	1	1	4	4	1	1	1	1	1	1	2
Ammonium Polysulfide	E0540-80	3	3	1	3	1	1	X	1	1	4	4	1	1	1	1	1	1	2
Ammonium Salicylate	E0540-80	3	3	1	3	1	1	X	1	1	4	4	1	1	1	1	1	1	2
Ammonium Salts	N0674-70	1	1	1	3	1	1	2	1	1	3	X	1	X	1	1	1	3	1
Ammonium Sulfamate	E0540-80	3	3	1	3	1	1	X	1	1	4	4	1	1	1	1	1	1	2
Ammonium Sulfate	N0674-70	1	1	1	4	1	1	2	1	2	4	X	1	1	1	1	1	X	X
Ammonium Sulfate Nitrate	N0674-70	1	1	1	4	1	1	2	1	2	4	X	1	1	1	1	1	X	X
Ammonium Sulfide	N0674-70	1	1	1	4	1	1	2	1	2	4	X	1	1	1	1	1	X	X
Ammonium Sulfite	E0540-80	3	3	1	3	1	1	X	1	1	4	4	1	1	1	1	1	1	2
Ammonium Thiocyanate	E0540-80	3	3	1	3	1	1	X	1	1	4	4	1	1	1	1	1	1	2
Ammonium Thioglycolate	E0540-80	3	3	1	3	1	1	X	1	1	4	4	1	1	1	1	1	1	2
Ammonium Thiosulfate	E0540-80	3	3	1	3	1	1	X	1	1	4	4	1	1	1	1	1	1	2
Ammonium Tungstate	E0540-80	3	3	1	3	1	1	X	1	1	4	4	1	1	1	1	1	1	2
Ammonium Valerate	E0540-80	3	3	1	3	1	1	X	1	1	4	4	1	1	1	1	1	1	2
Amyl Acetate	N0674-70	1	1	3	4	1	1	3	4	4	4	4	3	4	4	4	4	4	4
Amyl Alcohol	E0540-80	2	2	1	2	1	1	1	2	2	4	4	1	2	2	2	2	1	4
Amyl Borate	N0674-70	1	1	4	1	1	1	2	1	4	X	X	4	4	4	4	1	X	X
Amyl Butyrate	N0674-70	1	1	4	1	1	1	X	2	4	1	1	4	4	4	4	2	1	2
Amyl Chloride	V1164-75	X	X	4	1	1	1	2	4	4	4	X	4	4	4	4	4	2	4
Amyl Chloronaphthalene	V1164-75	4	4	4	1	1	1	2	4	4	4	X	4	4	4	4	4	2	4
Amyl Cinnamic Aldehyde	V1164-75	2	2	4	1	1	1	X	4	4	4	3	4	4	4	4	4	2	X
Amyl Laurate	V1164-75	2	2	4	1	1	1	X	4	4	4	3	4	4	4	4	4	2	X
Amyl Mercaptan	V1164-75	2	2	4	1	1	1	X	4	4	4	3	4	4	4	4	4	2	X
Amyl Naphthalene	V1164-75	4	4	4	1	1	1	2	4	4	2	4	4	4	4	4	4	1	4
Amyl Nitrate	E0540-80	3	3	1	3	1	1	X	1	1	4	4	1	1	1	1	1	1	2
Amyl Nitrite	E0540-80	3	3	1	3	1	1	X	1	1	4	4	1	1	1	1	1	1	2

Approximate Service Temperature Ranges for Commonly Used Basic Polymer Types*

Nitrile (General Service)	-34°C to 121°C (-30°F to 250°F)*	AFLAS	-9°C to 232°C (15°F to 450°F)*
Nitrile (Low Temperature)	-55°C to 107°C (-65°F to 225°F)*	Neoprene	-51°C to 107°C (-60°F to 225°F)*
Hydrogenated Nitrile	-32°C to 149°C (-23°F to 300°F)*	Polyacrylate	-21°C to 177°C (-5°F to 350°F)*
Ethylene Propylene	-57°C to 121°C (-70°F to 250°F)*	Polyurethane	-40°C to 82°C (-40°F to 180°F)*
Fluorocarbon	-26°C to 205°C (-15°F to 400°F)*	Butyl	-59°C to 120°C (-75°F to 250°F)*
Hifluor	-26°C to 205°C (-15°F to 400°F)*	Fluorosilicone	-73°C to 177°C (-100°F to 350°F)*
Perfluoroelastomer (Parofluor)	-26°C to 320°C (-15°F to 608°F)*	Silicone	-115°C to 232°C (-175°F to 450°F)*

NOTE: *These temperature ranges will apply to the majority of media for which the material is potentially recommended. With some media however, the service temperature range may be significantly different. ALWAYS TEST UNDER ACTUAL SERVICE CONDITIONS.

WARNING: These products can expose you to chemicals including carbon black (airborne and extracts), antimony trioxide, titanium dioxide, silica (crystalline), di(2-ethylhexyl) phthalate, ethylene thiourea, acrylonitrile, 1,3-butadiene, epichlorohydrin, toluenediisocyanate, tetrafluoroethylene, ethylbenzene, formaldehyde, furfuryl alcohol, glass fibers, methyl isobutyl ketone, nickel (metallic and compounds), lead and lead compounds which are known to the State of California to cause cancer; and 1,3-butadiene, epichlorohydrin, di(2-ethylhexyl)phthalate, di-isodecyl phthalate, ethylene thiourea, methyl isobutyl ketone, methanol, toluene, lead and lead compounds which are known to the State of California to cause birth defects and other reproductive harm. For more information go to www.P65Warnings.ca.gov.

Compatibility Tables for Gases, Fluids, Solids

COMPOUND COMPATIBILITY RATING
 1 - Satisfactory
 2 - Fair (usually OK for static seal)
 3 - Doubtful (sometimes OK for static seal)
 4 - Unsatisfactory
 x - Insufficient Data

	Recommended	Nitrile NBR	Hydrogenated Nitrile HNBR	Ethylene Propylene EPDM	Fluorocarbon FKM	Hifluor FKM	Perfluoroelastomer FFKM	Aflas (TFE/Propylene) FEPDM	Neoprene/Chloroprene CR	Styrene-Butadiene SBR	Polyacrylate ACM	Polyurethane AU, EU	Butyl IIR	Butadiene BR	Isoprene IR	Natural Rubber NR	Hypalon CSM	Fluorosilicone FVMQ	Silicone MQ, VMQ, PVMQ
Amyl Phenol	V3819-75	X	X	X	X	1	1	X	X	X	X	X	X	X	X	X	X	X	X
Amyl Propionate	N0674-70	1	1	4	1	2	1	X	2	4	1	1	4	4	4	4	2	1	2
Anderol, L- 826 (di-ester)	V1164-75	2	2	4	1	1	1	2	4	4	2	4	4	4	4	4	4	2	4
Anderol, L- 829 (di-ester)	V1164-75	2	2	4	1	1	1	2	4	4	2	4	4	4	4	4	4	2	4
Anderol, L-774 (di-ester)	V1164-75	2	2	4	1	1	1	2	4	4	2	4	4	4	4	4	4	2	4
ANG-25 (Di-ester Base) (TG749)	V1164-75	2	2	4	1	1	1	2	4	4	2	4	4	4	4	4	4	2	2
ANG-25 (Glycerol Ester)	E0540-80	2	2	1	1	1	1	2	2	4	4	2	2	2	2	2	2	2	2
Aniline	E0540-80	4	4	2	3	1	1	2	4	4	4	4	2	4	4	4	4	3	4
Aniline Dyes	E0540-80	4	4	2	2	1	1	2	2	2	4	4	2	2	2	2	2	2	3
Aniline Hydrochloride	E0540-80	2	2	2	2	1	1	2	4	3	4	4	2	4	2	2	4	2	3
Aniline Oil	E0540-80	4	4	2	3	2	2	2	4	4	4	4	2	4	4	4	4	3	4
Aniline Sulfate	E0540-80	3	3	1	3	1	1	X	1	1	4	4	1	1	1	1	1	1	2
Aniline Sulfite	E0540-80	3	3	1	3	1	1	X	1	1	4	4	1	1	1	1	1	1	2
Animal Fats	N0674-70	1	1	2	1	1	1	1	2	X	X	X	X	X	X	X	X	X	X
Animal Oil (Lard Oil)	N0674-70	1	1	2	1	1	1	2	2	4	1	2	2	4	4	4	2	1	2
Anisole	V3819-75	X	X	X	X	1	1	X	X	X	X	X	X	X	X	X	X	X	X
Anisoyl Chloride	V3819-75	X	X	X	X	1	1	X	X	X	X	X	X	X	X	X	X	X	X
AN-O-3 Grade M	N0674-70	1	1	4	1	1	1	1	2	4	1	1	4	4	4	4	2	1	2
AN-O-366	N0674-70	1	1	4	1	1	1	2	2	4	1	1	4	4	4	4	2	1	4
AN-O-6	N0674-70	1	1	4	1	1	1	1	2	4	1	1	4	4	4	4	2	1	4
Ansul Ether 161 or 181	V3819-75	3	3	3	4	1	1	3	4	4	4	2	3	4	4	4	4	3	4
Anthracene	V1164-75	2	2	4	1	1	1	X	4	4	4	3	4	4	4	4	4	2	X
Anthranilic Acid	V3819-75	X	X	X	X	1	1	X	X	X	X	X	X	X	X	X	X	X	X
Anthraquinone	V3819-75	X	X	X	X	2	1	X	X	X	X	X	X	X	X	X	X	X	X
Anti-freeze Solutions	E0540-80	3	3	1	3	1	1	X	1	1	4	4	1	1	1	1	1	1	2
Antimony Chloride	N0674-70	1	1	4	1	1	1	1	2	4	1	1	4	4	4	4	2	1	4
Antimony Pentachloride	N0674-70	1	1	4	1	1	1	1	2	4	1	1	4	4	4	4	2	1	4
Antimony Pentafluoride	V3819-75	X	X	X	X	2	2	X	X	X	X	X	X	X	X	X	X	X	X
Antimony Sulfate	V3819-75	X	X	X	X	1	1	X	X	X	X	X	X	X	X	X	X	X	X
Antimony Tribromide	N0674-70	1	1	4	1	1	1	1	2	4	1	1	4	4	4	4	2	1	4
Antimony Trichloride	N0674-70	1	1	4	1	1	1	1	2	4	1	1	4	4	4	4	2	1	4
Antimony Trifluoride	N0674-70	1	1	4	1	1	1	1	2	4	1	1	4	4	4	4	2	1	4
Antimony Trioxide	N0674-70	1	1	4	1	1	1	1	2	4	1	1	4	4	4	4	2	1	4
AN-VV-O-366b Hydr. Fluid	N0674-70	1	1	4	1	1	1	1	2	4	2	2	4	4	4	4	2	1	4
Aqua Regia	V3819-75	4	3	3	2	2	2	3	4	X	X	X	X	X	X	X	X	X	X
Arachidic Acid	V3819-75	X	X	X	X	1	1	X	X	X	X	X	X	X	X	X	X	X	X
Argon	B0612-70	1	1	1	1	1	1	1	1	1	1	1	1	1	1	1	1	1	1
Armor All	N0674-70	X	X	X	X	X	X	X	X	X	X	X	X	X	X	X	X	X	X
Aroclor, 1248	V1164-75	3	3	2	1	1	1	1	4	4	4	4	2	4	4	4	4	2	2
Aroclor, 1254	V1164-75	4	4	2	1	1	1	1	4	4	4	4	4	4	4	4	4	2	3

Approximate Service Temperature Ranges for Commonly Used Basic Polymer Types*

Nitrile (General Service)	-34°C to 121°C (-30°F to 250°F)*	AFLAS	-9°C to 232°C (15°F to 450°F)*
Nitrile (Low Temperature)	-55°C to 107°C (-65°F to 225°F)*	Neoprene	-51°C to 107°C (-60°F to 225°F)*
Hydrogenated Nitrile	-32°C to 149°C (-23°F to 300°F)*	Polyacrylate	-21°C to 177°C (-5°F to 350°F)*
Ethylene Propylene	-57°C to 121°C (-70°F to 250°F)*	Polyurethane	-40°C to 82°C (-40°F to 180°F)*
Fluorocarbon	-26°C to 205°C (-15°F to 400°F)*	Butyl	-59°C to 120°C (-75°F to 250°F)*
Hifluor	-26°C to 205°C (-15°F to 400°F)*	Fluorosilicone	-73°C to 177°C (-100°F to 350°F)*
Perfluoroelastomer (Parofluor)	-26°C to 320°C (-15°F to 608°F)*	Silicone	-115°C to 232°C (-175°F to 450°F)*

NOTE: *These temperature ranges will apply to the majority of media for which the material is potentially recommended. With some media however, the service temperature range may be significantly different. ALWAYS TEST UNDER ACTUAL SERVICE CONDITIONS.

WARNING: These products can expose you to chemicals including carbon black (airborne and extracts), antimony trioxide, titanium dioxide, silica (crystalline), di(2-ethylhexyl) phthalate, ethylene thiourea, acrylonitrile, 1,3-butadiene, epichlorohydrin, toluenediisocyanate, tetrafluoroethylene, ethylbenzene, formaldehyde, furfuryl alcohol, glass fibers, methyl isobutyl ketone, nickel (metallic and compounds), lead and lead compounds which are known to the State of California to cause cancer; and 1,3-butadiene, epichlorohydrin, di(2-ethylhexyl)phthalate, di-isodecyl phthalate, ethylene thiourea, methyl isobutyl ketone, methanol, toluene, lead and lead compounds which are known to the State of California to cause birth defects and other reproductive harm. For more information go to www.P65Warnings.ca.gov.

COMPOUND COMPATIBILITY RATING
 1 - Satisfactory
 2 - Fair (usually OK for static seal)
 3 - Doubtful (sometimes OK for static seal)
 4 - Unsatisfactory
 x - Insufficient Data

	Recommended	Nitrile NBR	Hydrogenated Nitrile HNBR	Ethylene Propylene EPDM	Fluorocarbon FKM	Hifluor FKM	Perfluoroelastomer FFKM	Aflas (TFE/Propylene) FEPDM	Neoprene/Chloroprene CR	Styrene-Butadiene SBR	Polyacrylate ACM	Polyurethane AU, EU	Butyl IIR	Butadiene BR	Isoprene IR	Natural Rubber NR	Hypalon CSM	Fluorosilicone FVMQ	Silicone MQ, VMQ, PVMQ
Aroclor, 1260	V1164-75	1	1	X	1	1	1	1	1	1	4	4	1	1	1	1	1	1	1
Aromatic Fuel -50%	V1164-75	2	2	4	1	1	1	2	4	4	4	4	4	4	4	4	4	2	4
Arsenic Acid	E0540-80	1	1	1	1	1	1	1	1	3	3	1	1	1	2	1	1	1	
Arsenic Oxide	V3819-75	X	X	X	X	1	1	X	X	X	X	X	X	X	X	X	X	X	X
Arsenic Trichloride	N0674-70	1	1	4	4	1	1	X	1	X	X	X	X	X	X	X	X	X	X
Arsenic Trioxide	N0674-70	1	1	4	4	1	1	X	1	X	X	X	X	X	X	X	X	X	X
Arsenic Trisulfide	N0674-70	1	1	4	4	1	1	X	1	X	X	X	X	X	X	X	X	X	X
Arsenites	V3819-75	X	X	X	X	1	1	X	X	X	X	X	X	X	X	X	X	X	X
Arsine	V3819-75	X	X	X	X	1	1	X	X	X	X	X	X	X	X	X	X	X	X
Aryl Orthosilicate	V3819-75	X	X	X	X	1	1	X	X	X	X	X	X	X	X	X	X	X	X
Ascorbic Acid	E0540-80	3	3	1	3	1	1	X	1	1	4	4	1	1	1	1	1	1	2
Askarel Transformer Oil	V1164-75	2	2	4	1	1	1	2	4	4	4	4	4	4	4	4	4	2	4
Aspartic Acid	E0540-80	3	3	1	3	1	1	X	1	1	4	4	1	1	1	1	1	1	2
Asphalt	V1164-75	2	2	4	1	1	1	2	2	4	2	2	4	4	4	4	2	2	4
ASTM Oil, No. 1	N0674-70	1	1	4	1	1	1	1	4	1	1	4	4	4	4	4	2	1	1
ASTM Oil, No. 2	N0674-70	1	1	4	1	1	1	2	4	1	2	4	4	4	4	4	4	1	4
ASTM Oil, No. 3	N0674-70	1	1	4	1	1	1	1	4	4	1	2	4	4	4	4	4	1	3
ASTM Oil, No. 4	V1164-75	2	2	4	1	1	1	1	4	4	2	4	4	4	4	4	4	2	4
ASTM Oil, No. 5	V1164-75	1	1	4	1	1	1	1	2	X	X	X	X	X	X	X	X	X	X
ASTM Reference Fuel A	N0674-70	1	1	4	1	1	1	1	2	4	2	1	4	4	4	4	2	1	4
ASTM Reference Fuel B	N1500-75	1	1	4	1	1	1	1	4	4	4	2	4	4	4	4	4	1	4
ASTM Reference Fuel C	V1164-75	2	2	4	1	1	1	1	4	4	4	4	4	4	4	4	4	2	4
ASTM Reference Fuel D	V1164-75	2	2	4	1	1	1	4	4	X	X	X	X	X	X	X	X	X	X
ATL-857	V1164-75	2	2	4	1	1	1	1	4	4	2	4	4	4	4	4	4	2	4
Atlantic Dominion F	N0674-70	1	1	4	1	1	1	2	2	4	1	2	4	4	4	4	4	1	4
Atlantic Utro Gear-e	N0674-70	1	1	4	1	1	1	1	2	X	X	X	X	X	X	X	X	X	X
Atlantic Utro Gear-EP Lube	V1164-75	1	1	4	1	1	1	2	2	4	1	1	4	4	4	4	4	1	4
Aure 903R (Mobil)	N0304-75	1	1	4	1	1	1	2	2	4	1	1	4	4	4	2	4	4	4
AUREX 256	V3819-75	X	X	X	X	1	1	X	X	X	X	X	X	X	X	X	X	X	X
Automatic Transmission Fluid	N0674-70	1	1	4	1	1	1	2	2	4	1	2	4	4	4	4	3	X	4
Automotive Brake Fluid	E0667-70	3	3	1	4	1	1	2	2	1	4	4	2	X	X	X	2	4	3
AXAREL 9100	V3819-75	X	X	X	X	1	1	X	X	X	X	X	X	X	X	X	X	X	X
Azobenzene	V3819-75	X	X	X	X	1	1	X	X	X	X	X	X	X	X	X	X	X	X
- B -																			
Bardol B	V1164-75	4	4	4	1	1	1	2	4	4	4	4	4	4	4	4	4	2	4
Barium Carbonate	E0540-80	3	3	1	3	1	1	X	1	1	4	4	1	1	1	1	1	1	2
Barium Chlorate	E0540-80	3	3	1	3	1	1	X	1	1	4	4	1	1	1	1	1	1	2
Barium Chloride	N0674-70	1	1	1	1	1	1	1	1	1	1	1	1	1	1	1	1	1	1
Barium Cyanide	N0674-70	1	1	1	1	1	1	1	1	1	1	1	1	1	1	1	1	1	1

Approximate Service Temperature Ranges for Commonly Used Basic Polymer Types*

Nitrile (General Service)	-34°C to 121°C (-30°F to 250°F)*	AFLAS	-9°C to 232°C (15°F to 450°F)*
Nitrile (Low Temperature)	-55°C to 107°C (-65°F to 225°F)*	Neoprene	-51°C to 107°C (-60°F to 225°F)*
Hydrogenated Nitrile	-32°C to 149°C (-23°F to 300°F)*	Polyacrylate	-21°C to 177°C (-5°F to 350°F)*
Ethylene Propylene	-57°C to 121°C (-70°F to 250°F)*	Polyurethane	-40°C to 82°C (-40°F to 180°F)*
Fluorocarbon	-26°C to 205°C (-15°F to 400°F)*	Butyl	-59°C to 120°C (-75°F to 250°F)*
Hifluor	-26°C to 205°C (-15°F to 400°F)*	Fluorosilicone	-73°C to 177°C (-100°F to 350°F)*
Perfluoroelastomer (Parofluor)	-26°C to 320°C (-15°F to 608°F)*	Silicone	-115°C to 232°C (-175°F to 450°F)*

NOTE: *These temperature ranges will apply to the majority of media for which the material is potentially recommended. With some media however, the service temperature range may be significantly different. ALWAYS TEST UNDER ACTUAL SERVICE CONDITIONS.

WARNING: These products can expose you to chemicals including carbon black (airborne and extracts), antimony trioxide, titanium dioxide, silica (crystalline), di(2-ethylhexyl) phthalate, ethylene thiourea, acrylonitrile, 1,3-butadiene, epichlorohydrin, toluenediisocyanate, tetrafluoroethylene, ethylbenzene, formaldehyde, furfuryl alcohol, glass fibers, methyl isobutyl ketone, nickel (metallic and compounds), lead and lead compounds which are known to the State of California to cause cancer; and 1,3-butadiene, epichlorohydrin, di(2-ethylhexyl)phthalate, di-isodecyl phthalate, ethylene thiourea, methyl isobutyl ketone, methanol, toluene, lead and lead compounds which are known to the State of California to cause birth defects and other reproductive harm. For more information go to www.P65Warnings.ca.gov.

Compatibility Tables for Gases, Fluids, Solids

COMPOUND COMPATIBILITY RATING
 1 - Satisfactory
 2 - Fair (usually OK for static seal)
 3 - Doubtful (sometimes OK for static seal)
 4 - Unsatisfactory
 x - Insufficient Data

	Recommended	Nitrile NBR	Hydrogenated Nitrile HNBR	Ethylene Propylene EPDM	Fluorocarbon FKM	Hifluor FKM	Perfluoroelastomer FFKM	Aflas (TFE/Propylene) FEPDM	Neoprene/Chloroprene CR	Styrene-Butadiene SBR	Polyacrylate ACM	Polyurethane AU, EU	Butyl IIR	Butadiene BR	Isoprene IR	Natural Rubber NR	Hypalon CSM	Fluorosilicone FVMQ	Silicone MQ, VMQ, PVMQ
Barium Hydroxide	N0674-70	1	1	1	1	1	1	1	1	1	4	4	1	1	1	1	1	1	1
Barium Iodide	N0674-70	1	1	1	1	1	1	1	1	1	1	1	1	1	1	1	1	1	1
Barium Nitrate	E0540-80	3	3	1	3	1	1	X	1	1	4	4	1	1	1	1	1	1	2
Barium Oxide	N0674-70	1	1	1	1	1	1	1	1	1	4	4	1	1	1	1	1	1	1
Barium Peroxide	E0540-80	3	3	1	3	1	1	X	1	1	4	4	1	1	1	1	1	1	2
Barium Polysulfide	E0540-80	3	3	1	3	1	1	X	1	1	4	4	1	1	1	1	1	1	2
Barium Salts	N0674-70	1	1	1	1	1	1	1	1	1	1	1	1	1	1	1	1	1	1
Barium Sulfate	N0674-70	1	1	1	1	1	1	1	X	X	X	X	X	X	X	X	X	X	X
Barium Sulfide	N0674-70	1	1	1	1	1	1	1	2	4	1	1	2	1	1	1	1	1	1
Bayol 35	N0674-70	1	1	4	1	1	1	2	2	4	1	2	4	4	4	4	4	1	4
Bayol D	N0674-70	1	1	4	1	1	1	2	2	4	1	4	4	4	4	4	4	1	4
Beer	E3609-70	1	1	1	1	1	1	1	1	1	4	2	1	1	1	1	1	1	1
Beet Sugar Liquids	N0674-70	1	1	1	1	1	1	1	1	X	X	X	X	X	X	X	X	X	X
Beet Sugar Liquors	N0674-70	1	1	1	1	1	1	2	1	4	4	1	1	1	1	1	1	1	1
Benzaldehyde	E0540-80	4	4	1	4	1	1	2	4	4	4	4	1	4	4	4	1	4	2
Benzaldehyde Disulfonic Acid	FF200-75	X	X	X	X	1	1	X	X	X	X	X	X	X	X	X	X	X	X
Benzamide	V1164-75	2	2	4	1	1	1	X	4	4	4	3	4	4	4	4	4	2	X
Benzanthrone	V1164-75	2	2	4	1	1	1	X	4	4	4	3	4	4	4	4	4	2	X
Benzene	V1164-75	4	4	4	1	1	1	2	4	4	4	4	4	4	4	4	4	3	4
Benzene Hexachloride	V3819-75	X	X	X	X	1	1	X	X	X	X	X	X	X	X	X	X	X	X
Benzenesulfonic Acid 10%	V1164-75	4	4	4	1	1	1	2	2	4	4	4	4	4	4	4	1	2	4
Benzidine	V1164-75	2	2	4	1	1	1	X	4	4	4	3	4	4	4	4	4	2	X
Benzidine 3 Sulfonic Acid	V1164-75	2	2	4	1	1	1	X	4	4	4	3	4	4	4	4	4	2	X
Benzil	V1164-75	2	2	4	1	1	1	X	4	4	4	3	4	4	4	4	4	2	X
Benzilic Acid	V1164-75	2	2	4	1	1	1	X	4	4	4	3	4	4	4	4	4	2	X
Benzine (Ligroin)	N0674-70	1	1	4	1	1	1	2	2	4	1	2	4	4	4	4	3	1	4
Benzocatechol	V1164-75	2	2	4	1	1	1	X	4	4	4	3	4	4	4	4	4	2	X
Benzochloride	V1164-75	4	4	1	1	1	1	1	4	4	4	X	2	4	4	4	4	1	X
Benzoic Acid	V1164-75	4	4	4	1	1	1	2	4	4	4	4	4	4	4	4	4	2	4
Benzoin	V1164-75	2	2	4	1	1	1	X	4	4	4	3	4	4	4	4	4	2	X
Benzonitrile	E0540-80	3	3	1	3	1	1	X	1	1	4	4	1	1	1	1	1	1	2
Benzophenone	V1164-75	X	X	2	1	1	1	2	X	4	4	4	2	4	4	X	X	1	X
Benzoquinone	V1164-75	X	X	2	1	1	1	2	X	4	4	4	2	4	4	X	X	X	X
Benzotrichloride	V1164-75	4	4	1	1	1	1	4	X	X	X	X	X	X	X	X	X	X	X
Benzotrifluoride	V1164-75	4	4	1	1	1	1	4	X	X	X	X	X	X	X	X	X	X	X
Benzoyl Chloride	V1164-75	X	X	X	1	1	1	X	4	4	4	3	4	4	4	4	4	2	X
Benzoyl Peroxide	V3819-75	X	X	X	X	1	1	X	X	X	X	X	X	X	X	X	X	X	X
Benzoylsulfonic Acid	V1164-75	2	2	4	1	1	1	X	4	4	4	3	4	4	4	4	4	2	X
Benzyl Acetate	E0540-80	3	3	1	3	2	1	X	1	1	4	4	1	1	1	1	1	1	2
Benzyl Alcohol	V1164-75	4	4	2	1	1	1	2	2	4	4	4	2	4	4	4	2	2	2

Approximate Service Temperature Ranges for Commonly Used Basic Polymer Types*

Nitrile (General Service)	-34°C to 121°C (-30°F to 250°F)*	AFLAS	-9°C to 232°C (15°F to 450°F)*
Nitrile (Low Temperature)	-55°C to 107°C (-65°F to 225°F)*	Neoprene	-51°C to 107°C (-60°F to 225°F)*
Hydrogenated Nitrile	-32°C to 149°C (-23°F to 300°F)*	Polyacrylate	-21°C to 177°C (-5°F to 350°F)*
Ethylene Propylene	-57°C to 121°C (-70°F to 250°F)*	Polyurethane	-40°C to 82°C (-40°F to 180°F)*
Fluorocarbon	-26°C to 205°C (-15°F to 400°F)*	Butyl	-59°C to 120°C (-75°F to 250°F)*
Hifluor	-26°C to 205°C (-15°F to 400°F)*	Fluorosilicone	-73°C to 177°C (-100°F to 350°F)*
Perfluoroelastomer (Parofluor)	-26°C to 320°C (-15°F to 608°F)*	Silicone	-115°C to 232°C (-175°F to 450°F)*

NOTE: *These temperature ranges will apply to the majority of media for which the material is potentially recommended. With some media however, the service temperature range may be significantly different. ALWAYS TEST UNDER ACTUAL SERVICE CONDITIONS.

WARNING: These products can expose you to chemicals including carbon black (airborne and extracts), antimony trioxide, titanium dioxide, silica (crystalline), di(2-ethylhexyl) phthalate, ethylene thiourea, acrylonitrile, 1,3-butadiene, epichlorohydrin, toluenediisocyanate, tetrafluoroethylene, ethylbenzene, formaldehyde, furfuryl alcohol, glass fibers, methyl isobutyl ketone, nickel (metallic and compounds), lead and lead compounds which are known to the State of California to cause cancer; and 1,3-butadiene, epichlorohydrin, di(2-ethylhexyl)phthalate, di-isodecyl phthalate, ethylene thiourea, methyl isobutyl ketone, methanol, toluene, lead and lead compounds which are known to the State of California to cause birth defects and other reproductive harm. For more information go to www.P65Warnings.ca.gov.

COMPOUND COMPATIBILITY RATING
 1 - Satisfactory
 2 - Fair (usually OK for static seal)
 3 - Doubtful (sometimes OK for static seal)
 4 - Unsatisfactory
 x - Insufficient Data

	Recommended	Nitrile NBR	Hydrogenated Nitrile HNBR	Ethylene Propylene EPDM	Fluorocarbon FKM	Hifluor FKM	Perfluoroelastomer FFKM	Aflas (TFE/Propylene) FFKM	Neoprene/Chloroprene CR	Styrene-Butadiene SBR	Polyacrylate ACM	Polyurethane AU, EU	Butyl IIR	Butadiene BR	Isoprene IR	Natural Rubber NR	Hypalon CSM	Fluorosilicone FVMQ	Silicone MQ, VMQ, PVMQ
Benzyl Amine	FF500-75	X	X	X	X	1	1	X	X	X	X	X	X	X	X	X	X	X	X
Benzyl Benzoate	V1164-75	4	4	4	1	1	1	2	4	4	4	4	2	4	4	4	4	1	4
Benzyl Bromide	V1164-75	4	4	4	1	1	1	2	4	4	4	4	4	4	4	4	4	1	4
Benzyl Butyl Phthalate	E0540-80	3	3	1	3	1	1	X	1	1	4	4	1	1	1	1	1	1	2
Benzyl Chloride	V1164-75	4	4	4	1	1	1	2	4	4	4	4	4	4	4	4	4	1	4
Benzyl Phenol	V1164-75	2	2	4	1	1	1	X	4	4	4	3	4	4	4	4	4	2	X
Benzyl Salicylate	V1164-75	2	2	4	1	1	1	X	4	4	4	3	4	4	4	4	4	2	X
Beryllium Chloride	N0674-70	1	1	1	1	1	1	1	3	3	3	3	1	3	3	3	3	3	3
Beryllium Fluoride	N0674-70	1	1	1	1	1	1	1	3	3	3	3	1	3	3	3	3	3	3
Beryllium Oxide	N0674-70	1	1	1	1	1	1	1	3	3	3	3	1	3	3	3	3	3	3
Beryllium Sulfate	E0540-80	3	3	1	3	1	1	X	1	1	4	4	1	1	1	1	1	1	2
Bismuth Carbonate	E0540-80	3	3	1	3	1	1	X	1	1	4	4	1	1	1	1	1	1	2
Bismuth Nitrate	E0540-80	3	3	1	3	1	1	X	1	1	4	4	1	1	1	1	1	1	2
Bismuth Oxychloride	E0540-80	3	3	1	3	1	1	X	1	1	4	4	1	1	1	1	1	1	2
Bittern	V3819-75	X	X	X	X	1	1	X	X	X	X	X	X	X	X	X	X	X	X
Black Liquor	E0540-80	2	X	1	1	4	3	1	1	X	X	X	X	X	X	X	X	X	X
Black Point 77	N0674-70	1	1	1	1	1	1	1	3	3	3	3	1	3	3	3	3	3	3
Blast Furnace Gas	S0604-70	4	4	4	1	1	1	2	4	4	4	4	4	4	4	4	4	2	1
Bleach Liquor	E0540-80	3	3	1	1	1	1	1	2	3	4	4	1	2	2	3	1	2	2
Bleach Solutions	E0540-80	X	X	1	1	1	1	X	X	X	X	X	X	X	X	X	X	X	X
Blood	E3609-70	2	0	1	1	1	1	3	1	X	X	X	X	X	X	X	X	X	2
Borax	E0540-80	2	2	1	1	1	1	1	4	2	2	1	1	2	2	2	4	2	2
Borax Solutions	E0540-80	X	X	1	1	1	1	X	X	X	X	X	X	X	X	X	X	X	X
Bordeaux Mixture	E0540-80	2	2	1	1	1	1	1	2	2	4	4	1	2	2	2	1	2	2
Boric Acid	N0674-70	1	1	1	1	1	1	1	1	1	4	1	1	1	1	1	1	1	1
Boric Oxide	E0540-80	3	3	1	3	2	1	X	1	1	4	4	1	1	1	1	1	1	2
Borneol	V1164-75	2	2	4	1	1	1	X	4	4	4	3	4	4	4	4	4	2	X
Bornyl Acetate	V1164-75	2	2	4	1	2	1	X	4	4	4	3	4	4	4	4	4	2	X
Bornyl Chloride	V1164-75	2	2	4	1	1	1	X	4	4	4	3	4	4	4	4	4	2	X
Bornyl Formate	V1164-75	2	2	4	1	1	1	X	4	4	4	3	4	4	4	4	4	2	X
Boron Fluids (HEF)	V1164-75	2	2	4	1	1	1	2	4	4	4	4	4	4	4	4	4	2	4
Boron Hydride	V3819-75	X	X	X	X	1	1	X	X	X	X	X	X	X	X	X	X	X	X
Boron Phosphate	V3819-75	X	X	X	X	1	1	X	X	X	X	X	X	X	X	X	X	X	X
Boron Tribromide	V3819-75	X	X	X	X	1	1	X	X	X	X	X	X	X	X	X	X	X	X
Boron Trichloride	V3819-75	X	X	X	X	1	1	X	X	X	X	X	X	X	X	X	X	X	X
Boron Trifluoride	V3819-75	X	X	X	X	1	1	X	X	X	X	X	X	X	X	X	X	X	X
Boron Trioxide	V3819-75	X	X	X	X	1	1	X	X	X	X	X	X	X	X	X	X	X	X
BP Turbine Oil 2197	VM835-75	4	4	4	3	1	1	2	4	4	4	4	4	4	4	4	4	4	4
Brake Fluid DOT 3 (Glycol Type)	E0667-70	3	3	1	4	1	1	2	2	1	X	4	2	X	X	X	2	4	3
Brake Fluid DOT 4	E0667-70	3	3	1	4	1	1	2	2	1	X	4	2	X	X	X	2	4	3

Approximate Service Temperature Ranges for Commonly Used Basic Polymer Types*

Nitrile (General Service)	-34°C to 121°C (-30°F to 250°F)*	AFLAS	-9°C to 232°C (15°F to 450°F)*
Nitrile (Low Temperature)	-55°C to 107°C (-65°F to 225°F)*	Neoprene	-51°C to 107°C (-60°F to 225°F)*
Hydrogenated Nitrile	-32°C to 149°C (-23°F to 300°F)*	Polyacrylate	-21°C to 177°C (-5°F to 350°F)*
Ethylene Propylene	-57°C to 121°C (-70°F to 250°F)*	Polyurethane	-40°C to 82°C (-40°F to 180°F)*
Fluorocarbon	-26°C to 205°C (-15°F to 400°F)*	Butyl	-59°C to 120°C (-75°F to 250°F)*
Hifluor	-26°C to 205°C (-15°F to 400°F)*	Fluorosilicone	-73°C to 177°C (-100°F to 350°F)*
Perfluoroelastomer (Parofluor)	-26°C to 320°C (-15°F to 608°F)*	Silicone	-115°C to 232°C (-175°F to 450°F)*

NOTE: *These temperature ranges will apply to the majority of media for which the material is potentially recommended. With some media however, the service temperature range may be significantly different. ALWAYS TEST UNDER ACTUAL SERVICE CONDITIONS.

WARNING: These products can expose you to chemicals including carbon black (airborne and extracts), antimony trioxide, titanium dioxide, silica (crystalline), di(2-ethylhexyl) phthalate, ethylene thiourea, acrylonitrile, 1,3-butadiene, epichlorohydrin, toluenediisocyanate, tetrafluoroethylene, ethylbenzene, formaldehyde, furfuryl alcohol, glass fibers, methyl isobutyl ketone, nickel (metallic and compounds), lead and lead compounds which are known to the State of California to cause cancer; and 1,3-butadiene, epichlorohydrin, di(2-ethylhexyl)phthalate, di-isodecyl phthalate, ethylene thiourea, methyl isobutyl ketone, methanol, toluene, lead and lead compounds which are known to the State of California to cause birth defects and other reproductive harm. For more information go to www.P65Warnings.ca.gov.

Compatibility Tables for Gases, Fluids, Solids

COMPOUND COMPATIBILITY RATING
 1 - Satisfactory
 2 - Fair (usually OK for static seal)
 3 - Doubtful (sometimes OK for static seal)
 4 - Unsatisfactory
 x - Insufficient Data

	Recommended	Nitrile NBR	Hydrogenated Nitrile HNBR	Ethylene Propylene EPDM	Fluorocarbon FKM	Hifluor FKM	Perfluoroelastomer FFKM	Aflas (TFE/Propylene) FFKM	Neoprene/Chloroprene CR	Styrene-Butadiene SBR	Polyacrylate ACM	Polyurethane AU, EU	Butyl IIR	Butadiene BR	Isoprene IR	Natural Rubber NR	Hypalon CSM	Fluorosilicone FVMQ	Silicone MQ, VMQ, PVMQ
Brake Fluid DOT 5	E0667-70	2	1	1	1	1	1	1	2	X	X	X	1	X	X	X	X	3	4
Bray GG-130	V1164-75	2	2	4	1	1	1	2	4	4	2	4	4	4	4	4	4	2	4
Brayco 719-R (VV-H-910)	E0603-70	3	3	1	4	1	1	2	2	X	4	4	2	2	2	2	2	2	2
Brayco 885 (MIL-L-6085A)	V1164-75	2	2	4	1	1	1	2	4	4	2	1	4	4	4	4	4	2	4
Brayco 910	E0540-80	2	2	1	4	1	1	2	2	2	3	3	1	1	1	1	1	4	4
Bret 710	E0540-80	2	2	1	4	1	1	2	2	2	3	3	1	1	1	1	1	4	4
Brine	N0674-70	1	1	1	1	1	1	X	X	X	X	X	X	X	X	X	X	X	X
Brine (Seawater)	N0674-70	1	1	1	1	1	1	2	X	X	X	X	X	X	X	X	X	X	X
Brom - 113	V3819-75	3	3	4	X	X	X	3	4	4	X	X	4	X	X	X	4	X	4
Brom - 114	V3819-75	2	2	4	2	1	1	3	2	4	X	X	4	4	4	4	2	X	4
Bromic Acid	E0540-80	3	3	1	3	1	1	X	1	1	4	4	1	1	1	1	1	1	2
Bromine	V1164-75	4	4	4	1	1	1	2	4	4	4	4	4	4	4	4	4	2	4
Bromine Pentafluoride	Factory	4	4	4	4	2	2	3	4	4	4	4	4	4	4	4	4	4	4
Bromine Trifluoride	Factory	4	4	4	4	2	2	3	4	4	4	4	4	4	4	4	4	4	4
Bromine Water	V1164-75	4	4	2	1	1	1	3	4	4	4	4	4	4	4	4	1	2	4
Bromobenzene	V1164-75	4	4	4	1	1	1	2	4	4	4	4	4	4	4	4	4	1	4
Bromobenzene Cyanide	E0540-80	3	3	1	3	1	1	X	1	1	4	4	1	1	1	1	1	1	2
Bromochlorotrifluoroethane (Halothane)	V1164-75	4	4	4	1	1	1	2	4	4	4	4	4	4	4	4	4	2	4
Bromoform	V1164-75	2	2	4	1	1	1	X	4	4	4	3	4	4	4	4	4	2	X
Bromomethane (Methyl Bromide)	V1164-75	2	2	4	1	1	1	1	4	4	3	X	4	4	4	4	4	1	X
Bromotrifluoroethylene (BFE)	V3819-75	X	X	X	X	1	1	X	X	X	X	X	X	X	X	X	X	X	X
Bromotrifluoromethane (F-13B1)	V3819-75	X	X	X	X	2	2	X	X	X	X	X	X	X	X	X	X	X	X
Brucine Sulfate	E0540-80	3	3	1	3	1	1	X	1	1	4	4	1	1	1	1	1	1	2
Buffered Oxide Etchants	V3819-75	X	X	X	X	1	1	X	X	X	X	X	X	X	X	X	X	X	X
Bunker Oil	N0674-70	1	1	4	1	1	1	2	4	4	1	2	4	4	4	4	4	1	2
Bunker's "C" (Fuel Oil)	N0674-70	1	X	X	1	1	1	X	X	X	X	X	X	X	X	X	X	X	X
Butadiene (Monomer)	V1164-75	4	4	4	1	1	1	2	4	4	4	4	4	4	4	4	4	1	4
Butane	N0674-70	1	1	4	1	1	1	2	1	3	1	1	4	4	4	4	2	3	4
Butane, 2, 2-Dimethyl	N0674-70	1	1	4	1	1	1	2	2	3	1	4	4	4	4	4	2	3	4
Butane, 2, 3-Dimethyl	N0674-70	1	1	4	1	1	1	2	2	3	1	4	4	4	4	4	2	3	4
Butanedial	E0540-80	3	3	1	3	1	1	X	1	1	4	4	1	1	1	1	1	1	2
Butanol (Butyl Alcohol)	N0674-70	1	1	2	1	1	1	1	1	1	4	4	2	1	1	1	1	1	2
Butene 2-Ethyl (1-Butene 2-Ethyl)	N0674-70	1	1	4	1	1	1	1	4	4	1	4	4	4	4	4	4	3	4
Butter	E1028-70	1	1	1	1	1	1	1	2	X	X	1	3	X	X	X	X	2	
Butter-Animal Fat	N0508-75	1	1	1	1	1	1	1	2	4	1	1	2	4	4	4	2	1	2
Butyl Acetate or n-Butyl Acetate	E0540-80	4	4	2	4	1	1		4	4	4	2	4	4	4	4	4	4	4
Butyl Acetyl Ricinoleate	E0540-80	2	2	1	1	1	1	1	2	4	X	4	1	4	4	4	2	2	X
Butyl Acrylate	E0540-80	4	4	1	4	1	1	4	4	4	4	X	4	4	4	4	4	4	2
Butyl Alcohol	N0674-70	1	1	2	1	1	1	1	1	1	4	4	2	1	1	1	1	1	2
Butyl Alcohol (Secondary)	V1164-75	2	2	2	1	1	1	1	2	2	4	4	2	2	2	2	2	2	2

Approximate Service Temperature Ranges for Commonly Used Basic Polymer Types*

Nitrile (General Service)	-34°C to 121°C (-30°F to 250°F)*	AFLAS	-9°C to 232°C (15°F to 450°F)*
Nitrile (Low Temperature)	-55°C to 107°C (-65°F to 225°F)*	Neoprene	-51°C to 107°C (-60°F to 225°F)*
Hydrogenated Nitrile	-32°C to 149°C (-23°F to 300°F)*	Polyacrylate	-21°C to 177°C (-5°F to 350°F)*
Ethylene Propylene	-57°C to 121°C (-70°F to 250°F)*	Polyurethane	-40°C to 82°C (-40°F to 180°F)*
Fluorocarbon	-26°C to 205°C (-15°F to 400°F)*	Butyl	-59°C to 120°C (-75°F to 250°F)*
Hifluor	-26°C to 205°C (-15°F to 400°F)*	Fluorosilicone	-73°C to 177°C (-100°F to 350°F)*
Perfluoroelastomer (Parofluor)	-26°C to 320°C (-15°F to 608°F)*	Silicone	-115°C to 232°C (-175°F to 450°F)*

NOTE: *These temperature ranges will apply to the majority of media for which the material is potentially recommended. With some media however, the service temperature range may be significantly different. ALWAYS TEST UNDER ACTUAL SERVICE CONDITIONS.



WARNING: These products can expose you to chemicals including carbon black (airborne and extracts), antimony trioxide, titanium dioxide, silica (crystalline), di(2-ethylhexyl) phthalate, ethylene thiourea, acrylonitrile, 1,3-butadiene, epichlorohydrin, toluenediisocyanate, tetrafluoroethylene, ethylbenzene, formaldehyde, furfuryl alcohol, glass fibers, methyl isobutyl ketone, nickel (metallic and compounds), lead and lead compounds which are known to the State of California to cause cancer; and 1,3-butadiene, epichlorohydrin, di(2-ethylhexyl)phthalate, di-isodecyl phthalate, ethylene thiourea, methyl isobutyl ketone, methanol, toluene, lead and lead compounds which are known to the State of California to cause birth defects and other reproductive harm. For more information go to www.P65Warnings.ca.gov.

COMPOUND COMPATIBILITY RATING
 1 - Satisfactory
 2 - Fair (usually OK for static seal)
 3 - Doubtful (sometimes OK for static seal)
 4 - Unsatisfactory
 x - Insufficient Data

	Recommended	Nitrile NBR	Hydrogenated Nitrile HNBR	Ethylene Propylene EPDM	Fluorocarbon FKM	Hifluor FKM	Perfluoroelastomer FFKM	Aflas (TFE/Propylene) FEPDM	Neoprene/Chloroprene CR	Styrene-Butadiene SBR	Polyacrylate ACM	Polyurethane AU, EU	Butyl IIR	Butadiene BR	Isoprene IR	Natural Rubber NR	Hypalon CSM	Fluorosilicone FVMQ	Silicone MQ, VMQ, PVMQ
Butyl Alcohol (Tertiary)	V1164-75	2	2	2	1	1	1	1	2	2	4	4	2	2	2	2	2	2	2
Butyl Amine or N-Butyl Amine	N0674-70	1	1	3	4	1	1	3	4	4	4	4	4	4	4	4	4	4	4
Butyl Benzoate	E0540-80	3	3	1	3	1	1	X	1	1	4	4	1	1	1	1	1	1	2
Butyl Benzoate or n-Butyl Benzoate	E0540-80	4	4	1	1	1	1		4	2	4	X	1	4	4	4	4	1	X
Butyl Benzolate	V3819-75	X	X	X	X	1	1	X	X	X	X	X	X	X	X	X	X	X	X
Butyl Butyrate or n-Butyl Butyrate	E0540-80	4	4	1	1	1	1		4	4	4	X	1	4	4	4	4	1	X
Butyl Carbitol	E0540-80	4	4	1	3	1	1	2	3	4	4	X	1	4	4	4	4	2	4
Butyl Cellosolve	E0540-80	3	3	2	4	1	1	2	3	4	4	2	4	4	4	4	4	4	X
Butyl Cellosolve Acetate	E0540-80	3	3	1	3	1	1	X	1	1	4	4	1	1	1	1	1	1	2
Butyl Cellosolve Adipate	E0540-80	4	4	2	2	1	1	2	4	4	4	4	2	4	4	4	4	2	2
Butyl Chloride	N0674-70	1	1	4	1	1	1	X	2	4	1	1	4	4	4	4	2	1	2
Butyl Ether or n-Butyl Ether	V3819-75	3	3	3	4	1	1		4	4	4	3	3	4	4	4	4	3	4
Butyl Glycolate	E0540-80	3	3	1	3	1	1	X	1	1	4	4	1	1	1	1	1	1	2
Butyl Lactate	E0540-80	3	3	1	3	1	1	X	1	1	4	4	1	1	1	1	1	1	2
Butyl Laurate	E0540-80	3	3	1	3	1	1	X	1	1	4	4	1	1	1	1	1	1	2
Butyl Mercaptan (Tertiary)	V1164-75	4	4	4	1	1	1		4	4	4	4	4	4	4	4	4	X	4
Butyl Methacrylate	E0540-80	3	3	1	3	2	1	X	1	1	4	4	1	1	1	1	1	1	2
Butyl Oleate	V1164-75	4	4	2	1	1	1	2	4	4	X	X	2	4	X	4	4	2	X
Butyl Oxalate	E0540-80	3	3	1	3	1	1	X	1	1	4	4	1	1	1	1	1	1	2
Butyl Stearate	V1164-75	2	2	4	1	1	1	2	4	4	X	X	4	4	4	4	4	2	X
Butylbenzoic Acid	V1164-75	2	2	4	1	1	1	X	4	4	4	3	4	4	4	4	4	2	X
Butylene	V1164-75	2	2	4	1	1	1	2	3	4	4	4	4	4	4	4	4	2	4
Butyraldehyde	E0540-80	4	4	2	4	1	1	2	4	4	4	4	2	4	4	4	4	4	4
Butyric Acid	V1164-75	4	4	2	2	1	1	1	4	4	4	X	2	4	X	X	4	X	X
Butyric Anhydride	E0540-80	3	3	1	3	1	1	X	1	1	4	4	1	1	1	1	1	1	2
Butyrolacetone	E0540-80	3	3	1	3	2	1	X	1	1	4	4	1	1	1	1	1	1	2
Butyryl Chloride	V1164-75	2	2	4	1	1	1	X	4	4	4	3	4	4	4	4	4	2	X
- C -																			
Cadmium Chloride	E0540-80	3	3	1	3	1	1	X	1	1	4	4	1	1	1	1	1	1	2
Cadmium Cyanide	E0540-80	3	3	1	3	1	1	X	1	1	4	4	1	1	1	1	1	1	2
Cadmium Nitrate	E0540-80	3	3	1	3	1	1	X	1	1	4	4	1	1	1	1	1	1	2
Cadmium Oxide	E0540-80	3	3	1	3	1	1	X	1	1	4	4	1	1	1	1	1	1	2
Cadmium Sulfate	E0540-80	3	3	1	3	1	1	X	1	1	4	4	1	1	1	1	1	1	2
Cadmium Sulfide	E0540-80	3	3	1	3	1	1	X	1	1	4	4	1	1	1	1	1	1	2
Calcine Liquors	N0674-70	1	1	1	1	1	1	1	X	X	4	4	1	X	X	X	X	1	X
Calcium Acetate	E0540-80	2	2	1	4	1	1	2	2	4	4	4	1	4	1	1	2	4	4
Calcium Arsenate	E0540-80	3	3	1	3	1	1	X	1	1	4	4	1	1	1	1	1	1	2
Calcium Benzoate	V1164-75	2	2	4	1	1	1	X	4	4	4	3	4	4	4	4	4	2	X
Calcium Bicarbonate	E0540-80	3	3	1	3	1	1	X	1	1	4	4	1	1	1	1	1	1	2
Calcium Bisulfide	E0540-80	3	3	1	3	1	1	X	1	1	4	4	1	1	1	1	1	1	2
Calcium Bisulfite	E0540-80	2	2	1	2	1	1	1	2	2	3	3	1	4	4	4	1	3	3

Approximate Service Temperature Ranges for Commonly Used Basic Polymer Types*

Nitrile (General Service)	-34°C to 121°C (-30°F to 250°F)*	AFLAS	-9°C to 232°C (15°F to 450°F)*
Nitrile (Low Temperature)	-55°C to 107°C (-65°F to 225°F)*	Neoprene	-51°C to 107°C (-60°F to 225°F)*
Hydrogenated Nitrile	-32°C to 149°C (-23°F to 300°F)*	Polyacrylate	-21°C to 177°C (-5°F to 350°F)*
Ethylene Propylene	-57°C to 121°C (-70°F to 250°F)*	Polyurethane	-40°C to 82°C (-40°F to 180°F)*
Fluorocarbon	-26°C to 205°C (-15°F to 400°F)*	Butyl	-59°C to 120°C (-75°F to 250°F)*
Hifluor	-26°C to 205°C (-15°F to 400°F)*	Fluorosilicone	-73°C to 177°C (-100°F to 350°F)*
Perfluoroelastomer (Parofluor)	-26°C to 320°C (-15°F to 608°F)*	Silicone	-115°C to 232°C (-175°F to 450°F)*

NOTE: *These temperature ranges will apply to the majority of media for which the material is potentially recommended. With some media however, the service temperature range may be significantly different. ALWAYS TEST UNDER ACTUAL SERVICE CONDITIONS.

WARNING: These products can expose you to chemicals including carbon black (airborne and extracts), antimony trioxide, titanium dioxide, silica (crystalline), di(2-ethylhexyl) phthalate, ethylene thiourea, acrylonitrile, 1,3-butadiene, epichlorohydrin, toluenediisocyanate, tetrafluoroethylene, ethylbenzene, formaldehyde, furfuryl alcohol, glass fibers, methyl isobutyl ketone, nickel (metallic and compounds), lead and lead compounds which are known to the State of California to cause cancer; and 1,3-butadiene, epichlorohydrin, di(2-ethylhexyl)phthalate, di-isodecyl phthalate, ethylene thiourea, methyl isobutyl ketone, methanol, toluene, lead and lead compounds which are known to the State of California to cause birth defects and other reproductive harm. For more information go to www.P65Warnings.ca.gov.

Compatibility Tables for Gases, Fluids, Solids

COMPOUND COMPATIBILITY RATING
 1 - Satisfactory
 2 - Fair (usually OK for static seal)
 3 - Doubtful (sometimes OK for static seal)
 4 - Unsatisfactory
 x - Insufficient Data

	Recommended	Nitrile NBR	Hydrogenated Nitrile HNBR	Ethylene Propylene EPDM	Fluorocarbon FKM	Hifluor FKM	Perfluoroelastomer FFKM	Aflas (TFE/Propylene) FEPDM	Neoprene/Chloroprene CR	Styrene-Butadiene SBR	Polyacrylate ACM	Polyurethane AU, EU	Butyl IIR	Butadiene BR	Isoprene IR	Natural Rubber NR	Hypalon CSM	Fluorosilicone FVMQ	Silicone MQ, VMQ, PVMQ
Calcium Bromide	N0674-70	1	1	1	1	1	1	1	1	1	1	1	1	1	1	1	1	1	1
Calcium Carbide	V3819-75	X	X	X	X	1	1	X	X	X	X	X	X	X	X	X	X	X	X
Calcium Carbonate	N0674-70	1	1	1	1	1	1	1	1	1	3	3	1	1	1	1	1	1	1
Calcium Chlorate	E0540-80	3	3	1	3	1	1	X	1	1	4	4	1	1	1	1	1	1	2
Calcium Chloride	N0674-70	1	1	1	1	1	1	1	1	1	1	1	1	1	1	1	1	1	1
Calcium Chromate	E0540-80	3	3	1	3	1	1	X	1	1	4	4	1	1	1	1	1	1	2
Calcium Cyanamide	V3819-75	X	X	X	X	1	1	X	X	X	X	X	X	X	X	X	X	X	X
Calcium Cyanide	N0674-70	1	1	1	X	1	1	1	1	1	X	X	1	1	1	1	1	X	1
Calcium Fluoride	N0674-70	1	1	1	1	1	1	1	1	1	1	1	1	1	1	1	1	1	1
Calcium Gluconate	E0540-80	3	3	1	3	1	1	X	1	1	4	4	1	1	1	1	1	1	2
Calcium Hydride	N0674-70	1	1	1	1	1	1	1	1	1	1	1	1	1	1	1	1	1	1
Calcium Hydrosulfide	E0540-80	3	3	1	3	1	1	X	1	1	4	4	1	1	1	1	1	1	2
Calcium Hydroxide	N0674-70	1	1	1	1	1	1	1	1	1	4	2	1	1	1	1	1	1	1
Calcium Hypochlorite	E0540-80	2	2	1	1	1	1	1	2	2	4	4	1	2	2	2	1	2	2
Calcium Hypophosphite	E0540-80	3	3	1	3	1	1	X	1	1	4	4	1	1	1	1	1	1	2
Calcium Lactate	E0540-80	3	3	1	3	1	1	X	1	1	4	4	1	1	1	1	1	1	2
Calcium Naphthenate	V3819-75	X	X	X	X	1	1	X	X	X	X	X	X	X	X	X	X	X	X
Calcium Nitrate	N0674-70	1	1	1	1	1	1	1	1	1	1	1	1	1	1	1	1	1	2
Calcium Oxalate	E0540-80	3	3	1	3	1	1	X	1	1	4	4	1	1	1	1	1	1	2
Calcium Oxide	N0674-70	1	1	1	1	1	1	1	1	1	1	1	1	1	1	1	1	1	1
Calcium Permanganate	V3819-75	X	X	X	X	1	1	X	X	X	X	X	X	X	X	X	X	X	X
Calcium Peroxide	V3819-75	X	X	X	X	1	1	X	X	X	X	X	X	X	X	X	X	X	X
Calcium Phenolsulfonate	E0540-80	3	3	1	3	1	1	X	1	1	4	4	1	1	1	1	1	1	2
Calcium Phosphate	N0674-70	1	1	1	1	1	1	1	2	1	1	1	1	1	1	1	1	X	1
Calcium Phosphate Acid	E0540-80	3	3	1	3	1	1	X	1	1	4	4	1	1	1	1	1	1	2
Calcium Propionate	E0540-80	3	3	1	3	1	1	X	1	1	4	4	1	1	1	1	1	1	2
Calcium Pyridine Sulfonate	V3819-75	X	X	X	X	1	1	X	X	X	X	X	X	X	X	X	X	X	X
Calcium Salts	N0674-70	1	1	1	1	1	1	1	1	1	1	1	1	1	1	1	1	1	2
Calcium Silicate	N0674-70	1	1	1	1	1	1	1	1	1	X	X	1	1	1	1	1	X	X
Calcium Stearate	V1164-75	2	2	4	1	1	1	X	4	4	4	3	4	4	4	4	4	2	X
Calcium Sulfamate	V1164-75	2	2	4	1	1	1	X	4	4	4	3	4	4	4	4	4	2	X
Calcium Sulfate	E0540-80	3	3	1	3	1	1	X	1	1	4	4	1	1	1	1	1	1	2
Calcium Sulfide	N0674-70	1	1	1	1	1	1	1	2	4	1	1	2	2	2	2	1	1	1
Calcium Sulfite	N0674-70	1	1	1	1	1	1	1	2	4	1	1	2	2	2	1	1	1	1
Calcium Thiocyanate	E0540-80	3	3	1	3	1	1	X	1	1	4	4	1	1	1	1	1	1	2
Calcium Thiosulfate	E0540-80	2	2	1	1	1	1	1	2	4	1	1	2	2	2	1	1	1	1
Calcium Tungstate	E0540-80	3	3	1	3	1	1	X	1	1	4	4	1	1	1	1	1	1	2
Caliche Liquors	N0674-70	1	1	1	1	1	1	1	1	1	1	1	1	1	1	1	1	1	2
Camphene	V1164-75	2	2	4	1	1	1	X	4	4	4	3	4	4	4	4	4	2	X
Camphor	V1164-75	2	2	4	1	1	1	X	4	4	4	3	4	4	4	4	4	2	X

Approximate Service Temperature Ranges for Commonly Used Basic Polymer Types*

Nitrile (General Service)	-34°C to 121°C (-30°F to 250°F)*	AFLAS	-9°C to 232°C (15°F to 450°F)*
Nitrile (Low Temperature)	-55°C to 107°C (-65°F to 225°F)*	Neoprene	-51°C to 107°C (-60°F to 225°F)*
Hydrogenated Nitrile	-32°C to 149°C (-23°F to 300°F)*	Polyacrylate	-21°C to 177°C (-5°F to 350°F)*
Ethylene Propylene	-57°C to 121°C (-70°F to 250°F)*	Polyurethane	-40°C to 82°C (-40°F to 180°F)*
Fluorocarbon	-26°C to 205°C (-15°F to 400°F)*	Butyl	-59°C to 120°C (-75°F to 250°F)*
Hifluor	-26°C to 205°C (-15°F to 400°F)*	Fluorosilicone	-73°C to 177°C (-100°F to 350°F)*
Perfluoroelastomer (Parofluor)	-26°C to 320°C (-15°F to 608°F)*	Silicone	-115°C to 232°C (-175°F to 450°F)*

NOTE: *These temperature ranges will apply to the majority of media for which the material is potentially recommended. With some media however, the service temperature range may be significantly different. ALWAYS TEST UNDER ACTUAL SERVICE CONDITIONS.

WARNING: These products can expose you to chemicals including carbon black (airborne and extracts), antimony trioxide, titanium dioxide, silica (crystalline), di(2-ethylhexyl) phthalate, ethylene thiourea, acrylonitrile, 1,3-butadiene, epichlorohydrin, toluenediisocyanate, tetrafluoroethylene, ethylbenzene, formaldehyde, furfuryl alcohol, glass fibers, methyl isobutyl ketone, nickel (metallic and compounds), lead and lead compounds which are known to the State of California to cause cancer; and 1,3-butadiene, epichlorohydrin, di(2-ethylhexyl)phthalate, di-isodecyl phthalate, ethylene thiourea, methyl isobutyl ketone, methanol, toluene, lead and lead compounds which are known to the State of California to cause birth defects and other reproductive harm. For more information go to www.P65Warnings.ca.gov.

COMPOUND COMPATIBILITY RATING
 1 - Satisfactory
 2 - Fair (usually OK for static seal)
 3 - Doubtful (sometimes OK for static seal)
 4 - Unsatisfactory
 x - Insufficient Data

	Recommended	Nitrile NBR	Hydrogenated Nitrile HNBR	Ethylene Propylene EPDM	Fluorocarbon FKM	Hifluor FKM	Perfluoroelastomer FFKM	Aflas (TFE/Propylene) FFKM	Neoprene/Chloroprene CR	Styrene-Butadiene SBR	Polyacrylate ACM	Polyurethane AU, EU	Butyl IIR	Butadiene BR	Isoprene IR	Natural Rubber NR	Hypalon CSM	Fluorosilicone FVMQ	Silicone MQ, VMQ, PVMQ
Camphoric Acid	V1164-75	2	2	4	1	1	1	X	4	4	4	3	4	4	4	4	4	2	X
Cane Sugar Liquors	N0674-70	1	1	1	1	1	1	1	1	1	4	4	1	1	1	1	1	1	1
Capric Acid	N0674-70	1	1	4	1	1	1	X	2	4	1	1	4	4	4	4	2	1	2
Caproic Acid	N0674-70	1	1	4	1	1	1	X	2	4	1	1	4	4	4	4	2	1	2
Caproic Aldehyde	E0540-80	X	X	2	4	1	1	3	X	X	4	4	2	2	2	2	X	4	2
Caprolactam	N0674-70	1	1	4	1	1	1	X	2	4	1	1	4	4	4	4	2	1	2
Capronaldehyde	N0674-70	1	1	4	1	1	1	X	2	4	1	1	4	4	4	4	2	1	2
Carbamate	V1164-75	3	3	2	1	1	1	2	4	4	4	2	4	4	4	4	2	1	X
Carbazole	V3819-75	X	X	X	X	1	1	X	X	X	X	X	X	X	X	X	X	X	X
Carbitol	E0540-80	2	2	2	2	1	1	2	2	4	4	2	2	2	2	2	2	2	2
Carbolic Acid (Phenol)	V0494-70	4	4	2	1	1	1	1	4	4	4	3	2	4	4	4	4	1	4
Carbon Bisulfide	V1164-75	4	4	4	1	1	1	2	4	4	3	X	4	4	4	4	4	1	4
Carbon Dioxide	N0674-70	1	1	1	1	1	1	1	1	1	1	1	1	1	1	1	1	1	1
Carbon Dioxide (Explosive Decompression Use)	E0962-90	1	1	1	1	1	1	1	1	1	1	1	1	1	1	1	1	1	1
Carbon Disulfide	V1164-75	4	4	4	1	1	1	2	4	4	3	X	4	4	4	4	4	1	4
Carbon Fluorides	V1164-75	2	2	4	1	1	1	2	4	4	4	4	4	4	4	4	4	2	4
Carbon Monoxide	N0674-70	1	1	1	1	1	1	2	2	X	1	1	2	2	2	2	2	2	1
Carbon Tetrabromide	V1164-75	X	X	X	X	1	1	X	X	X	X	X	X	X	X	X	X	X	X
Carbon Tetrachloride	V1164-75	2	2	4	1	1	1	2	4	4	4	4	4	4	4	4	4	2	4
Carbon Tetrafluoride	V1164-75	2	2	4	1	1	1	2	4	4	4	4	4	4	4	4	4	2	4
Carbonic Acid	E0540-80	2	2	1	1	1	1	1	2	1	1	1	2	1	1	1	1	1	1
Casein	E0540-80	3	3	1	3	1	1	X	1	1	4	4	1	1	1	1	1	1	2
Castor Oil	N0674-70	1	1	2	1	1	1	1	1	1	1	2	1	1	1	1	1	1	1
Caustic Lime	E0540-80	3	3	1	3	1	1	X	1	1	4	4	1	1	1	1	1	1	2
Caustic Potash	E0540-80	3	3	1	3	1	1	X	1	1	4	4	1	1	1	1	1	1	2
Caustic Soda (Sodium Hydroxide)	E0540-80	3	3	1	3	1	1	X	1	1	4	4	1	1	1	1	1	1	2
Cellosolve	E0540-80	4	4	2	4	1	1	3	4	4	4	4	2	4	4	4	4	4	4
Cellosolve, Acetate	E0540-80	4	4	2	4	1	1	2	4	4	4	4	2	4	4	4	4	4	4
Cellosolve, Butyl	E0540-80	4	4	2	4	1	1	2	4	4	4	4	2	4	4	4	4	4	4
Cellugard	N0674-70	1	1	1	1	1	1	1	1	3	4	1	1	1	1	1	1	1	1
Cellulose Acetate	E0540-80	3	3	1	3	2	1	X	1	1	4	4	1	1	1	1	1	1	2
Cellulose Acetate Butyrate	E0540-80	3	3	1	3	1	1	X	1	1	4	4	1	1	1	1	1	1	2
Cellulose Ether	E0540-80	3	3	1	3	2	1	X	1	1	4	4	1	1	1	1	1	1	2
Cellulose Nitrate*	E0540-80	3	3	1	3	1	1	X	1	1	4	4	1	1	1	1	1	1	2
Cellulose Tripropionate	E0540-80	3	3	1	3	1	1	X	1	1	4	4	1	1	1	1	1	1	2
Cellulube (Phosphate Esters)	V3819-75	X	X	X	X	1	1	X	X	X	X	X	X	X	X	X	X	X	X
Cellutherm 2505A	V1164-75	2	2	4	1	1	1	2	4	4	2	4	4	4	4	4	4	2	4
Cerium Sulfate	E0540-80	3	3	1	3	1	1	X	1	1	4	4	1	1	1	1	1	1	2
Cerous Chloride	E0540-80	3	3	1	3	1	1	X	1	1	4	4	1	1	1	1	1	1	2
Cerous Fluoride	E0540-80	3	3	1	3	1	1	X	1	1	4	4	1	1	1	1	1	1	2

Approximate Service Temperature Ranges for Commonly Used Basic Polymer Types*

Nitrile (General Service)	-34°C to 121°C (-30°F to 250°F)*	AFLAS	-9°C to 232°C (15°F to 450°F)*
Nitrile (Low Temperature)	-55°C to 107°C (-65°F to 225°F)*	Neoprene	-51°C to 107°C (-60°F to 225°F)*
Hydrogenated Nitrile	-32°C to 149°C (-23°F to 300°F)*	Polyacrylate	-21°C to 177°C (-5°F to 350°F)*
Ethylene Propylene	-57°C to 121°C (-70°F to 250°F)*	Polyurethane	-40°C to 82°C (-40°F to 180°F)*
Fluorocarbon	-26°C to 205°C (-15°F to 400°F)*	Butyl	-59°C to 120°C (-75°F to 250°F)*
Hifluor	-26°C to 205°C (-15°F to 400°F)*	Fluorosilicone	-73°C to 177°C (-100°F to 350°F)*
Perfluoroelastomer (Parofluor)	-26°C to 320°C (-15°F to 608°F)*	Silicone	-115°C to 232°C (-175°F to 450°F)*

NOTE: *These temperature ranges will apply to the majority of media for which the material is potentially recommended. With some media however, the service temperature range may be significantly different. ALWAYS TEST UNDER ACTUAL SERVICE CONDITIONS.

WARNING: These products can expose you to chemicals including carbon black (airborne and extracts), antimony trioxide, titanium dioxide, silica (crystalline), di(2-ethylhexyl) phthalate, ethylene thiourea, acrylonitrile, 1,3-butadiene, epichlorohydrin, toluenediisocyanate, tetrafluoroethylene, ethylbenzene, formaldehyde, furfuryl alcohol, glass fibers, methyl isobutyl ketone, nickel (metallic and compounds), lead and lead compounds which are known to the State of California to cause cancer; and 1,3-butadiene, epichlorohydrin, di(2-ethylhexyl)phthalate, di-isodecyl phthalate, ethylene thiourea, methyl isobutyl ketone, methanol, toluene, lead and lead compounds which are known to the State of California to cause birth defects and other reproductive harm. For more information go to www.P65Warnings.ca.gov.

Compatibility Tables for Gases, Fluids, Solids

COMPOUND COMPATIBILITY RATING
 1 - Satisfactory
 2 - Fair (usually OK for static seal)
 3 - Doubtful (sometimes OK for static seal)
 4 - Unsatisfactory
 x - Insufficient Data

	Recommended	Nitrile NBR	Hydrogenated Nitrile HNBR	Ethylene Propylene EPDM	Fluorocarbon FKM	Hifluor FKM	Perfluoroelastomer FFKM	Aflas (TFE/Propylene) FEPDM	Neoprene/Chloroprene CR	Styrene-Butadiene SBR	Polyacrylate ACM	Polyurethane AU, EU	Butyl IIR	Butadiene BR	Isoprene IR	Natural Rubber NR	Hypalon CSM	Fluorosilicone FVMQ	Silicone MQ, VMQ, PVMQ
Cerous Nitrate	E0540-80	3	3	1	3	1	1	X	1	1	4	4	1	1	1	1	1	1	2
Cesium Formate	E0962-90	X	X	2	4	1	1	X	X	X	X	X	X	X	X	X	X	X	X
Cetane (Hexadecane)	N0674-70	1	1	4	1	1	1	2	2	4	1	4	4	4	4	4	2	3	4
Cetyl Alcohol	N0674-70	1	1	4	1	1	1	X	2	4	1	1	4	4	4	4	2	1	2
Chaulmoogric Acid	V3819-75	X	X	X	X	1	1	X	X	X	X	X	X	X	X	X	X	X	X
China Wood Oil (Tung Oil)	N0674-70	1	1	4	1	1	1	2	2	4	X	3	3	4	4	4	3	2	4
Chloral	E0540-80	3	3	1	3	1	1	X	1	1	4	4	1	1	1	1	1	1	2
Chloramine	E1257-70	X	X	X	X	1	1	X	X	X	X	X	X	X	X	X	X	X	X
Chloranthraquinone	V1164-75	2	2	4	1	2	1	X	4	4	4	3	4	4	4	4	4	2	X
Chlorodane	V1164-75	2	2	4	1	1	1	2	3	4	X	X	4	4	4	4	3	2	4
Chlorextol	V1164-75	2	2	4	1	1	1	2	2	4	2	4	4	4	4	4	4	2	4
Chloric Acid	E0540-80	3	3	1	3	1	1	X	1	1	4	4	1	1	1	1	1	1	2
Chlorinated Solvents, Dry	V1164-75	4	4	4	1	1	1	2	4	4	4	4	4	4	4	4	4	1	4
Chlorinated Solvents, Wet	V1164-75	4	4	4	1	1	1	2	4	4	4	4	4	4	4	4	4	1	4
Chlorine (Dry)	V1164-75	2	2	4	1	1	1	X	4	4	4	3	4	4	4	4	4	2	X
Chlorine (Plasma)	V3819-75	X	X	X	X	3	2	X	X	X	X	X	X	X	X	X	X	X	X
Chlorine (Wet)	V3819-75	X	X	X	X	2	2	X	X	X	X	X	X	X	X	X	X	X	X
Chlorine Dioxide	V1164-75	4	4	3	1	1	1	2	4	4	4	4	3	4	4	4	3	2	X
Chlorine Dioxide, 8% Cl as NaClO2 in solution	V1164-75	4	4	4	1	1	1	2	4	4	4	4	4	4	4	4	4	2	X
Chlorine Trifluoride	Factory	4	4	4	4	2	2	4	4	4	4	4	4	4	4	4	4	4	4
Chlorine Water (Chemical Processing)	V1164-75	3	3	2	1	1	1	1	4	X	X	X	X	X	X	X	X	X	X
Chloro 1-Nitro Ethane (1-Chloro 1-Nitro Ethane)	Factory	4	4	4	4	1	1	3	4	4	4	4	4	4	4	4	4	4	4
Chloro Oxyfluorides	V3819-75	X	X	X	X	2	2	X	X	X	X	X	X	X	X	X	X	X	X
Chloro Xylenols	V1164-75	2	2	4	1	1	1	X	4	4	4	3	4	4	4	4	4	2	X
Chloroacetaldehyde	E0540-80	3	3	1	3	2	2	X	1	1	4	4	1	1	1	1	1	1	2
Chloroacetic Acid	E0540-80	4	4	2	4	1	1	2	4	4	4	4	2	4	4	4	1	4	X
Chloroacetone	E0540-80	4	4	1	4	2	1	2	4	4	4	4	2	4	4	4	4	4	4
Chloroacetyl Chloride	V3819-75	X	X	X	X	1	1	X	X	X	X	X	X	X	X	X	X	X	X
Chloroamino Benzoic Acid	E0540-80	3	3	1	3	1	1	X	1	1	4	4	1	1	1	1	1	1	2
Chloroaniline	E0540-80	3	3	1	3	1	1	X	1	1	4	4	1	1	1	1	1	1	2
Chlorobenzaldehyde	E0540-80	3	3	1	3	1	1	X	1	1	4	4	1	1	1	1	1	1	2
Chlorobenzene	V1164-75	4	4	4	1	1	1	2	4	4	4	4	4	4	4	4	4	2	4
Chlorobenzene (Mono)	V1164-75	4	4	4	1	1	1	2	4	4	4	4	4	4	4	4	4	2	4
Chlorobenzene Chloride	V1164-75	2	2	4	1	1	1	X	4	4	4	3	4	4	4	4	4	2	X
Chlorobenzene Trifluoride	V1164-75	2	2	4	1	1	1	X	4	4	4	3	4	4	4	4	4	2	X
Chlorobenzochloride	V1164-75	2	2	4	1	1	1	X	4	4	4	3	4	4	4	4	4	2	X
Chlorobenzotrifluoride	V1164-75	2	2	4	1	1	1	X	4	4	4	3	4	4	4	4	4	2	X
Chlorobromo Methane	V1164-75	4	4	2	1	1	1	1	4	4	4	4	2	4	4	4	4	2	4
Chlorobromopropane	V1164-75	2	2	4	1	1	1	X	4	4	4	3	4	4	4	4	4	2	X
Chlorobutadiene	V1164-75	4	4	4	1	1	1	2	4	4	4	4	4	4	4	4	4	2	4

Approximate Service Temperature Ranges for Commonly Used Basic Polymer Types*

Nitrile (General Service)	-34°C to 121°C (-30°F to 250°F)*	AFLAS	-9°C to 232°C (15°F to 450°F)*
Nitrile (Low Temperature)	-55°C to 107°C (-65°F to 225°F)*	Neoprene	-51°C to 107°C (-60°F to 225°F)*
Hydrogenated Nitrile	-32°C to 149°C (-23°F to 300°F)*	Polyacrylate	-21°C to 177°C (-5°F to 350°F)*
Ethylene Propylene	-57°C to 121°C (-70°F to 250°F)*	Polyurethane	-40°C to 82°C (-40°F to 180°F)*
Fluorocarbon	-26°C to 205°C (-15°F to 400°F)*	Butyl	-59°C to 120°C (-75°F to 250°F)*
Hifluor	-26°C to 205°C (-15°F to 400°F)*	Fluorosilicone	-73°C to 177°C (-100°F to 350°F)*
Perfluoroelastomer (Parofluor)	-26°C to 320°C (-15°F to 608°F)*	Silicone	-115°C to 232°C (-175°F to 450°F)*

NOTE: *These temperature ranges will apply to the majority of media for which the material is potentially recommended. With some media however, the service temperature range may be significantly different. ALWAYS TEST UNDER ACTUAL SERVICE CONDITIONS.

WARNING: These products can expose you to chemicals including carbon black (airborne and extracts), antimony trioxide, titanium dioxide, silica (crystalline), di(2-ethylhexyl) phthalate, ethylene thiourea, acrylonitrile, 1,3-butadiene, epichlorohydrin, toluenediisocyanate, tetrafluoroethylene, ethylbenzene, formaldehyde, furfuryl alcohol, glass fibers, methyl isobutyl ketone, nickel (metallic and compounds), lead and lead compounds which are known to the State of California to cause cancer; and 1,3-butadiene, epichlorohydrin, di(2-ethylhexyl)phthalate, di-isodecyl phthalate, ethylene thiourea, methyl isobutyl ketone, methanol, toluene, lead and lead compounds which are known to the State of California to cause birth defects and other reproductive harm. For more information go to www.P65Warnings.ca.gov.

COMPOUND COMPATIBILITY RATING
 1 - Satisfactory
 2 - Fair (usually OK for static seal)
 3 - Doubtful (sometimes OK for static seal)
 4 - Unsatisfactory
 x - Insufficient Data

	Recommended	Nitrile NBR	Hydrogenated Nitrile HNBR	Ethylene Propylene EPDM	Fluorocarbon FKM	Hifluor FKM	Perfluoroelastomer FFKM	Aflas (TFE/Propylene) FEPDM	Neoprene/Chloroprene CR	Styrene-Butadiene SBR	Polyacrylate ACM	Polyurethane AU, EU	Butyl IIR	Butadiene BR	Isoprene IR	Natural Rubber NR	Hypalon CSM	Fluorosilicone FVMQ	Silicone MQ, VMQ, PVMQ
Chlorobutane (Butyl Chloride)	N0674-70	1	1	4	1	1	1	X	2	4	1	1	4	4	4	4	2	1	2
Chlorododecane	V1164-75	4	4	4	1	1	1	2	4	4	4	4	4	4	4	4	4	1	4
Chloroethane	N0674-70	1	1	4	1	1	1	X	2	4	1	1	4	4	4	4	2	1	2
Chloroethane Sulfonic Acid	E0540-80	3	3	1	3	1	1	X	1	1	4	4	1	1	1	1	1	1	2
Chloroethylbenzene	V1164-75	2	2	4	1	1	1	X	4	4	4	3	4	4	4	4	4	2	X
Chloroform	V1164-75	4	4	4	1	1	1	2	4	4	4	4	4	4	4	4	4	4	4
Chlorohydrin	E0540-80	3	3	1	3	1	1	X	1	1	4	4	1	1	1	1	1	1	2
Chloronaphthalene or o-Chloronaphthalene	V1164-75	4	4	4	1	1	1	X	4	4	4	4	4	4	4	4	4	2	4
Chloronitrobenzene	E0540-80	3	3	1	3	1	1	X	1	1	4	4	1	1	1	1	1	1	2
Chlorophenol or o-Chlorophenol	V1164-75	4	4	4	1	1	1	X	4	4	4	4	4	4	4	4	4	2	4
Chloropicrin	V1164-75	2	2	4	1	1	1	X	4	4	4	3	4	4	4	4	4	2	X
Chloroprene	V1164-75	2	2	4	1	1	1	X	4	4	4	3	4	4	4	4	4	2	X
Chlorosilanes	V3819-75	X	X	X	X	1	1	X	X	X	X	X	X	X	X	X	X	X	X
Chlorosulfonic Acid	Factory	4	4	4	4	1	1	4	4	4	4	4	4	4	4	4	4	4	4
Chlorotoluene	V1164-75	4	4	4	1	1	1	2	4	4	4	4	4	4	4	4	4	2	4
Chlorotoluene Sulfonic Acid	E0540-80	3	3	1	3	1	1	X	1	1	4	4	1	1	1	1	1	1	2
Chlorotoluidine	V1164-75	2	2	4	1	1	1	X	4	4	4	3	4	4	4	4	4	2	X
Chlorotrifluoroethylene (CTFE)	V3819-75	X	X	X	X	2	2	X	X	X	X	X	X	X	X	X	X	X	X
Chlorox	E0540-80	2	2	1	1	1	1	2	4	4	4	2	4	4	4	4	2	1	X
Chloroxyols	V3819-75	X	X	X	X	1	1	X	X	X	X	X	X	X	X	X	X	X	X
Cholesterol	V1164-75	2	2	4	1	1	1	X	4	4	4	3	4	4	4	4	4	2	X
Chrome Alum	N0674-70	1	1	1	1	1	1	1	1	4	X	1	1	1	1	1	1	X	1
Chrome Plating Solutions	V1164-75	4	4	2	1	1	1	4	4	4	4	2	4	4	4	4	4	2	2
Chromic Acid	V1164-75	4	4	2	1	1	1	X	4	4	4	3	4	4	4	4	4	2	X
Chromic Chloride	V3819-75	X	X	X	X	1	1	X	X	X	X	X	X	X	X	X	X	X	X
Chromic Fluorides	V3819-75	X	X	X	X	1	1	X	X	X	X	X	X	X	X	X	X	X	X
Chromic Hydroxide	V3819-75	X	X	X	X	1	1	X	X	X	X	X	X	X	X	X	X	X	X
Chromic Nitrates	V3819-75	X	X	X	X	1	1	X	X	X	X	X	X	X	X	X	X	X	X
Chromic Oxide	V1164-75	4	4	2	1	1	1	4	X	X	X	X	X	X	X	X	X	X	X
Chromic Phosphate	V3819-75	X	X	X	X	1	1	X	X	X	X	X	X	X	X	X	X	X	X
Chromic Sulfate	V3819-75	X	X	X	X	1	1	X	X	X	X	X	X	X	X	X	X	X	X
Chromium Potassium Sulfate (Alum)	V1164-75	2	X	2	1	1	1	2	X	X	X	X	X	X	X	X	X	X	X
Chromyl Chlorides	V3819-75	X	X	X	X	1	1	X	X	X	X	X	X	X	X	X	X	X	X
Cinnamic Acid	V1164-75	2	2	4	1	1	1	X	4	4	4	3	4	4	4	4	4	2	X
Cinnamic Alcohol	V1164-75	2	2	4	1	1	1	X	4	4	4	3	4	4	4	4	4	2	X
Cinnamic Aldehyde	V1164-75	2	2	4	1	1	1	X	4	4	4	3	4	4	4	4	4	2	X
Circo Light Process Oil	N0674-70	1	1	4	1	1	1	2	2	4	1	1	4	4	4	4	2	1	4
Citric Acid	C0873-70	1	1	1	1	1	1	1	1	1	X	1	1	1	1	1	1	1	1
City Service #65 #120 #250	N0674-70	1	1	4	1	1	1	2	2	4	1	2	4	4	4	4	4	1	4
City Service Koolmoter-AP Gear Oil 140-EP Lube	N0674-70	1	1	4	1	1	1	2	2	4	1	1	4	4	4	4	2	1	4

Approximate Service Temperature Ranges for Commonly Used Basic Polymer Types*

Nitrile (General Service)	-34°C to 121°C (-30°F to 250°F)*	AFLAS	-9°C to 232°C (15°F to 450°F)*
Nitrile (Low Temperature)	-55°C to 107°C (-65°F to 225°F)*	Neoprene	-51°C to 107°C (-60°F to 225°F)*
Hydrogenated Nitrile	-32°C to 149°C (-23°F to 300°F)*	Polyacrylate	-21°C to 177°C (-5°F to 350°F)*
Ethylene Propylene	-57°C to 121°C (-70°F to 250°F)*	Polyurethane	-40°C to 82°C (-40°F to 180°F)*
Fluorocarbon	-26°C to 205°C (-15°F to 400°F)*	Butyl	-59°C to 120°C (-75°F to 250°F)*
Hifluor	-26°C to 205°C (-15°F to 400°F)*	Fluorosilicone	-73°C to 177°C (-100°F to 350°F)*
Perfluoroelastomer (Parofluor)	-26°C to 320°C (-15°F to 608°F)*	Silicone	-115°C to 232°C (-175°F to 450°F)*

NOTE: *These temperature ranges will apply to the majority of media for which the material is potentially recommended. With some media however, the service temperature range may be significantly different. ALWAYS TEST UNDER ACTUAL SERVICE CONDITIONS.

WARNING: These products can expose you to chemicals including carbon black (airborne and extracts), antimony trioxide, titanium dioxide, silica (crystalline), di(2-ethylhexyl) phthalate, ethylene thiourea, acrylonitrile, 1,3-butadiene, epichlorohydrin, toluenediisocyanate, tetrafluoroethylene, ethylbenzene, formaldehyde, furfuryl alcohol, glass fibers, methyl isobutyl ketone, nickel (metallic and compounds), lead and lead compounds which are known to the State of California to cause cancer; and 1,3-butadiene, epichlorohydrin, di(2-ethylhexyl)phthalate, di-isodecyl phthalate, ethylene thiourea, methyl isobutyl ketone, methanol, toluene, lead and lead compounds which are known to the State of California to cause birth defects and other reproductive harm. For more information go to www.P65Warnings.ca.gov.

Compatibility Tables for Gases, Fluids, Solids

COMPOUND COMPATIBILITY RATING
 1 - Satisfactory
 2 - Fair (usually OK for static seal)
 3 - Doubtful (sometimes OK for static seal)
 4 - Unsatisfactory
 x - Insufficient Data

	Recommended	Nitrile NBR	Hydrogenated Nitrile HNBR	Ethylene Propylene EPDM	Fluorocarbon FKM	Hifluor FKM	Perfluoroelastomer FFKM	Aflas (TFE/Propylene) FEPDM	Neoprene/Chloroprene CR	Styrene-Butadiene SBR	Polyacrylate ACM	Polyurethane AU, EU	Butyl IIR	Butadiene BR	Isoprene IR	Natural Rubber NR	Hypalon CSM	Fluorosilicone FVMQ	Silicone MQ, VMQ, PVMQ
City Service Pacemaker #2	N0674-70	1	1	4	1	1	1	2	2	4	1	2	4	4	4	4	4	1	4
Clorox	E0540-80	2	2	1	1	1	1	X	X	X	X	X	X	X	X	X	X	X	X
Coal Tar	N0674-70	1	X	X	1	1	1	X	X	X	X	X	X	X	X	X	X	X	X
Cobalt Chloride	N0674-70	1	1	1	1	1	1	1	1	1	1	1	1	1	1	1	1	1	2
Cobalt Chloride, 2N	N0674-70	1	1	1	1	1	1	1	1	1	4	4	1	1	1	1	1	1	1
Cobaltous Acetate	E0540-80	3	3	1	3	2	1	X	1	1	4	4	1	1	1	1	1	1	2
Cobaltous Bromide	N0674-70	1	1	1	1	1	1	1	1	1	4	4	1	1	1	1	1	1	1
Cobaltous Linoleate	V3819-75	X	X	X	X	1	1	X	X	X	X	X	X	X	X	X	X	X	X
Cobaltous Naphthenate	V3819-75	X	X	X	X	1	1	X	X	X	X	X	X	X	X	X	X	X	X
Cobaltous Sulfate	E0540-80	3	3	1	3	1	1	X	1	1	4	4	1	1	1	1	1	1	2
Coconut Oil	N0674-70	1	1	3	1	1	1	2	3	4	1	3	3	4	4	4	3	1	1
Cod Liver Oil	N0674-70	1	1	1	1	1	1	1	2	4	1	1	1	4	4	4	2	1	2
Codeine	V1164-75	2	2	4	1	1	1	X	4	4	4	3	4	4	4	4	4	2	X
Coffee	N0508-75	1	1	1	1	1	1	1	1	1	4	4	1	1	1	1	1	1	1
Coke Oven Gas	V1164-75	4	4	4	1	1	1	2	4	4	4	4	4	4	4	4	4	2	2
Coliche Liquors	C0873-70	2	2	2	X	X	X	2	1	2	X	X	2	1	1	1	X	X	X
Convelex 10	Factory	4	4	X	X	X	X	X	4	4	X	2	4	4	4	4	4	X	4
Coolanol 20 25R 35R 40& 45A (Monsanto)	V1164-75	1	1	3	1	1	1	2	2	4	4	1	4	4	4	4	2	1	4
Copper Acetate	E0540-80	2	2	1	4	1	1	2	2	4	4	4	1	4	1	1	2	4	4
Copper Ammonium Acetate	E0540-80	3	3	1	3	1	1	X	1	1	4	4	1	1	1	1	1	1	2
Copper Carbonate	E0540-80	3	3	1	3	1	1	X	1	1	4	4	1	1	1	1	1	1	2
Copper Chloride	N0674-70	1	1	1	1	1	1	1	2	1	1	1	1	1	1	1	2	1	1
Copper Cyanide	N0674-70	1	1	1	1	1	1	1	1	1	1	1	1	1	1	1	1	1	1
Copper Gluconate	E0540-80	3	3	1	3	1	1	X	1	1	4	4	1	1	1	1	1	1	2
Copper Naphthenate	V3819-75	X	X	X	X	1	1	X	X	X	X	X	X	X	X	X	X	X	X
Copper Nitrate	V1164-75	2	X	2	1	1	1	2	X	X	X	X	X	X	X	X	X	X	X
Copper Oxide	N0674-70	1	1	1	1	1	1	1	1	1	1	1	1	1	1	1	1	1	1
Copper Salts	N0674-70	1	1	1	1	1	1	1	1	1	1	1	1	1	1	1	1	1	1
Copper Sulfate	N0674-70	1	1	1	1	1	1	1	2	4	1	2	2	2	2	2	1	1	1
Copper Sulfate 10%	N0674-70	1	1	1	1	1	1	1	2	4	2	2	2	2	2	2	1	1	1
Copper Sulfate 50%	N0674-70	1	1	1	1	1	1	1	2	4	3	2	2	2	2	1	1	1	1
Corn Oil	N0674-70	1	1	3	1	1	1	2	3	4	1	1	3	4	4	4	2	1	1
Cottonseed Oil	N0674-70	1	1	3	1	1	1	2	3	4	1	1	3	4	4	4	2	1	1
Creosote, Coal Tar	N0674-70	1	1	4	1	1	1	2	2	4	1	3	4	4	4	4	4	1	4
Creosote, Wood	N0674-70	1	1	4	1	1	1	2	2	4	1	3	4	4	4	4	4	1	4
Cresol (Methyl Phenol)	V1164-75	X	X	X	1	1	1	X	X	X	X	X	X	X	X	X	X	X	X
Cresols	V0834-70	4	4	4	2	1	1	2	4	4	4	X	4	4	4	4	4	X	4
Cresylic Acid	V0834-70	4	4	4	1	1	1	2	4	4	4	4	4	4	4	4	4	X	4
Crotonaldehyde	V1164-75	2	2	4	1	1	1	X	4	4	4	3	4	4	4	4	4	2	X
Crotonic Acid	V1164-75	2	2	4	1	1	1	X	4	4	4	3	4	4	4	4	4	2	X

Approximate Service Temperature Ranges for Commonly Used Basic Polymer Types*

Nitrile (General Service)	-34°C to 121°C (-30°F to 250°F)*	AFLAS	-9°C to 232°C (15°F to 450°F)*
Nitrile (Low Temperature)	-55°C to 107°C (-65°F to 225°F)*	Neoprene	-51°C to 107°C (-60°F to 225°F)*
Hydrogenated Nitrile	-32°C to 149°C (-23°F to 300°F)*	Polyacrylate	-21°C to 177°C (-5°F to 350°F)*
Ethylene Propylene	-57°C to 121°C (-70°F to 250°F)*	Polyurethane	-40°C to 82°C (-40°F to 180°F)*
Fluorocarbon	-26°C to 205°C (-15°F to 400°F)*	Butyl	-59°C to 120°C (-75°F to 250°F)*
Hifluor	-26°C to 205°C (-15°F to 400°F)*	Fluorosilicone	-73°C to 177°C (-100°F to 350°F)*
Perfluoroelastomer (Parofluor)	-26°C to 320°C (-15°F to 608°F)*	Silicone	-115°C to 232°C (-175°F to 450°F)*

NOTE: *These temperature ranges will apply to the majority of media for which the material is potentially recommended. With some media however, the service temperature range may be significantly different. ALWAYS TEST UNDER ACTUAL SERVICE CONDITIONS.

WARNING: These products can expose you to chemicals including carbon black (airborne and extracts), antimony trioxide, titanium dioxide, silica (crystalline), di(2-ethylhexyl) phthalate, ethylene thiourea, acrylonitrile, 1,3-butadiene, epichlorohydrin, toluenediisocyanate, tetrafluoroethylene, ethylbenzene, formaldehyde, furfuryl alcohol, glass fibers, methyl isobutyl ketone, nickel (metallic and compounds), lead and lead compounds which are known to the State of California to cause cancer; and 1,3-butadiene, epichlorohydrin, di(2-ethylhexyl)phthalate, di-isodecyl phthalate, ethylene thiourea, methyl isobutyl ketone, methanol, toluene, lead and lead compounds which are known to the State of California to cause birth defects and other reproductive harm. For more information go to www.P65Warnings.ca.gov.

COMPOUND COMPATIBILITY RATING
 1 - Satisfactory
 2 - Fair (usually OK for static seal)
 3 - Doubtful (sometimes OK for static seal)
 4 - Unsatisfactory
 x - Insufficient Data

	Recommended	Nitrile NBR	Hydrogenated Nitrile HNBR	Ethylene Propylene EPDM	Fluorocarbon FKM	Hifluor FKM	Perfluoroelastomer FFKM	Aflas (TFE/Propylene) FFKM	Neoprene/Chloroprene CR	Styrene-Butadiene SBR	Polyacrylate ACM	Polyurethane AU, EU	Butyl IIR	Butadiene BR	Isoprene IR	Natural Rubber NR	Hypalon CSM	Fluorosilicone FVMQ	Silicone MQ, VMQ, PVMQ
Crude Oil	V1164-75	2	2	4	1	1	1	2	4	4	1	X	4	4	4	4	4	2	4
Cumaldehyde	V1164-75	2	2	4	1	1	1	X	4	4	4	3	4	4	4	4	4	2	X
Cumene	V1164-75	4	4	4	1	1	1	2	4	4	4	4	4	4	4	4	4	2	4
Cumene Hydroperoxide	V3819-75	X	X	X	X	1	1	X	X	X	X	X	X	X	X	X	X	X	X
Cupric Sulfate	V1164-75	2	X	2	1	1	1	2	X	X	X	X	X	X	X	X	X	X	X
Cutting Oil	N0674-70	1	1	4	1	1	1	2	2	4	1	1	4	4	4	4	2	1	4
Cyanamide	V3819-75	X	X	X	X	1	1	X	X	X	X	X	X	X	X	X	X	X	X
Cyanides	V3819-75	X	X	X	X	1	1	X	X	X	X	X	X	X	X	X	X	X	X
Cyanogen Chloride	V3819-75	X	X	X	X	1	1	X	X	X	X	X	X	X	X	X	X	X	X
Cyanogen Gas	V3819-75	X	X	X	X	1	1	X	X	X	X	X	X	X	X	X	X	X	X
Cyanohydrin	V3819-75	X	X	X	X	1	1	X	X	X	X	X	X	X	X	X	X	X	X
Cyanuric Chloride	V3819-75	X	X	X	X	1	1	X	X	X	X	X	X	X	X	X	X	X	X
Cyclohexane	N0674-70	1	1	4	1	1	1	2	3	4	2	1	4	4	4	4	4	1	4
Cyclohexanol	N0674-70	1	1	4	1	1	1	2	2	4	X	X	4	4	4	4	2	1	4
Cyclohexanone	E0540-80	4	4	2	4	1	1	3	4	4	4	4	2	4	4	4	4	4	4
Cyclohexene	V1164-75	2	2	4	1	1	1	X	4	4	4	3	4	4	4	4	4	2	X
Cyclohexylamine	N0674-70	1	1	4	1	1	1	X	2	4	1	1	4	4	4	4	2	1	2
Cyclohexylamine Carbonate	FF500-75	X	X	X	X	1	1	X	X	X	X	X	X	X	X	X	X	X	X
Cyclohexylamine Laurate	N0674-70	1	1	4	1	1	1	X	2	4	1	1	4	4	4	4	2	1	2
Cyclopentadiene	V1164-75	2	2	4	1	1	1	X	4	4	4	3	4	4	4	4	4	2	X
Cyclopentane	N0674-70	1	1	4	1	1	1	2	3	4	2	1	4	4	4	4	4	1	4
Cyclopolyolefins	V1164-75	1	1	4	1	1	1	2	3	4	2	1	4	4	4	4	4	1	4
Cymene or p-Cymene	V1164-75	4	4	4	1	1	1	X	4	4	4	4	4	4	4	4	4	2	4
- D -																			
DDT (Dichlorodiphenyltrichloroethane)	V1164-75	2	2	4	1	1	1	X	4	4	4	3	4	4	4	4	4	2	X
Decalin	V1164-75	4	4	4	1	1	1	2	4	4	X	X	4	4	4	4	4	1	4
Decane	N0674-70	1	1	4	1	1	1	2	3	4	1	2	4	4	4	4	3	1	2
Delco Brake Fluid	E0667-70	3	3	1	4	1	1	2	2	1	X	X	2	X	X	X	2	4	3
Denatured Alcohol	N0674-70	1	1	1	1	1	1	1	1	1	4	4	1	1	1	1	1	1	1
Detergent, Water Solution	E0540-80	1	1	1	1	1	1	2	2	4	4	1	2	2	2	2	1	1	1
Developing Fluids (Photo)	N0674-70	1	1	2	1	1	1	1	2	X	X	2	2	1	1	1	1	1	1
Dexron	N0674-70	1	1	4	1	1	1	2	2	4	1	2	4	4	4	4	4	2	4
Dextrin	N0674-70	1	1	4	1	1	1	X	2	4	1	1	4	4	4	4	2	1	2
Dextro Lactic Acid	E0540-80	3	3	1	3	1	1	X	1	1	4	4	1	1	1	1	1	1	2
Dextron	N0674-70	1	1	4	1	1	1	2	X	X	X	X	X	X	X	X	X	X	X
Dextrose	E0540-80	3	3	1	3	1	1	X	1	1	4	4	1	1	1	1	1	1	2
DF200	E0540-80	X	X	X	X	X	X	X	X	X	X	X	X	X	X	X	X	X	X
DI Water	E0540-80	2	X	1	2	1	1	X	1	1	4	4	1	1	1	1	1	1	2
Diacetone	E0540-80	4	4	1	4	1	1	2	4	4	4	4	1	4	4	4	4	4	4
Diacetone Alcohol	E0540-80	4	4	1	4	1	1	2	2	4	4	4	1	4	4	4	2	4	4

Approximate Service Temperature Ranges for Commonly Used Basic Polymer Types*

Nitrile (General Service)	-34°C to 121°C (-30°F to 250°F)*	AFLAS	-9°C to 232°C (15°F to 450°F)*
Nitrile (Low Temperature)	-55°C to 107°C (-65°F to 225°F)*	Neoprene	-51°C to 107°C (-60°F to 225°F)*
Hydrogenated Nitrile	-32°C to 149°C (-23°F to 300°F)*	Polyacrylate	-21°C to 177°C (-5°F to 350°F)*
Ethylene Propylene	-57°C to 121°C (-70°F to 250°F)*	Polyurethane	-40°C to 82°C (-40°F to 180°F)*
Fluorocarbon	-26°C to 205°C (-15°F to 400°F)*	Butyl	-59°C to 120°C (-75°F to 250°F)*
Hifluor	-26°C to 205°C (-15°F to 400°F)*	Fluorosilicone	-73°C to 177°C (-100°F to 350°F)*
Perfluoroelastomer (Parofluor)	-26°C to 320°C (-15°F to 608°F)*	Silicone	-115°C to 232°C (-175°F to 450°F)*

NOTE: *These temperature ranges will apply to the majority of media for which the material is potentially recommended. With some media however, the service temperature range may be significantly different. ALWAYS TEST UNDER ACTUAL SERVICE CONDITIONS.

WARNING: These products can expose you to chemicals including carbon black (airborne and extracts), antimony trioxide, titanium dioxide, silica (crystalline), di(2-ethylhexyl) phthalate, ethylene thiourea, acrylonitrile, 1,3-butadiene, epichlorohydrin, toluenediisocyanate, tetrafluoroethylene, ethylbenzene, formaldehyde, furfuryl alcohol, glass fibers, methyl isobutyl ketone, nickel (metallic and compounds), lead and lead compounds which are known to the State of California to cause cancer; and 1,3-butadiene, epichlorohydrin, di(2-ethylhexyl)phthalate, di-isodecyl phthalate, ethylene thiourea, methyl isobutyl ketone, methanol, toluene, lead and lead compounds which are known to the State of California to cause birth defects and other reproductive harm. For more information go to www.P65Warnings.ca.gov.

Compatibility Tables for Gases, Fluids, Solids

COMPOUND COMPATIBILITY RATING
 1 - Satisfactory
 2 - Fair (usually OK for static seal)
 3 - Doubtful (sometimes OK for static seal)
 4 - Unsatisfactory
 x - Insufficient Data

	Recommended	Nitrile NBR	Hydrogenated Nitrile HNBR	Ethylene Propylene EPDM	Fluorocarbon FKM	Hifluor FKM	Perfluoroelastomer FFKM	Aflas (TFE/Propylene) FEPDM	Neoprene/Chloroprene CR	Styrene-Butadiene SBR	Polyacrylate ACM	Polyurethane AU, EU	Butyl IIR	Butadiene BR	Isoprene IR	Natural Rubber NR	Hypalon CSM	Fluorosilicone FVMQ	Silicone MQ, VMQ, PVMQ
Dialkyl Sulfates	E0540-80	3	3	1	3	1	1	X	1	1	4	4	1	1	1	1	1	1	2
Diallyl Ether	V3819-75	X	X	X	X	1	1	X	X	X	X	X	X	X	X	X	X	X	X
Diallyl Phthalate	V3819-75	X	X	X	X	1	1	X	X	X	X	X	X	X	X	X	X	X	X
Diamylamine	N0674-70	1	1	4	1	2	1	X	2	4	1	1	4	4	4	4	2	1	2
Diazinon	V1164-75	3	3	4	2	1	1	2	3	4	X	X	4	4	4	4	3	2	4
Dibenzyl (sym-Diphenylethane)	V1164-75	2	2	4	1	1	1	X	4	4	4	3	4	4	4	4	4	2	X
Dibenzyl Ether	Factory	4	4	2	4	1	1	2	4	4	X	2	2	4	4	4	4	X	X
Dibenzyl Sebacate	V1164-75	4	4	2	2	1	1	2	4	4	4	2	2	4	4	4	4	3	3
Diborane	V3819-75	X	X	X	X	1	1	X	X	X	X	X	X	X	X	X	X	X	X
Dibromoethane	V1164-75	2	2	4	1	1	1	X	4	4	4	3	4	4	4	4	4	2	X
Dibromoethyl Benzene	V1164-75	4	4	4	1	1	1	2	4	4	4	4	4	4	4	4	4	2	4
Dibutyl Cellosolve Adipate	E0540-80	3	3	1	3	1	1	X	1	1	4	4	1	1	1	1	1	1	2
Dibutyl Ether	Factory	4	4	3	3	1	1	3	4	4	3	2	3	4	4	4	4	3	4
Dibutyl Methyleneidithio Glycolate	V1164-75	2	2	4	1	1	1	X	4	4	4	3	4	4	4	4	4	2	X
Dibutyl Phthalate	E0540-80	4	4	2	3	2	1	3	4	4	4	3	3	4	4	4	4	3	2
Dibutyl Sebacate	E0540-80	4	4	2	2	1	1	2	4	4	4	4	2	4	4	4	4	2	2
Dibutyl Thioglycolate	V1164-75	2	2	4	1	1	1	X	4	4	4	3	4	4	4	4	4	2	X
Dibutyl Thiourea	V1164-75	2	2	4	1	1	1	X	4	4	4	3	4	4	4	4	4	2	X
Dibutylamine	E0540-80	4	4	1	4	1	1	4	3	4	4	4	4	4	4	4	4	4	3
Dichloroacetic Acid	V1164-75	2	2	4	1	1	1	X	4	4	4	3	4	4	4	4	4	2	X
Dichloroaniline	E0540-80	3	3	1	3	1	1	X	1	1	4	4	1	1	1	1	1	1	2
Dichlorobenzene or o-Dichlorobenzene	V1164-75	4	4	4	1	1	1	X	4	4	4	4	4	4	4	4	4	2	4
Dichlorobenzene or p-Dichlorobenzene	V1164-75	4	4	4	1	1	1	X	4	4	4	4	4	4	4	4	4	2	4
Dichlorobutane	V1164-75	2	2	4	1	1	1	2	4	4	4	4	4	4	4	4	4	2	4
Dichlorobutene	V1164-75	2	2	4	1	1	1	X	4	4	4	3	4	4	4	4	4	2	X
Dichlorodiphenyl-Dichloroethane (DDD)	V1164-75	2	2	4	1	1	1	X	4	4	4	3	4	4	4	4	4	2	X
Dichloroethane	V1164-75	2	2	4	1	1	1	X	4	4	4	3	4	4	4	4	4	2	X
Dichloroethylene	V1164-75	2	2	4	1	1	1	X	4	4	4	3	4	4	4	4	4	2	X
Dichlorohydrin	E0540-80	3	3	1	3	1	1	X	1	1	4	4	1	1	1	1	1	1	2
Dichloroisopropyl Ether	Factory	4	4	3	3	1	1	3	4	4	3	2	4	4	4	4	4	3	4
Dichloromethane	V1164-75	2	2	4	1	1	1	X	4	4	4	3	4	4	4	4	4	2	X
Dichlorophenol	V1164-75	2	2	4	1	1	1	X	4	4	4	3	4	4	4	4	4	2	X
Dichlorophenoxyacetic Acid	V1164-75	2	2	4	1	1	1	X	4	4	4	3	4	4	4	4	4	2	X
Dichloropropane	V1164-75	2	2	4	1	1	1	X	4	4	4	3	4	4	4	4	4	2	X
Dichloropropene	V1164-75	2	2	4	1	1	1	X	4	4	4	3	4	4	4	4	4	2	X
Dichlorosilane	V3819-75	X	X	X	X	1	1	X	X	X	X	X	X	X	X	X	X	X	X
Dicyclohexylamine	N0674-70	1	1	4	4	1	1	4	4	4	4	4	4	4	4	4	4	4	2
Dicyclohexylammonium Nitrate	E0540-80	3	3	1	3	1	1	X	1	1	4	4	1	1	1	1	1	1	2
Dicyclopentadiene	V3819-75	X	X	X	X	1	1	X	X	X	X	X	X	X	X	X	X	X	X
Dieldrin	V1164-75	2	2	4	1	1	1	X	4	4	4	3	4	4	4	4	4	2	X

Approximate Service Temperature Ranges for Commonly Used Basic Polymer Types*

Nitrile (General Service)	-34°C to 121°C (-30°F to 250°F)*	AFLAS	-9°C to 232°C (15°F to 450°F)*
Nitrile (Low Temperature)	-55°C to 107°C (-65°F to 225°F)*	Neoprene	-51°C to 107°C (-60°F to 225°F)*
Hydrogenated Nitrile	-32°C to 149°C (-23°F to 300°F)*	Polyacrylate	-21°C to 177°C (-5°F to 350°F)*
Ethylene Propylene	-57°C to 121°C (-70°F to 250°F)*	Polyurethane	-40°C to 82°C (-40°F to 180°F)*
Fluorocarbon	-26°C to 205°C (-15°F to 400°F)*	Butyl	-59°C to 120°C (-75°F to 250°F)*
Hifluor	-26°C to 205°C (-15°F to 400°F)*	Fluorosilicone	-73°C to 177°C (-100°F to 350°F)*
Perfluoroelastomer (Parofluor)	-26°C to 320°C (-15°F to 608°F)*	Silicone	-115°C to 232°C (-175°F to 450°F)*

NOTE: *These temperature ranges will apply to the majority of media for which the material is potentially recommended. With some media however, the service temperature range may be significantly different. ALWAYS TEST UNDER ACTUAL SERVICE CONDITIONS.

⚠ WARNING: These products can expose you to chemicals including carbon black (airborne and extracts), antimony trioxide, titanium dioxide, silica (crystalline), di(2-ethylhexyl) phthalate, ethylene thiourea, acrylonitrile, 1,3-butadiene, epichlorohydrin, toluenediisocyanate, tetrafluoroethylene, ethylbenzene, formaldehyde, furfuryl alcohol, glass fibers, methyl isobutyl ketone, nickel (metallic and compounds), lead and lead compounds which are known to the State of California to cause cancer; and 1,3-butadiene, epichlorohydrin, di(2-ethylhexyl)phthalate, di-isodecyl phthalate, ethylene thiourea, methyl isobutyl ketone, methanol, toluene, lead and lead compounds which are known to the State of California to cause birth defects and other reproductive harm. For more information go to www.P65Warnings.ca.gov.

COMPOUND COMPATIBILITY RATING
 1 - Satisfactory
 2 - Fair (usually OK for static seal)
 3 - Doubtful (sometimes OK for static seal)
 4 - Unsatisfactory
 x - Insufficient Data

	Recommended	Nitrile NBR	Hydrogenated Nitrile HNBR	Ethylene Propylene EPDM	Fluorocarbon FKM	Hifluor FKM	Perfluoroelastomer FFKM	Aflas (TFE/Propylene) FFKM	Neoprene/Chloroprene CR	Styrene-Butadiene SBR	Polyacrylate ACM	Polyurethane AU, EU	Butyl IIR	Butadiene BR	Isoprene IR	Natural Rubber NR	Hypalon CSM	Fluorosilicone FVMQ	Silicone MQ, VMQ, PVMQ
Diesel Oil	N0674-70	1	1	4	1	1	1	2	3	4	1	3	4	4	4	4	3	1	4
Di-ester Lubricant MIL-L-7808	V1164-75	2	2	4	1	1	1	2	4	4	2	4	4	4	4	4	4	2	4
Di-ester Synthetic Lubricants	V1164-75	2	2	4	1	1	1	2	4	4	2	4	4	4	4	4	4	2	4
Diethanolamine (DEA)	E0540-80	3	3	1	3	2	1	X	1	1	4	4	1	1	1	1	1	1	2
Diethyl Benzene	V1164-75	X	X	X	1	1	1	X	X	X	X	X	X	X	X	X	X	X	X
Diethyl Carbonate	E0540-80	3	3	1	3	1	1	X	1	1	4	4	1	1	1	1	1	1	2
Diethyl Ether	Factory	4	4	4	4	1	1	4	3	4	3	1	4	4	4	4	4	3	4
Diethyl Phthalate	V1164-75	2	2	4	1	1	1	X	4	4	4	3	4	4	4	4	4	2	X
Diethyl Sebacate	V1164-75	2	2	2	2	1	1	2	4	4	4	4	2	4	4	4	4	2	2
Diethyl Sulfate	E0540-80	4	X	1	3	1	1	2	4	X	X	X	X	X	X	X	X	X	2
Diethylamine	E0540-80	2	X	1	4	1	1	X	1	1	4	4	1	1	1	1	1	1	2
Diethylaniline	E0540-80	3	3	1	3	1	1	X	1	1	4	4	1	1	1	1	1	1	2
Diethylene Glycol	E0540-80	1	1	1	1	1	1	1	1	1	2	4	1	1	1	1	1	1	2
Diethylene Glycol B	V3819-75	X	X	X	X	X	X	X	X	X	X	X	X	X	X	X	X	X	X
Diethylenetriamine	FF500-75	X	X	X	X	1	1	X	X	X	X	X	X	X	X	X	X	X	X
Difluorodibromomethane	E0540-80	4	4	2	X	1	1	2	4	4	4	4	2	4	4	4	4	X	4
Difluoroethane	V1164-75	2	2	4	1	1	1	X	4	4	4	3	4	4	4	4	4	2	X
Difluoromonochloroethane	V1164-75	2	2	4	1	1	1	X	4	4	4	3	4	4	4	4	4	2	X
Diglycol Chloroformate	E0540-80	3	3	1	3	1	1	X	1	1	4	4	1	1	1	1	1	1	2
Diglycolamine	C0873-70	X	X	X	X	X	X	X	X	X	X	X	X	X	X	X	X	X	X
Diglycolic Acid	E0540-80	3	3	1	3	1	1	X	1	1	4	4	1	1	1	1	1	1	2
Dihydroxydiphenylsulfone	E0540-80	3	3	1	3	2	1	X	1	1	4	4	1	1	1	1	1	1	2
Diisobutyl Ketone	E0540-80	X	X	1	X	2	1	1	X	X	X	X	1	X	X	X	X	X	X
Diisobutylcarbinol	N0674-70	1	1	4	1	1	1	X	2	4	1	1	4	4	4	4	2	1	2
Diisobutylene	V1164-75	2	2	4	1	1	1	2	4	4	4	4	4	4	4	4	4	3	4
Diisooctyl Sebacate	V1164-75	3	3	3	2	1	1	2	4	4	4	4	4	4	4	4	4	3	3
Diisopropyl Ether (DIPE)	V3819-75	X	X	X	X	2	1	X	X	X	X	X	X	X	X	X	X	X	X
Diisopropyl Ketone	E0540-80	4	4	1	4	2	1	2	4	4	4	4	1	4	4	4	4	4	4
Diisopropylbenzene	V1164-75	2	2	4	1	1	1	X	4	4	4	3	4	4	4	4	4	2	X
Diisopropylidene Acetone	V1164-75	2	2	4	1	1	1	X	4	4	4	3	4	4	4	4	4	2	X
Dimethoxyethane (DME)		X	X	X	X	X	X	X	X	X	X	X	X	X	X	X	X	X	X
Dimethyl Acetamide	E0540-80	3	3	1	3	1	1	X	1	1	4	4	1	1	1	1	1	4	2
Dimethylaniline (Xylidine)	V1164-75	2	2	4	1	1	1	X	4	4	4	3	4	4	4	4	4	2	X
Dimethyldisulfide (DMDS)	N0674-70	1	1	4	1	1	1	X	2	4	1	1	4	4	4	4	4	1	2
Dimethyl Ether	N0674-70	1	X	2	2	1	1	4	3	X	X	X	X	X	X	X	X	X	X
Dimethyl Formaldehyde	E0540-80	3	3	1	3	1	1	X	1	1	4	4	1	1	1	1	1	1	2
Dimethyl Formamide (DMF)	E0540-80	2	2	1	4	1	1	2	3	4	4	4	2	X	X	4	4	4	2
Dimethylhydrazine	E0540-80	3	3	1	3	1	1	X	1	1	4	4	1	1	1	1	1	1	2
Dimethyl Phenyl Carbinol	V1164-75	2	2	4	1	1	1	X	4	4	4	3	4	4	4	4	4	2	X
Dimethyl Phenyl Methanol	V1164-75	2	2	4	1	1	1	X	4	4	4	3	4	4	4	4	4	2	X

Approximate Service Temperature Ranges for Commonly Used Basic Polymer Types*

Nitrile (General Service)	-34°C to 121°C (-30°F to 250°F)*	AFLAS	-9°C to 232°C (15°F to 450°F)*
Nitrile (Low Temperature)	-55°C to 107°C (-65°F to 225°F)*	Neoprene	-51°C to 107°C (-60°F to 225°F)*
Hydrogenated Nitrile	-32°C to 149°C (-23°F to 300°F)*	Polyacrylate	-21°C to 177°C (-5°F to 350°F)*
Ethylene Propylene	-57°C to 121°C (-70°F to 250°F)*	Polyurethane	-40°C to 82°C (-40°F to 180°F)*
Fluorocarbon	-26°C to 205°C (-15°F to 400°F)*	Butyl	-59°C to 120°C (-75°F to 250°F)*
Hifluor	-26°C to 205°C (-15°F to 400°F)*	Fluorosilicone	-73°C to 177°C (-100°F to 350°F)*
Perfluoroelastomer (Parofluor)	-26°C to 320°C (-15°F to 608°F)*	Silicone	-115°C to 232°C (-175°F to 450°F)*

NOTE: *These temperature ranges will apply to the majority of media for which the material is potentially recommended. With some media however, the service temperature range may be significantly different. ALWAYS TEST UNDER ACTUAL SERVICE CONDITIONS.

WARNING: These products can expose you to chemicals including carbon black (airborne and extracts), antimony trioxide, titanium dioxide, silica (crystalline), di(2-ethylhexyl) phthalate, ethylene thiourea, acrylonitrile, 1,3-butadiene, epichlorohydrin, toluenediisocyanate, tetrafluoroethylene, ethylbenzene, formaldehyde, furfuryl alcohol, glass fibers, methyl isobutyl ketone, nickel (metallic and compounds), lead and lead compounds which are known to the State of California to cause cancer; and 1,3-butadiene, epichlorohydrin, di(2-ethylhexyl)phthalate, di-isodecyl phthalate, ethylene thiourea, methyl isobutyl ketone, methanol, toluene, lead and lead compounds which are known to the State of California to cause birth defects and other reproductive harm. For more information go to www.P65Warnings.ca.gov.

Compatibility Tables for Gases, Fluids, Solids

COMPOUND COMPATIBILITY RATING
1 - Satisfactory
2 - Fair (usually OK for static seal)
3 - Doubtful (sometimes OK for static seal)
4 - Unsatisfactory
x - Insufficient Data

	Recommended	Nitrile NBR	Hydrogenated Nitrile HNBR	Ethylene Propylene EPDM	Fluorocarbon FKM	Hifluor FKM	Perfluoroelastomer FFKM	Aflas (TFE/Propylene) FEPDM	Neoprene/Chloroprene CR	Styrene-Butadiene SBR	Polyacrylate ACM	Polyurethane AU, EU	Butyl IIR	Butadiene BR	Isoprene IR	Natural Rubber NR	Hypalon CSM	Fluorosilicone FVMQ	Silicone MQ, VMQ, PVMQ
Dimethyl Phthalate	V1164-75	4	4	2	2	1	1	2	4	4	4	X	2	4	4	4	4	2	X
Dimethyl Sulfoxide (DMSO)	E0540-80	3	3	1	3	1	1	X	1	1	4	4	1	1	1	1	1	1	2
Dimethyl Terephthalate (DMT)	V1164-75	2	2	4	1	1	1	X	4	4	4	3	4	4	4	4	4	2	X
Dimethylamine (DMA)	E0540-80	2	2	1	4	1	1	2	2	2	4	3	2	2	2	2	3	4	2
Dinitrochlorobenzene	V1164-75	2	2	4	1	1	1	X	4	4	4	3	4	4	4	4	4	2	X
Dinitrogen Tetroxide	FF500-75	X	X	X	X	2	2	X	X	X	X	X	X	X	X	X	X	X	X
Dinitrotoluene (DNT)	Factory	4	4	4	4	1	1	4	4	4	4	4	4	4	4	4	4	4	4
Diethyl Phthalate	V1164-75	4	4	2	2	1	1	2	4	4	4	4	2	4	4	4	4	2	3
Diethyl Sebacate	E0540-80	4	4	2	2	1	1	2	4	4	4	2	2	4	4	4	4	3	3
Diethylamine	N0674-70	1	1	4	1	1	1	X	2	4	1	1	4	4	4	4	2	1	2
Dioxane	E0540-80	4	4	2	4	1	1	3	4	4	4	4	2	4	4	4	4	4	4
Dioxolane	E0540-80	4	4	2	4	1	1	3	4	4	4	4	3	4	4	4	4	4	4
Dipentene	N0674-70	2	2	4	1	1	1	2	4	4	4	4	4	4	4	4	4	2	4
Diphenyl	V1164-75	4	4	4	1	1	1	2	4	4	4	4	4	4	4	4	4	2	4
Diphenyl Oxides	V1164-75	4	4	4	1	1	1	2	4	4	4	4	4	4	4	4	4	2	3
Diphenylamine (DPA)	V1164-75	2	2	4	1	1	1	X	4	4	4	3	4	4	4	4	4	2	X
Diphenylene Oxide	V3819-75	X	X	X	X	1	1	X	X	X	X	X	X	X	X	X	X	X	X
Diphenylpropane	V1164-75	2	2	4	1	1	1	X	4	4	4	3	4	4	4	4	4	2	X
Disilane	V3819-75	X	X	X	X	1	1	X	X	X	X	X	X	X	X	X	X	X	X
Di-Tert-Butyl Peroxide	V3819-75	X	X	X	X	1	1	X	X	X	X	X	X	X	X	X	X	X	X
D-Limonene		X	X	X	X	X	X	X	X	X	X	X	X	X	X	X	X	X	X
Dodecylbenzene	V1164-75	2	2	4	1	1	1	X	4	4	4	3	4	4	4	4	4	2	X
Dow Chemical 50-4	E0540-80	X	X	1	4	3	2	2	2	1	X	X	2	X	X	X	2	4	X
Dow Chemical ET378	Factory	4	4	X	X	X	X	X	4	4	3	2	4	4	4	4	4	X	4
Dow Chemical ET588	E0540-80	3	3	1	4	3	2	2	2	1	X	X	2	X	X	X	2	4	X
Dow Corning -11	E0540-80	2	2	1	1	1	1	1	1	1	1	1	1	1	1	1	1	1	2
Dow Corning 1208, 4050, 6620, F-60, XF-60	N0674-70	1	1	1	1	1	1	1	1	X	X	X	X	X	X	X	X	X	X
Dow Corning -1265 Fluorosilicone Fluid	E0540-80	2	2	1	1	1	1	1	1	1	1	1	1	1	1	1	1	3	1
Dow Corning -200	E0540-80	2	2	1	1	1	1	1	1	1	1	1	1	1	1	1	1	2	3
Dow Corning -220	N0674-70	1	1	1	1	1	1	1	1	X	X	X	X	X	X	X	X	X	X
Dow Corning -3	E0540-80	2	2	1	1	1	1	X	1	1	1	1	1	1	1	1	1	1	2
Dow Corning -33	E0540-80	2	2	1	1	1	1	X	1	1	1	1	1	1	1	1	1	2	3
Dow Corning -4	E0540-80	2	2	1	1	1	1	X	1	1	1	1	1	1	1	1	1	1	2
Dow Corning -44	E0540-80	2	2	1	1	1	1	X	1	1	1	1	1	1	1	1	1	2	3
Dow Corning -5	E0540-80	2	2	1	1	1	1	X	1	1	1	1	1	1	1	1	1	2	3
Dow Corning -510	E0540-80	2	2	1	1	1	1	X	1	1	1	1	1	1	1	1	1	2	3
Dow Corning -55	E0540-80	2	2	1	1	1	1	X	1	1	1	1	1	1	1	1	1	2	3
Dow Corning -550	E0540-80	2	2	1	1	1	1	X	1	1	1	1	1	1	1	1	1	2	3
Dow Corning -704	E0540-80	2	2	1	1	1	1	X	1	1	1	1	1	1	1	1	1	2	3
Dow Corning -705	E0540-80	2	2	1	1	1	1	X	1	1	1	1	1	1	1	1	1	2	3

Approximate Service Temperature Ranges for Commonly Used Basic Polymer Types*

Nitrile (General Service)	-34°C to 121°C (-30°F to 250°F)*	AFLAS	-9°C to 232°C (15°F to 450°F)*
Nitrile (Low Temperature)	-55°C to 107°C (-65°F to 225°F)*	Neoprene	-51°C to 107°C (-60°F to 225°F)*
Hydrogenated Nitrile	-32°C to 149°C (-23°F to 300°F)*	Polyacrylate	-21°C to 177°C (-5°F to 350°F)*
Ethylene Propylene	-57°C to 121°C (-70°F to 250°F)*	Polyurethane	-40°C to 82°C (-40°F to 180°F)*
Fluorocarbon	-26°C to 205°C (-15°F to 400°F)*	Butyl	-59°C to 120°C (-75°F to 250°F)*
Hifluor	-26°C to 205°C (-15°F to 400°F)*	Fluorosilicone	-73°C to 177°C (-100°F to 350°F)*
Perfluoroelastomer (Parofluor)	-26°C to 320°C (-15°F to 608°F)*	Silicone	-115°C to 232°C (-175°F to 450°F)*

NOTE: *These temperature ranges will apply to the majority of media for which the material is potentially recommended. With some media however, the service temperature range may be significantly different. ALWAYS TEST UNDER ACTUAL SERVICE CONDITIONS.



WARNING: These products can expose you to chemicals including carbon black (airborne and extracts), antimony trioxide, titanium dioxide, silica (crystalline), di(2-ethylhexyl) phthalate, ethylene thiourea, acrylonitrile, 1,3-butadiene, epichlorohydrin, toluenediisocyanate, tetrafluoroethylene, ethylbenzene, formaldehyde, furfuryl alcohol, glass fibers, methyl isobutyl ketone, nickel (metallic and compounds), lead and lead compounds which are known to the State of California to cause cancer; and 1,3-butadiene, epichlorohydrin, di(2-ethylhexyl)phthalate, di-isodecyl phthalate, ethylene thiourea, methyl isobutyl ketone, methanol, toluene, lead and lead compounds which are known to the State of California to cause birth defects and other reproductive harm. For more information go to www.P65Warnings.ca.gov.

COMPOUND COMPATIBILITY RATING
 1 - Satisfactory
 2 - Fair (usually OK for static seal)
 3 - Doubtful (sometimes OK for static seal)
 4 - Unsatisfactory
 x - Insufficient Data

	Recommended	Nitrile NBR	Hydrogenated Nitrile HNBR	Ethylene Propylene EPDM	Fluorocarbon FKM	Hifluor FKM	Perfluoroelastomer FFKM	Aflas (TFE/Propylene) FFKM	Neoprene/Chloroprene CR	Styrene-Butadiene SBR	Polyacrylate ACM	Polyurethane AU, EU	Butyl IIR	Butadiene BR	Isoprene IR	Natural Rubber NR	Hypalon CSM	Fluorosilicone FVMQ	Silicone MQ, VMQ, PVMQ
Dow Corning -710	E0540-80	2	2	1	1	1	1	X	1	1	1	1	1	1	1	1	1	2	3
Dow Corning F-61	N0674-70	1	1	1	1	1	1	1	1	X	X	X	X	X	X	X	X	X	X
Dow Guard	N0674-70	1	1	1	1	1	1	X	1	1	3	3	1	1	1	1	1	1	1
Dowanol P Mix	V3819-75	X	X	X	X	1	1	X	X	X	X	X	X	X	X	X	X	X	X
Dowtherm, 209	E0540-80	3	3	1	4	1	1	X	2	X	X	X	2	X	X	X	X	3	3
Dowtherm, A	V1164-75	4	4	4	1	1	1	X	4	4	4	4	4	4	4	4	4	2	4
Dowtherm, E	V1164-75	4	4	4	1	1	1	X	4	4	4	4	4	4	4	4	4	2	4
Drinking Water	E3609-70	1	1	1	1	1	1	X	2	1	4	4	1	1	1	1	1	1	1
Dry Cleaning Fluids	V1164-75	3	3	4	1	1	1	X	4	4	4	4	4	4	4	4	4	2	4
DTE 20 Series, Mobil	V1164-75	2	2	4	1	1	1	2	1	X	2	1	4	X	X	2	2	2	4
DTE named series, Mobil, light-heavy	N0674-70	1	1	4	1	1	1	2	2	4	X	1	4	4	X	3	1	1	3
- E -																			
Elco 28-EP lubricant	N0674-70	1	1	4	1	1	1	X	3	4	1	1	4	4	4	4	4	1	2
Epichlorohydrin	E0540-80	4	4	2	4	1	1	X	4	4	4	4	2	4	4	4	4	4	4
Epoxy Resins	E0540-80	X	X	1	4	1	1	X	1	X	X	X	1	X	X	X	X	X	X
Erucic Acid	V3819-75	X	X	X	X	1	1	X	X	X	X	X	X	X	X	X	X	X	X
Esam-6 Fluid	E0540-80	X	X	1	4	1	1	X	2	1	X	X	2	X	X	X	2	4	X
Esso Fuel 208	N0674-70	1	1	4	1	1	1	X	2	4	1	4	4	4	4	4	3	1	4
Esso Golden Gasoline	V1164-75	2	2	4	1	1	1	X	4	4	4	4	4	4	4	4	4	1	4
Esso Motor Oil	N0674-70	1	1	4	1	1	1	X	3	4	1	4	4	4	4	4	4	1	4
Esso Transmission Fluid (Type A)	N0674-70	1	1	4	1	1	1	X	2	4	1	3	4	4	4	4	4	1	4
Esso WS2812 (MIL-L-7808A)	V1164-75	1	1	4	1	1	1	X	4	4	2	4	4	4	4	4	4	1	4
Esso XP90-EP Lubricant	N0674-70	1	1	4	1	1	1	X	2	4	1	1	4	4	4	4	2	1	4
Esstic 42, 43	N0674-70	1	1	4	1	1	1	X	2	4	1	2	4	4	4	4	4	1	4
Ethane	N0674-70	1	1	4	1	1	1	X	2	4	1	3	4	4	4	4	2	3	4
Ethanol	E0540-80	3	3	1	3	1	1	X	1	1	4	4	1	1	1	1	1	1	2
Ethanol Amine	E0540-80	2	2	1	4	1	1	X	2	2	4	3	2	2	2	2	3	4	2
Ethers	V3819-75	4	4	3	3	1	1	X	4	4	3	2	4	4	4	4	3	4	4
Ethoxyethyl Acetate (EGMEEA)	E0540-80	3	3	1	3	2	1	X	1	1	4	4	1	1	1	1	1	1	2
Ethyl Acetate-Organic Ester	E0540-80	4	4	2	4	2	1	X	4	4	4	4	2	4	4	4	4	4	2
Ethyl Acetoacetate	E0540-80	4	4	2	4	1	1	X	4	3	4	4	2	3	3	3	4	4	2
Ethyl Acrylate	E0540-80	4	4	2	4	1	1	X	4	4	4	4	2	4	4	4	4	4	2
Ethyl Alcohol	E0540-80	3	3	1	3	1	1	X	1	1	4	4	1	1	1	1	1	1	2
Ethyl Ammonium Dichloride	V3819-75	X	X	X	X	1	1	X	X	X	X	X	X	X	X	X	X	X	X
Ethyl Benzene	V1164-75	4	4	4	1	1	1	X	4	4	4	4	4	4	4	4	4	1	4
Ethyl Benzoate	V1164-75	4	4	4	1	1	1	X	4	4	4	4	4	4	4	4	4	1	4
Ethyl Bromide	V1164-75	2	2	4	1	1	1	X	4	X	X	X	4	4	4	4	4	1	X

Approximate Service Temperature Ranges for Commonly Used Basic Polymer Types*

Nitrile (General Service)	-34°C to 121°C (-30°F to 250°F)*	AFLAS	-9°C to 232°C (15°F to 450°F)*
Nitrile (Low Temperature)	-55°C to 107°C (-65°F to 225°F)*	Neoprene	-51°C to 107°C (-60°F to 225°F)*
Hydrogenated Nitrile	-32°C to 149°C (-23°F to 300°F)*	Polyacrylate	-21°C to 177°C (-5°F to 350°F)*
Ethylene Propylene	-57°C to 121°C (-70°F to 250°F)*	Polyurethane	-40°C to 82°C (-40°F to 180°F)*
Fluorocarbon	-26°C to 205°C (-15°F to 400°F)*	Butyl	-59°C to 120°C (-75°F to 250°F)*
Hifluor	-26°C to 205°C (-15°F to 400°F)*	Fluorosilicone	-73°C to 177°C (-100°F to 350°F)*
Perfluoroelastomer (Parofluor)	-26°C to 320°C (-15°F to 608°F)*	Silicone	-115°C to 232°C (-175°F to 450°F)*

NOTE: *These temperature ranges will apply to the majority of media for which the material is potentially recommended. With some media however, the service temperature range may be significantly different. ALWAYS TEST UNDER ACTUAL SERVICE CONDITIONS.

WARNING: These products can expose you to chemicals including carbon black (airborne and extracts), antimony trioxide, titanium dioxide, silica (crystalline), di(2-ethylhexyl) phthalate, ethylene thiourea, acrylonitrile, 1,3-butadiene, epichlorohydrin, toluenediisocyanate, tetrafluoroethylene, ethylbenzene, formaldehyde, furfuryl alcohol, glass fibers, methyl isobutyl ketone, nickel (metallic and compounds), lead and lead compounds which are known to the State of California to cause cancer; and 1,3-butadiene, epichlorohydrin, di(2-ethylhexyl)phthalate, di-isodecyl phthalate, ethylene thiourea, methyl isobutyl ketone, methanol, toluene, lead and lead compounds which are known to the State of California to cause birth defects and other reproductive harm. For more information go to www.P65Warnings.ca.gov.

COMPOUND COMPATIBILITY RATING
 1 - Satisfactory
 2 - Fair (usually OK for static seal)
 3 - Doubtful (sometimes OK for static seal)
 4 - Unsatisfactory
 x - Insufficient Data

	Recommended	Nitrile NBR	Hydrogenated Nitrile HNBR	Ethylene Propylene EPDM	Fluorocarbon FKM	Hifluor FKM	Perfluoroelastomer FFKM	Aflas (TFE/Propylene) FEPDM	Neoprene/Chloroprene CR	Styrene-Butadiene SBR	Polyacrylate ACM	Polyurethane AU, EU	Butyl IIR	Butadiene BR	Isoprene IR	Natural Rubber NR	Hypalon CSM	Fluorosilicone FVMQ	Silicone MQ, VMQ, PVMQ
Ethyl Cellosolve	E0540-80	4	4	2	4	1	1	X	4	4	4	4	2	4	4	4	4	4	4
Ethyl Cellulose	N0674-70	2	2	2	4	1	1	X	2	2	4	2	2	2	2	2	2	4	2
Ethyl Chloride	N0674-70	1	1	3	1	1	1	X	4	4	3	2	4	2	1	4	4	1	4
Ethyl Chlorocarbonate	V1164-75	4	4	2	1	1	1	X	4	4	4	4	4	4	4	4	4	2	4
Ethyl Chloroformate	E0540-80	4	4	2	4	1	1	X	4	4	4	4	3	4	4	4	4	4	4
Ethyl Ether	Factory	3	3	3	4	1	1	X	4	4	4	2	3	4	4	4	4	3	4
Ethyl Formate	V1164-75	4	4	2	1	1	1	X	2	4	X	X	2	4	4	4	2	1	X
Ethyl Hexanol	N0674-70	1	1	1	1	1	1	X	1	1	4	4	1	1	1	1	1	1	2
Ethyl Lactate	E0540-80	3	3	1	3	1	1	X	1	1	4	4	1	1	1	1	1	1	2
Ethyl Mercaptan	V1164-75	4	4	X	2	1	1	X	3	4	X	X	4	4	4	4	3	X	3
Ethyl Nitrite	E0540-80	3	3	1	3	1	1	X	1	1	4	4	1	1	1	1	1	1	2
Ethyl Oxalate	E0540-80	4	4	1	2	1	1	X	4	4	4	X	4	4	1	4	4	2	4
Ethyl Pentachlorobenzene	V1164-75	4	4	4	1	1	1	X	4	4	4	4	4	4	4	4	4	2	4
Ethyl Pyridine	V1164-75	2	2	4	1	1	1	X	4	4	4	3	4	4	4	4	4	2	X
Ethyl Silicate	E0540-80	1	1	1	1	1	1	X	1	2	X	X	1	2	2	2	2	1	X
Ethyl Stearate	V1164-75	2	2	4	1	1	1	X	4	4	4	3	4	4	4	4	4	2	X
Ethyl Sulfate	E0540-80	X	X	1	4	1	1	1	X	X	X	X	X	X	X	X	X	X	X
Ethyl Tertiary Butyl Ether	V3819-75	X	X	X	X	2	1	X	X	X	X	X	X	X	X	X	X	X	X
Ethyl Valerate	V1164-75	2	2	4	1	1	1	X	4	4	4	3	4	4	4	4	4	2	X
Ethylacrylic Acid	E0540-80	4	4	2	X	X	X	X	2	4	4	4	2	4	4	4	4	4	4
Ethylamine	E0540-80	3	3	1	3	1	1	X	1	1	4	4	1	1	1	1	1	1	2
Ethylcyclopentane	N0674-70	1	1	4	1	1	1	X	3	4	2	1	4	4	4	4	4	1	4
Ethylene	V1164-75	3	2	4	2	1	1	X	4	4	4	4	4	4	4	4	4	2	4
Ethylene Chloride	V1164-75	4	4	4	2	1	1	X	4	4	4	4	4	4	4	4	4	2	4
Ethylene Chlorohydrin	V1164-75	4	4	2	1	1	1	X	2	2	4	4	2	2	2	2	2	2	3
Ethylene Cyanohydrin	V1164-75	2	2	4	1	1	1	X	4	4	4	3	4	4	4	4	4	2	X
Ethylene Diamine	E0540-80	1	1	1	4	2	2	X	1	2	4	4	1	2	1	1	2	4	1
Ethylene Dibromide	V1164-75	4	4	3	1	1	1	X	4	4	4	4	3	4	4	4	4	3	4
Ethylene Dichloride	V1164-75	4	4	3	1	1	1	X	4	4	4	4	3	4	4	4	4	3	4
Ethylene Glycol	E0540-80	1	1	1	1	1	1	X	1	1	4	2	1	1	1	1	1	1	1
Ethylene Hydrochloride	V1164-75	4	4	3	1	1	1	X	4	4	4	4	3	4	4	4	4	3	4
Ethylene Oxide	V8545-75	4	4	3	4	1	1	X	4	4	4	4	3	4	4	4	4	4	4
Ethylene Oxide, (12%) and Freon 12 (80%)	V3819-75	3	3	2	4	4	2	X	4	4	4	4	2	4	4	4	4	4	4
Ethylene Trichloride	V1164-75	4	4	3	1	1	1	X	4	4	4	4	3	4	4	4	4	3	4
Ethyleneimine	V3819-75	X	X	X	X	1	1	X	X	X	X	X	X	X	X	X	X	X	X
Ethylmorpholene Stannous Octotatate (50/50 mixture)	E0540-80	4	4	2	4	1	1	X	X	4	X	X	2	X	X	X	X	X	X
Ethylmorpholine	V1164-75	2	2	4	1	1	1	X	4	4	4	3	4	4	4	4	4	2	X
Ethylsulfuric Acid	E0540-80	3	3	1	3	1	1	X	1	1	4	4	1	1	1	1	1	1	2

Approximate Service Temperature Ranges for Commonly Used Basic Polymer Types*

Nitrile (General Service)	-34°C to 121°C (-30°F to 250°F)*	AFLAS	-9°C to 232°C (15°F to 450°F)*
Nitrile (Low Temperature)	-55°C to 107°C (-65°F to 225°F)*	Neoprene	-51°C to 107°C (-60°F to 225°F)*
Hydrogenated Nitrile	-32°C to 149°C (-23°F to 300°F)*	Polyacrylate	-21°C to 177°C (-5°F to 350°F)*
Ethylene Propylene	-57°C to 121°C (-70°F to 250°F)*	Polyurethane	-40°C to 82°C (-40°F to 180°F)*
Fluorocarbon	-26°C to 205°C (-15°F to 400°F)*	Butyl	-59°C to 120°C (-75°F to 250°F)*
Hifluor	-26°C to 205°C (-15°F to 400°F)*	Fluorosilicone	-73°C to 177°C (-100°F to 350°F)*
Perfluoroelastomer (Parofluor)	-26°C to 320°C (-15°F to 608°F)*	Silicone	-115°C to 232°C (-175°F to 450°F)*

NOTE: *These temperature ranges will apply to the majority of media for which the material is potentially recommended. With some media however, the service temperature range may be significantly different. ALWAYS TEST UNDER ACTUAL SERVICE CONDITIONS.



WARNING: These products can expose you to chemicals including carbon black (airborne and extracts), antimony trioxide, titanium dioxide, silica (crystalline), di(2-ethylhexyl) phthalate, ethylene thiourea, acrylonitrile, 1,3-butadiene, epichlorohydrin, toluenediisocyanate, tetrafluoroethylene, ethylbenzene, formaldehyde, furfuryl alcohol, glass fibers, methyl isobutyl ketone, nickel (metallic and compounds), lead and lead compounds which are known to the State of California to cause cancer; and 1,3-butadiene, epichlorohydrin, di(2-ethylhexyl)phthalate, di-isodecyl phthalate, ethylene thiourea, methyl isobutyl ketone, methanol, toluene, lead and lead compounds which are known to the State of California to cause birth defects and other reproductive harm. For more information go to www.P65Warnings.ca.gov.

COMPOUND COMPATIBILITY RATING
 1 - Satisfactory
 2 - Fair (usually OK for static seal)
 3 - Doubtful (sometimes OK for static seal)
 4 - Unsatisfactory
 x - Insufficient Data

	Recommended	Nitrile NBR	Hydrogenated Nitrile HNBR	Ethylene Propylene EPDM	Fluorocarbon FKM	Hifluor FKM	Perfluoroelastomer FFKM	Aflas (TFE/Propylene) FEPDM	Neoprene/Chloroprene CR	Styrene-Butadiene SBR	Polyacrylate ACM	Polyurethane AU, EU	Butyl IIR	Butadiene BR	Isoprene IR	Natural Rubber NR	Hypalon CSM	Fluorosilicone FVMQ	Silicone MQ, VMQ, PVMQ
- F -																			
F-60 Fluid (Dow Corning)	E0540-80	1	1	1	1	1	1	X	1	1	1	1	1	1	1	1	1	1	4
F-61 Fluid (Dow Corning)	E0540-80	1	1	1	1	1	1	X	1	1	1	1	1	1	1	1	1	1	4
Fatty Acids	V1164-75	2	2	3	1	1	1	X	2	4	X	X	3	4	4	4	2	X	3
FC-43 Heptacosofluorotri-butylamine	N0674-70	1	1	1	1	1	1	X	1	4	X	X	1	X	X	X	1	1	1
FC75 & FC77 (Fluorocarbon)	E0540-80	1	1	1	2	1	1	X	1	4	X	X	1	X	X	X	1	2	1
Ferric Acetate	E0540-80	3	3	1	3	1	1	X	1	1	4	4	1	1	1	1	1	1	2
Ferric Ammonium Sulfate	E0540-80	3	3	1	3	1	1	X	1	1	4	4	1	1	1	1	1	1	2
Ferric Chloride	N0674-70	1	1	1	1	1	1	X	2	1	1	1	1	1	1	1	2	1	2
Ferric Ferrocyanide	E0540-80	3	3	1	3	1	1	X	1	1	4	4	1	1	1	1	1	1	2
Ferric Hydroxide	E0540-80	3	3	1	3	1	1	X	1	1	4	4	1	1	1	1	1	1	2
Ferric Nitrate	N0674-70	1	1	1	1	1	1	X	1	1	1	1	1	1	1	1	1	1	2
Ferric Persulfate	N0674-70	1	1	1	1	1	1	1	X	X	X	X	X	X	X	X	X	X	X
Ferric Sulfate	N0674-70	1	1	1	1	1	1	1	X	X	X	X	X	X	X	X	X	X	X
Ferrous Ammonium Citrate	E0540-80	3	3	1	3	1	1	X	1	1	4	4	1	1	1	1	1	1	2
Ferrous Ammonium Sulfate	E0540-80	3	3	1	3	1	1	X	1	1	4	4	1	1	1	1	1	1	2
Ferrous Carbonate	E0540-80	3	3	1	3	1	1	X	1	1	4	4	1	1	1	1	1	1	2
Ferrous Chloride	N0674-70	X	X	X	X	1	1	X	X	X	X	X	X	X	X	X	X	X	X
Ferrous Iodide	E0540-80	3	3	1	3	1	1	X	1	1	4	4	1	1	1	1	1	1	2
Ferrous Sulfate	E0540-80	3	3	1	3	1	1	X	1	1	4	4	1	1	1	1	1	1	2
Ferrous Tartrate	E0540-80	3	3	1	3	1	1	X	1	1	4	4	1	1	1	1	1	1	2
Fish Oil	V1164-75	2	2	4	1	1	1	X	4	4	4	3	4	4	4	4	4	2	X
Fisher Reagent	E0540-80	X	X	2	X	X	X	X	X	X	X	X	X	X	X	X	X	X	X
Fluorinated Cyclic Ethers	V3819-75	X	X	1	X	1	1	X	X	X	X	X	X	X	X	X	X	X	X
Fluorine (Gas)	V3819-75	X	X	X	X	2	2	X	X	X	X	X	X	X	X	X	X	X	X
Fluorine (Liquid)	V1164-75	4	4	4	2	2	2	X	X	X	X	X	X	X	X	X	X	X	X
Fluorobenzene	V1164-75	2	2	4	1	1	1	X	4	4	4	3	4	4	4	4	4	2	X
Fluoroboric Acid	N0674-70	1	X	1	X	1	1	X	X	X	X	X	X	X	X	X	X	X	X
Fluorocarbon Oils	E0540-80	X	X	1	X	2	2	X	X	X	X	X	X	X	X	X	X	X	X
Fluoroform (Trifluoromethane)	FF500-75	X	X	X	X	1	1	X	X	X	X	X	X	X	X	X	X	X	X
Fluorolube	E0540-80	1	1	1	2	1	1	X	1	4	X	X	1	X	X	X	1	2	1
Fluorophosphoric Acid	V3819-75	X	X	X	X	1	1	X	X	X	X	X	X	X	X	X	X	X	X
Fluorosilicic Acid	N0674-70	1	1	2	2	1	1	1	X	X	X	X	X	X	X	X	X	X	X
Fluorosulfonic Acid	V3819-75	X	X	X	X	1	1	X	X	X	X	X	X	X	X	X	X	X	X
Formaldehyde	E0540-80	3	3	2	4	1	1	X	3	3	4	4	2	2	2	2	2	4	2
Formamide	E0540-80	3	3	1	3	1	1	X	1	1	4	4	1	1	1	1	1	3	2
Formic Acid	E0540-80	X	X	1	4	1	1	3	1	X	X	X	X	X	X	X	X	X	X
Freon, 11 (Trichlorofluoromethane)	V3819-75	4	4	4	2	2	2	X	4	4	4	X	4	X	X	4	1	2	4
Freon, 112 (Tetrachlorodifluoroethane)	V1164-75	2	2	4	1	1	1	X	2	4	X	X	4	X	X	4	2	X	4
Freon, 113 (Trichlorotrifluoroethane)	C0873-70	1	1	4	2	4	3	X	1	2	X	1	4	X	X	4	1	X	4
Freon, 113 + High and Low Aniline Oil	N0674-70	1	X	X	X	4	3	4	X	X	X	X	X	X	X	X	X	X	X

Approximate Service Temperature Ranges for Commonly Used Basic Polymer Types*

Nitrile (General Service)	-34°C to 121°C (-30°F to 250°F)*	AFLAS	-9°C to 232°C (15°F to 450°F)*
Nitrile (Low Temperature)	-55°C to 107°C (-65°F to 225°F)*	Neoprene	-51°C to 107°C (-60°F to 225°F)*
Hydrogenated Nitrile	-32°C to 149°C (-23°F to 300°F)*	Polyacrylate	-21°C to 177°C (-5°F to 350°F)*
Ethylene Propylene	-57°C to 121°C (-70°F to 250°F)*	Polyurethane	-40°C to 82°C (-40°F to 180°F)*
Fluorocarbon	-26°C to 205°C (-15°F to 400°F)*	Butyl	-59°C to 120°C (-75°F to 250°F)*
Hifluor	-26°C to 205°C (-15°F to 400°F)*	Fluorosilicone	-73°C to 177°C (-100°F to 350°F)*
Perfluoroelastomer (Parofluor)	-26°C to 320°C (-15°F to 608°F)*	Silicone	-115°C to 232°C (-175°F to 450°F)*

NOTE: *These temperature ranges will apply to the majority of media for which the material is potentially recommended. With some media however, the service temperature range may be significantly different. ALWAYS TEST UNDER ACTUAL SERVICE CONDITIONS.

WARNING: These products can expose you to chemicals including carbon black (airborne and extracts), antimony trioxide, titanium dioxide, silica (crystalline), di(2-ethylhexyl) phthalate, ethylene thiourea, acrylonitrile, 1,3-butadiene, epichlorohydrin, toluenediisocyanate, tetrafluoroethylene, ethylbenzene, formaldehyde, furfuryl alcohol, glass fibers, methyl isobutyl ketone, nickel (metallic and compounds), lead and lead compounds which are known to the State of California to cause cancer; and 1,3-butadiene, epichlorohydrin, di(2-ethylhexyl)phthalate, di-isodecyl phthalate, ethylene thiourea, methyl isobutyl ketone, methanol, toluene, lead and lead compounds which are known to the State of California to cause birth defects and other reproductive harm. For more information go to www.P65Warnings.ca.gov.

COMPOUND COMPATIBILITY RATING
 1 - Satisfactory
 2 - Fair (usually OK for static seal)
 3 - Doubtful (sometimes OK for static seal)
 4 - Unsatisfactory
 x - Insufficient Data

	Recommended	Nitrile NBR	Hydrogenated Nitrile HNBR	Ethylene Propylene EPDM	Fluorocarbon FKM	Hifluor FKM	Perfluoroelastomer FFKM	Aflas (TFE/Propylene) FEPDM	Neoprene/Chloroprene CR	Styrene-Butadiene SBR	Polyacrylate ACM	Polyurethane AU, EU	Butyl IIR	Butadiene BR	Isoprene IR	Natural Rubber NR	Hypalon CSM	Fluorosilicone FVMQ	Silicone MQ, VMQ, PVMQ
Freon, 114 (Dichlorotetrafluoroethane)	C0873-70	1	1	1	1	2	2	X	1	1	X	X	1	X	X	1	X	X	4
Freon, 114B2	C0873-70	2	2	4	2	2	2	X	2	4	X	X	4	X	X	4	1	X	4
Freon, 115, 116	C0873-70	1	1	1	2	2	2	X	1	1	X	X	1	X	X	1	X	X	X
Freon, 12 (Dichlorodifluoroethane)	C0873-70	2	2	3	3	2	2	X	1	1	X	1	3	4	4	2	1	3	4
Freon, 12 and ASTM Oil #2 (50/50 Mixture)	V1164-75	2	2	4	1	1	1	X	3	4	X	X	4	4	4	4	2	2	4
Freon, 12 and Suniso 4G (50/50 Mixture)	V1164-75	2	2	4	1	1	1	X	3	4	X	X	4	4	4	4	2	2	4
Freon, 123 (Dichlorotrifluoroethane)	C0873-70	X	X	X	X	4	4	X	X	X	X	X	X	X	X	X	X	X	X
Freon, 124 (Chlorotetrafluoroethane)	C0873-70	X	X	X	X	2	2	X	X	X	X	X	X	X	X	X	X	X	X
Freon, 125 (Pentafluoroethane)	V3819-75	X	X	X	X	2	2	X	X	X	X	X	X	X	X	X	X	X	X
Freon, 13 (Chlorotrifluoroethane)	C0873-70	1	1	1	1	1	1	X	1	1	X	X	1	X	1	1	1	4	4
Freon, 134a (Tetrafluoroethane)	C0873-70	1	1	1	4	4	3	X	1	X	X	X	X	X	X	X	X	4	4
Freon, 13B1 (Bromotrifluoromethane)	N0674-70	1	1	1	1	2	2	X	1	1	X	X	1	X	X	1	1	2	4
Freon, 14 (Tetrafluoromethane)	C0873-70	1	1	1	1	1	1	X	1	1	X	1	1	X	X	1	1	X	4
Freon, 141b (Dichlorofluoroethane)	Factory	X	X	X	X	1	1	X	X	X	X	X	X	X	X	X	X	X	X
Freon, 142b (Chlorotrifluoroethane)	V1164-75	2	2	4	2	4	3	4	1	X	X	X	X	X	X	X	X	X	X
Freon, 152a (Difluoroethane)	Factory	X	X	X	X	4	3	X	1	X	X	X	X	X	X	X	X	X	X
Freon, 21	Factory	4	4	4	4	1	1	X	3	4	X	X	4	4	4	4	4	X	4
Freon, 218	N0674-70	1	X	1	1	1	1	X	X	X	X	X	X	X	X	X	X	X	X
Freon, 22 (Chlorodifluoromethane)	C0873-70	4	4	3	4	4	4	X	1	1	2	4	3	X	X	1	1	4	4
Freon, 22 and ASTM Oil #2 (50/50 Mixture)	C0873-70	4	4	4	2	1	1	X	2	4	2	X	4	X	X	4	X	2	4
Freon, 23 (Fluoroform) (Trifluoromethane)	Factory	X	X	X	X	1	1	X	X	X	X	X	X	X	X	X	X	X	X
Freon, 31	C0873-70	4	4	1	4	2	2	X	1	2	X	X	1	X	X	2	2	X	X
Freon, 32	C0873-70	1	1	1	4	2	2	X	1	1	X	X	1	X	X	1	1	X	X
Freon, 356mcf	C0873-70	X	X	X	X	X	X	X	X	X	X	X	X	X	X	X	X	X	X
Freon, 401a	C0873-70	X	4	1	4	X	X	X	1	X	X	X	X	X	X	X	X	X	X
Freon, 402a	C0873-70	X	3	1	4	X	X	X	1	X	X	X	X	X	X	X	X	X	X
Freon, 404a	C0873-70	X	1	1	4	X	X	X	4	X	X	X	X	X	X	X	X	X	X
Freon, 407c	C0873-70	X	2	X	4	X	X	X	4	X	X	X	X	X	X	X	X	X	X
Freon, 410a	C0873-70	X	2	1	4	X	X	X	1	X	X	X	X	X	X	X	X	X	X
Freon, 410c	C0873-70	X	X	X	X	X	X	X	X	X	X	X	X	X	X	X	X	X	X
Freon, 502	C0873-70	2	2	1	2	2	2	X	1	1	X	X	1	X	X	1	X	X	X
Freon, 507	C0873-70	X	1	1	4	X	X	X	1	X	X	X	X	X	X	X	X	X	X
Freon, BF (R112)	V1164-75	2	2	4	1	2	2	X	2	4	X	X	4	X	X	4	2	X	4
Freon, C316	N0674-70	1	X	1	1	2	2	X	X	X	X	X	X	X	X	X	X	X	X
Freon, C318	C0873-70	1	1	1	2	2	2	X	1	1	X	X	1	X	X	1	1	X	X
Freon, K-142b	C0873-70	1	1	1	4	4	4	X	1	1	X	X	1	X	X	2	1	X	X
Freon, K-152a	C0873-70	1	1	1	4	4	4	X	1	1	X	X	1	X	X	1	4	X	X
Freon, MF (R11)	N0674-70	2	2	4	2	2	2	X	4	4	X	3	4	X	X	4	1	X	4
Freon, PCA (R113)	N0674-70	1	1	4	2	1	1	X	1	2	X	1	4	X	X	4	1	X	4
Freon, TA	N0674-70	1	X	2	3	2	2	X	X	X	X	X	X	X	X	X	X	X	X

Nitrile (General Service)	-34°C to 121°C (-30°F to 250°F)*	AFLAS	-9°C to 232°C (15°F to 450°F)*
Nitrile (Low Temperature)	-55°C to 107°C (-65°F to 225°F)*	Neoprene	-51°C to 107°C (-60°F to 225°F)*
Hydrogenated Nitrile	-32°C to 149°C (-23°F to 300°F)*	Polyacrylate	-21°C to 177°C (-5°F to 350°F)*
Ethylene Propylene	-57°C to 121°C (-70°F to 250°F)*	Polyurethane	-40°C to 82°C (-40°F to 180°F)*
Fluorocarbon	-26°C to 205°C (-15°F to 400°F)*	Butyl	-59°C to 120°C (-75°F to 250°F)*
Hifluor	-26°C to 205°C (-15°F to 400°F)*	Fluorosilicone	-73°C to 177°C (-100°F to 350°F)*
Perfluoroelastomer (Parofluor)	-26°C to 320°C (-15°F to 608°F)*	Silicone	-115°C to 232°C (-175°F to 450°F)*

NOTE: *These temperature ranges will apply to the majority of media for which the material is potentially recommended. With some media however, the service temperature range may be significantly different. ALWAYS TEST UNDER ACTUAL SERVICE CONDITIONS.

WARNING: These products can expose you to chemicals including carbon black (airborne and extracts), antimony trioxide, titanium dioxide, silica (crystalline), di(2-ethylhexyl) phthalate, ethylene thiourea, acrylonitrile, 1,3-butadiene, epichlorohydrin, toluenediisocyanate, tetrafluoroethylene, ethylbenzene, formaldehyde, furfuryl alcohol, glass fibers, methyl isobutyl ketone, nickel (metallic and compounds), lead and lead compounds which are known to the State of California to cause cancer; and 1,3-butadiene, epichlorohydrin, di(2-ethylhexyl)phthalate, di-isodecyl phthalate, ethylene thiourea, methyl isobutyl ketone, methanol, toluene, lead and lead compounds which are known to the State of California to cause birth defects and other reproductive harm. For more information go to www.P65Warnings.ca.gov.

COMPOUND COMPATIBILITY RATING
 1 - Satisfactory
 2 - Fair (usually OK for static seal)
 3 - Doubtful (sometimes OK for static seal)
 4 - Unsatisfactory
 x - Insufficient Data

	Recommended	Nitrile NBR	Hydrogenated Nitrile HNBR	Ethylene Propylene EPDM	Fluorocarbon FKM	Hifluor FKM	Perfluoroelastomer FFKM	Aflas (TFE/Propylene) FEPDM	Neoprene/Chloroprene CR	Styrene-Butadiene SBR	Polyacrylate ACM	Polyurethane AU, EU	Butyl IIR	Butadiene BR	Isoprene IR	Natural Rubber NR	Hypalon CSM	Fluorosilicone FVMQ	Silicone MQ, VMQ, PVMQ
Freon, TC	N0674-70	1	X	2	1	2	2	X	X	X	X	X	X	X	X	X	X	X	X
Freon, TF (R113)	N0674-70	1	1	4	2	2	2	X	1	2	X	1	4	X	X	4	1	X	4
Freon, TMC	V1164-75	2	X	3	1	2	2	X	X	X	X	X	X	X	X	X	X	X	X
Freon, T-P35	N0674-70	1	X	1	1	2	2	X	X	X	X	X	X	X	X	X	X	X	X
Freon, T-WD602	V1164-75	2	X	2	1	2	2	X	X	X	X	X	X	X	X	X	X	X	X
Frick #3 Compressor Oil	C0873-70	X	X	X	X	X	X	X	X	X	X	X	X	X	X	X	X	X	X
Fuel Oil, #6	V1164-75	2	2	4	1	1	1	X	4	4	1	2	4	4	4	4	4	1	1
Fuel Oil, 1, and 2	N0674-70	1	1	4	1	1	1	X	2	4	1	2	4	4	4	4	3	1	4
Fuel Oil, Acidic	N0674-70	1	1	4	1	1	1	X	2	4	1	2	4	4	4	4	4	1	4
Fumaric Acid	N0674-70	1	1	2	1	1	1	X	2	2	4	X	4	2	1	3	2	1	2
Fuming Sulphuric Acid (20/25% Oleum)	V1164-75	4	4	4	1	1	1	X	4	4	4	4	4	4	4	4	4	X	4
Furaldehyde	E0540-80	4	4	2	4	2	2	4	4	X	X	X	X	X	X	X	X	X	X
Furan (Furfuran)	V1164-75	4	4	3	1	1	1	X	4	4	4	X	4	4	4	4	4	X	X
Furfural (Furfuraldehyde)	E0540-80	4	4	2	4	1	1	X	4	4	4	3	2	4	4	4	3	X	4
Furfuraldehyde	E0540-80	4	4	2	4	1	1	X	4	4	4	3	2	4	4	4	3	X	4
Furfuryl Alcohol	E0540-80	4	4	2	X	1	1	X	4	4	4	4	2	4	4	4	4	4	4
Furoic Acid	V3819-75	X	X	X	X	1	1	X	X	X	X	X	X	X	X	X	X	X	X
Furyl Carbinol	E0540-80	4	4	2	X	X	X	X	4	4	4	4	2	4	4	4	4	4	4
Fyrquel 150 220 300 550	E0540-80	4	4	1	1	1	1	X	4	4	4	4	1	4	4	4	4	2	1
Fyrquel 90, 100, 500	E0540-80	4	4	1	1	1	1	X	X	X	X	X	X	X	X	X	X	X	X
Fyrquel A60	V3819-75	4	4	2	4	1	1	2	4	X	X	X	X	X	X	X	X	X	X
Fyrquel EHC	E0540-80	3	1	1	1	1	1	1	4	X	4	4	1	X	X	X	X	3	1
- G -																			
Galden	E0740-75	X	X	X	X	X	X	X	X	X	X	X	X	X	X	X	X	X	X
Gallic Acid	V1164-75	2	2	2	1	1	1	X	2	2	4	4	2	X	1	1	2	1	X
Gasoline	N1500-75	1	1	4	1	1	1	X	4	4	4	2	4	4	4	4	4	1	4
Gelatin	N0674-70	1	1	1	1	1	1	X	1	1	4	4	1	1	1	1	1	1	1
Germane (Germanium Tetrahydride)	V3819-75	X	X	X	X	1	1	X	X	X	X	X	X	X	X	X	X	X	X
Girling Brake Fluid	E0667-70	3	3	1	4	1	1	X	2	1	X	X	2	X	X	X	2	4	X
Glauber's Salt	V1164-75	4	4	2	1	1	1	X	2	4	4	X	2	4	2	2	2	1	X
Gluconic Acid	E0540-80	3	3	1	3	1	1	X	1	1	4	4	1	1	1	1	1	1	2
Glucose	N0674-70	1	1	1	1	1	1	X	1	1	X	4	1	1	1	1	1	1	1
Glue	V3819-75	X	X	X	X	1	1	X	X	X	X	X	X	X	X	X	X	X	X
Glutamic Acid	E0540-80	3	3	1	3	1	1	X	1	1	4	4	1	1	1	1	1	1	2
Glycerine (Glycerol)	N0674-70	1	1	1	1	1	1	X	1	1	4	4	1	1	1	1	1	1	1
Glycerol Dichlorohydrin	E0540-80	3	3	1	3	1	1	X	1	1	4	4	1	1	1	1	1	1	2
Glycerol Monochlorohydrin	E0540-80	3	3	1	3	1	1	X	1	1	4	4	1	1	1	1	1	1	2
Glycerol Triacetate	E0540-80	3	3	1	3	1	1	X	1	1	4	4	1	1	1	1	1	1	2

Approximate Service Temperature Ranges for Commonly Used Basic Polymer Types*

Nitrile (General Service)	-34°C to 121°C (-30°F to 250°F)*	AFLAS	-9°C to 232°C (15°F to 450°F)*
Nitrile (Low Temperature)	-55°C to 107°C (-65°F to 225°F)*	Neoprene	-51°C to 107°C (-60°F to 225°F)*
Hydrogenated Nitrile	-32°C to 149°C (-23°F to 300°F)*	Polyacrylate	-21°C to 177°C (-5°F to 350°F)*
Ethylene Propylene	-57°C to 121°C (-70°F to 250°F)*	Polyurethane	-40°C to 82°C (-40°F to 180°F)*
Fluorocarbon	-26°C to 205°C (-15°F to 400°F)*	Butyl	-59°C to 120°C (-75°F to 250°F)*
Hifluor	-26°C to 205°C (-15°F to 400°F)*	Fluorosilicone	-73°C to 177°C (-100°F to 350°F)*
Perfluoroelastomer (Parofluor)	-26°C to 320°C (-15°F to 608°F)*	Silicone	-115°C to 232°C (-175°F to 450°F)*

NOTE: *These temperature ranges will apply to the majority of media for which the material is potentially recommended. With some media however, the service temperature range may be significantly different. ALWAYS TEST UNDER ACTUAL SERVICE CONDITIONS.

WARNING: These products can expose you to chemicals including carbon black (airborne and extracts), antimony trioxide, titanium dioxide, silica (crystalline), di(2-ethylhexyl) phthalate, ethylene thiourea, acrylonitrile, 1,3-butadiene, epichlorohydrin, toluenediisocyanate, tetrafluoroethylene, ethylbenzene, formaldehyde, furfuryl alcohol, glass fibers, methyl isobutyl ketone, nickel (metallic and compounds), lead and lead compounds which are known to the State of California to cause cancer; and 1,3-butadiene, epichlorohydrin, di(2-ethylhexyl)phthalate, di-isodecyl phthalate, ethylene thiourea, methyl isobutyl ketone, methanol, toluene, lead and lead compounds which are known to the State of California to cause birth defects and other reproductive harm. For more information go to www.P65Warnings.ca.gov.

COMPOUND COMPATIBILITY RATING
 1 - Satisfactory
 2 - Fair (usually OK for static seal)
 3 - Doubtful (sometimes OK for static seal)
 4 - Unsatisfactory
 x - Insufficient Data

	Recommended	Nitrile NBR	Hydrogenated Nitrile HNBR	Ethylene Propylene EPDM	Fluorocarbon FKM	Hifluor FKM	Perfluoroelastomer FFKM	Aflas (TFE/Propylene) FEPDM	Neoprene/Chloroprene CR	Styrene-Butadiene SBR	Polyacrylate ACM	Polyurethane AU, EU	Butyl IIR	Butadiene BR	Isoprene IR	Natural Rubber NR	Hypalon CSM	Fluorosilicone FVMQ	Silicone MQ, VMQ, PVMQ
Glycerophosphoric Acid	E0540-80	3	3	1	3	1	1	X	1	1	4	4	1	1	1	1	1	1	2
Glyceryl Phosphate	E0540-80	3	3	1	3	1	1	X	1	1	4	4	1	1	1	1	1	1	2
Glycidol	E0540-80	3	3	1	3	1	1	X	1	1	4	4	1	1	1	1	1	1	2
Glycol Monoether	V3819-75	X	X	X	X	2	1	X	X	X	X	X	X	X	X	X	X	X	X
Glycolic Acid	E0540-80	3	3	1	3	1	1	X	1	1	4	4	1	1	1	1	1	1	2
Glycols	E0540-80	1	1	1	1	1	1	X	1	1	4	4	1	1	1	1	1	1	1
Glyoxylic Acid	E0540-80	3	3	1	3	1	1	X	1	1	4	4	1	1	1	1	1	1	2
Grease Petroleum Base	N0674-70	1	1	4	1	1	1	X	3	4	1	1	4	4	4	4	4	1	4
Green Sulfate Liquor	E0540-80	2	2	1	1	1	1	X	2	2	4	4	1	2	2	2	2	2	X
Gulf Endurance Oils	N0674-70	1	1	4	1	1	1	X	2	4	1	1	4	4	4	4	4	1	4
Gulf FR Fluids (Emulsion)	N0674-70	1	1	4	1	1	1	X	2	4	1	1	4	4	4	4	4	1	4
Gulf FR G-Fluids	E0540-80	1	1	1	1	1	1	X	1	1	4	2	1	1	1	1	1	1	1
Gulf FR P-Fluids	E0540-80	4	4	2	2	1	1	X	4	4	4	4	2	4	4	4	4	2	1
Gulf Harmony Oils	N0674-70	1	1	4	1	1	1	X	2	4	1	1	4	4	4	4	4	1	4
Gulf High Temperature Grease	N0674-70	1	1	4	1	1	1	X	2	4	1	1	4	4	4	4	4	1	4
Gulf Legion Oils	N0674-70	1	1	4	1	1	1	X	2	4	1	1	4	4	4	4	4	1	4
Gulf Paramount Oils	N0674-70	1	1	4	1	1	1	X	2	4	1	2	4	4	4	4	4	1	4
Gulf Security Oils	N0674-70	1	1	4	1	1	1	X	2	4	1	2	4	4	4	4	4	1	4
Gulfcrown Grease	N0674-70	1	1	4	1	1	1	X	2	4	1	1	4	4	4	4	4	1	4
- H -																			
Halothane	V1164-75	4	4	4	1	1	1	X	4	4	4	4	4	4	4	4	4	2	4
Halowax Oil	V1164-75	4	4	4	1	1	1	X	4	4	X	X	4	4	4	4	4	1	4
Hannifin Lube A	N0674-70	1	1	4	1	1	1	X	1	2	1	1	4	4	4	4	1	1	2
Heavy Water	N0674-70	1	1	1	X	1	1	X	2	1	4	4	1	1	1	1	1	1	1
HEF-2 (High Energy Fuel)	V1164-75	2	2	4	1	1	1	X	4	4	4	4	4	4	4	4	4	2	4
Helium	B0612-70	1	1	1	1	1	1	X	1	1	1	1	1	1	1	1	1	1	1
Heptachlor	V1164-75	2	2	4	1	1	1	X	4	4	4	3	4	4	4	4	4	2	X
Heptachlorobutene	V1164-75	2	2	4	1	1	1	X	4	4	4	3	4	4	4	4	4	2	X
Heptaldehyde (Heptanal)	N0674-70	1	1	4	1	1	1	X	2	4	1	1	4	4	4	4	2	1	2
Heptane or n-Heptane	N0674-70	1	1	4	1	1	1	X	2	4	1	2	4	4	4	4	2	3	4
Heptanoic Acid	N0674-70	1	1	4	1	1	1	X	2	4	1	1	4	4	4	4	2	1	2
Hexachloroacetone	E0540-80	3	3	1	3	1	1	X	1	1	4	4	1	1	1	1	1	1	2
Hexachlorobutadiene	V1164-75	2	2	4	1	1	1	X	4	4	4	3	4	4	4	4	4	2	X
Hexachlorobutene	V1164-75	2	2	4	1	1	1	X	4	4	4	3	4	4	4	4	4	2	X
Hexachloroethane	V1164-75	2	2	4	1	1	1	X	4	4	4	3	4	4	4	4	4	2	X
Hexaethyl Tetraphosphate	V3819-75	X	X	X	X	1	1	X	X	X	X	X	X	X	X	X	X	X	X
Hexafluoroethane (F-116)	V3819-75	X	X	X	X	2	2	X	X	X	X	X	X	X	X	X	X	X	X
Hexafluoroxylene	V3819-75	X	X	X	X	1	1	X	X	X	X	X	X	X	X	X	X	X	X
Hexafluoroxylene	V3819-75	X	X	X	X	1	1	X	X	X	X	X	X	X	X	X	X	X	X
Hexaldehyde or n-Hexaldehyde	E0540-80	4	4	1	4	1	1	X	1	4	X	2	2	4	4	4	3	4	2

Approximate Service Temperature Ranges for Commonly Used Basic Polymer Types*

Nitrile (General Service)	-34°C to 121°C (-30°F to 250°F)*	AFLAS	-9°C to 232°C (15°F to 450°F)*
Nitrile (Low Temperature)	-55°C to 107°C (-65°F to 225°F)*	Neoprene	-51°C to 107°C (-60°F to 225°F)*
Hydrogenated Nitrile	-32°C to 149°C (-23°F to 300°F)*	Polyacrylate	-21°C to 177°C (-5°F to 350°F)*
Ethylene Propylene	-57°C to 121°C (-70°F to 250°F)*	Polyurethane	-40°C to 82°C (-40°F to 180°F)*
Fluorocarbon	-26°C to 205°C (-15°F to 400°F)*	Butyl	-59°C to 120°C (-75°F to 250°F)*
Hifluor	-26°C to 205°C (-15°F to 400°F)*	Fluorosilicone	-73°C to 177°C (-100°F to 350°F)*
Perfluoroelastomer (Parofluor)	-26°C to 320°C (-15°F to 608°F)*	Silicone	-115°C to 232°C (-175°F to 450°F)*

NOTE: *These temperature ranges will apply to the majority of media for which the material is potentially recommended. With some media however, the service temperature range may be significantly different. ALWAYS TEST UNDER ACTUAL SERVICE CONDITIONS.



WARNING: These products can expose you to chemicals including carbon black (airborne and extracts), antimony trioxide, titanium dioxide, silica (crystalline), di(2-ethylhexyl) phthalate, ethylene thiourea, acrylonitrile, 1,3-butadiene, epichlorohydrin, toluenediisocyanate, tetrafluoroethylene, ethylbenzene, formaldehyde, furfuryl alcohol, glass fibers, methyl isobutyl ketone, nickel (metallic and compounds), lead and lead compounds which are known to the State of California to cause cancer; and 1,3-butadiene, epichlorohydrin, di(2-ethylhexyl)phthalate, di-isodecyl phthalate, ethylene thiourea, methyl isobutyl ketone, methanol, toluene, lead and lead compounds which are known to the State of California to cause birth defects and other reproductive harm. For more information go to www.P65Warnings.ca.gov.

COMPOUND COMPATIBILITY RATING
 1 - Satisfactory
 2 - Fair (usually OK for static seal)
 3 - Doubtful (sometimes OK for static seal)
 4 - Unsatisfactory
 x - Insufficient Data

	Recommended	Nitrile NBR	Hydrogenated Nitrile HNBR	Ethylene Propylene EPDM	Fluorocarbon FKM	Hifluor FKM	Perfluoroelastomer FFKM	Aflas (TFE/Propylene) FEPDM	Neoprene/Chloroprene CR	Styrene-Butadiene SBR	Polyacrylate ACM	Polyurethane AU, EU	Butyl IIR	Butadiene BR	Isoprene IR	Natural Rubber NR	Hypalon CSM	Fluorosilicone FVMQ	Silicone MQ, VMQ, PVMQ
Hexamethyldisilazane	V8545-75	X	X	X	X	1	1	X	X	X	X	X	X	X	X	X	X	X	X
Hexamethylene (Cyclohexane)	N0674-70	1	1	4	1	1	1	X	2	4	1	1	4	4	4	4	2	1	2
Hexamethylene Diammonium Adipate	V1164-75	2	2	4	1	1	1	X	4	4	4	3	4	4	4	4	4	2	X
Hexamethylenediamine	E0540-80	3	3	1	3	2	2	X	1	1	4	4	1	1	1	1	1	1	2
Hexamethylenetetramine	E0540-80	3	3	1	3	2	2	X	1	1	4	4	1	1	1	1	1	1	2
Hexane or n-Hexane	N0674-70	1	1	4	1	1	1	X	2	4	1	2	4	4	4	4	2	3	4
Hexene-1 or n-Hexene-1	V1164-75	2	2	4	1	1	1	X	2	4	1	2	4	4	4	4	2	4	4
Hexone (Methyl Isobutyl Ketone)	E0540-80	3	3	1	3	1	1	X	1	1	4	4	1	1	1	1	1	1	2
Hexyl Acetate	N0674-70	1	1	4	1	1	1	X	2	4	1	1	4	4	4	4	2	1	2
Hexyl Alcohol	N0674-70	1	1	3	1	1	1	X	2	1	4	4	3	1	1	1	2	2	2
Hexylene Glycol	E0540-80	3	3	1	3	1	1	X	1	1	4	4	1	1	1	1	1	1	2
Hexylresorcinol	V1164-75	2	2	4	1	1	1	X	4	4	4	3	4	4	4	4	4	2	X
HFC-245fa	C0873-70	X	X	X	X	X	X	X	X	X	X	X	X	X	X	X	X	X	X
High Viscosity Lubricant, H2	N0674-70	1	1	1	1	1	1	X	2	1	4	4	1	2	X	X	X	2	1
High Viscosity Lubricant, U4	N0674-70	1	1	1	1	1	1	X	2	1	4	4	1	2	X	X	X	2	1
HiLo MS #1	E0540-80	4	4	1	4	1	1	X	4	4	4	4	2	4	4	4	4	3	3
Houghto-Safe 1010 phosphate ester	E0540-80	4	4	1	1	1	1	X	4	4	4	X	1	4	4	4	4	2	3
Houghto-Safe 1055 phosphate ester	E0540-80	4	4	1	1	1	1	X	4	4	4	X	1	4	4	4	4	2	3
Houghto-Safe 1120 phosphate ester	V1164-75	4	4	2	1	1	1	X	4	4	4	4	1	4	4	4	4	2	3
Houghto-Safe 271 (Water & Glycol Base)	N0674-70	1	1	1	2	1	1	X	2	1	4	4	2	X	X	X	X	2	2
Houghto-Safe 416 & 500 Series	N0674-70	1	1	1	X	X	X	X	X	X	X	X	X	X	X	X	X	X	X
Houghto-Safe 5040 (Water/Oil emulsion)	N0674-70	1	1	4	1	1	1	X	2	4	4	4	4	4	4	4	4	2	3
Houghto-Safe 620 Water/Glycol	N0674-70	1	1	1	2	1	1	X	2	1	4	4	2	X	X	X	X	2	2
Hydraulic Oil (Petroleum Base, Industrial)	N0674-70	1	1	4	1	1	1	X	2	4	1	1	4	4	4	4	2	1	2
Hydraulic Oils (Synthetic Base)	V1164-75	2	2	4	1	1	1	X	4	4	4	3	4	4	4	4	4	2	X
Hydrazine	E0540-80	2	2	1	4	1	1	X	2	2	X	4	1	X	X	1	2	4	2
Hydrazine (Anhydrous)	E0540-80	4	4	2	4	1	1	2	2	1	4	4	2	4	4	4	2	4	X
Hydrazine Dihydrochloride	E0540-80	3	3	1	3	1	1	X	1	1	4	4	1	1	1	1	1	1	2
Hydrazine Hydrate	E0540-80	3	3	1	3	1	1	X	1	1	4	4	1	1	1	1	1	1	2
Hydriodic Acid	V1164-75	2	2	4	1	1	1	X	4	4	4	3	4	4	4	4	4	2	X
Hydroabietyl Alcohol	V3819-75	X	X	X	X	1	1	X	X	X	X	X	X	X	X	X	X	X	X
Hydrobromic Acid	E0540-80	4	4	1	1	1	1	X	4	4	4	4	1	4	1	1	1	3	4
Hydrobromic Acid 40%	E0540-80	4	4	1	1	1	1	X	2	4	4	4	1	4	1	1	1	3	4
Hydrocarbons, Saturated	N0674-70	1	1	4	1	1	1	X	2	4	1	2	4	4	4	4	3	1	4
Hydrochloric Acid (cold) 37%	V1164-75	4	X	3	1	1	1	4	X	X	X	X	X	X	X	X	X	X	X
Hydrochloric Acid (hot) 37%	V1164-75	4	X	3	1	1	1	X	4	4	4	3	4	4	4	4	4	2	X
Hydrochloric Acid, 3 Molar to 158°F	V1164-75	2	2	1	1	1	1	X	2	3	3	4	1	X	X	3	1	3	4
Hydrochloric Acid, Concentrated Room Temp.	V0834-70	2	2	2	1	1	1	X	X	X	X	X	X	X	X	X	X	X	X
Hydrochloric Acid, Concentrated to 158°F	V1164-75	4	4	4	1	1	1	X	4	4	4	4	4	X	X	4	X	4	4
Hydrocyanic Acid	E0540-80	2	2	1	1	1	1	X	2	2	4	X	1	2	1	1	1	2	3

Approximate Service Temperature Ranges for Commonly Used Basic Polymer Types*

Nitrile (General Service)	-34°C to 121°C (-30°F to 250°F)*	AFLAS	-9°C to 232°C (15°F to 450°F)*
Nitrile (Low Temperature)	-55°C to 107°C (-65°F to 225°F)*	Neoprene	-51°C to 107°C (-60°F to 225°F)*
Hydrogenated Nitrile	-32°C to 149°C (-23°F to 300°F)*	Polyacrylate	-21°C to 177°C (-5°F to 350°F)*
Ethylene Propylene	-57°C to 121°C (-70°F to 250°F)*	Polyurethane	-40°C to 82°C (-40°F to 180°F)*
Fluorocarbon	-26°C to 205°C (-15°F to 400°F)*	Butyl	-59°C to 120°C (-75°F to 250°F)*
Hifluor	-26°C to 205°C (-15°F to 400°F)*	Fluorosilicone	-73°C to 177°C (-100°F to 350°F)*
Perfluoroelastomer (Parofluor)	-26°C to 320°C (-15°F to 608°F)*	Silicone	-115°C to 232°C (-175°F to 450°F)*

NOTE: *These temperature ranges will apply to the majority of media for which the material is potentially recommended. With some media however, the service temperature range may be significantly different. ALWAYS TEST UNDER ACTUAL SERVICE CONDITIONS.

WARNING: These products can expose you to chemicals including carbon black (airborne and extracts), antimony trioxide, titanium dioxide, silica (crystalline), di(2-ethylhexyl) phthalate, ethylene thiourea, acrylonitrile, 1,3-butadiene, epichlorohydrin, toluenediisocyanate, tetrafluoroethylene, ethylbenzene, formaldehyde, furfuryl alcohol, glass fibers, methyl isobutyl ketone, nickel (metallic and compounds), lead and lead compounds which are known to the State of California to cause cancer; and 1,3-butadiene, epichlorohydrin, di(2-ethylhexyl)phthalate, di-isodecyl phthalate, ethylene thiourea, methyl isobutyl ketone, methanol, toluene, lead and lead compounds which are known to the State of California to cause birth defects and other reproductive harm. For more information go to www.P65Warnings.ca.gov.

COMPOUND COMPATIBILITY RATING
 1 - Satisfactory
 2 - Fair (usually OK for static seal)
 3 - Doubtful (sometimes OK for static seal)
 4 - Unsatisfactory
 x - Insufficient Data

	Recommended	Nitrile NBR	Hydrogenated Nitrile HNBR	Ethylene Propylene EPDM	Fluorocarbon FKM	Hifluor FKM	Perfluoroelastomer FFKM	Aflas (TFE/Propylene) FEPDM	Neoprene/Chloroprene CR	Styrene-Butadiene SBR	Polyacrylate ACM	Polyurethane AU, EU	Butyl IIR	Butadiene BR	Isoprene IR	Natural Rubber NR	Hypalon CSM	Fluorosilicone FVMQ	Silicone MQ, VMQ, PVMQ
Hydro-Drive MIH-10 (Petroleum Base)	N0674-70	1	1	4	1	1	1	X	2	4	1	2	4	4	4	4	4	1	2
Hydro-Drive MIH-50 (Petroleum Base)	N0674-70	1	1	4	1	1	1	X	2	4	1	2	4	4	4	4	4	1	2
Hydrofluoric Acid (Anhydrous)	V3819-75	X	X	X	X	1	1	X	X	X	X	X	X	X	X	X	X	X	X
Hydrofluoric Acid (conc.) Cold	V3819-75	X	X	X	X	1	1	X	X	X	X	X	X	X	X	X	X	X	X
Hydrofluoric Acid (conc.) Hot	V3819-75	4	X	4	3	1	1	X	X	X	X	X	X	X	X	X	X	X	X
Hydrofluorosilicic Acid	E0540-80	2	2	1	1	1	1	X	2	2	X	X	1	X	1	1	1	4	4
Hydrogen Bromide (Anhydrous)	V3819-75	X	X	X	X	1	1	X	X	X	X	X	X	X	X	X	X	X	X
Hydrogen Chloride (Anhydrous)	V3819-75	X	X	X	X	1	1	X	X	X	X	X	X	X	X	X	X	X	X
Hydrogen Chloride gas	E0540-80	4	X	1	1	1	1	2	X	X	X	X	X	X	X	X	X	X	X
Hydrogen Cyanide	V3819-75	X	X	X	X	1	1	X	X	X	X	X	X	X	X	X	X	X	X
Hydrogen Fluoride	V3819-75	X	X	X	X	1	1	X	X	X	X	X	X	X	X	X	X	X	X
Hydrogen Fluoride (Anhydrous)	E0540-80	4	4	1	4	1	1	2	X	4	4	X	1	4	4	4	X	4	X
Hydrogen Gas, Cold	E0540-80	1	1	1	1	1	1	X	1	2	2	1	1	1	1	2	1	3	3
Hydrogen Gas, Hot	E0540-80	1	1	1	1	1	1	X	1	2	2	1	1	1	1	2	1	3	3
Hydrogen Iodide (Anhydrous)	V3819-75	X	X	X	X	1	1	X	X	X	X	X	X	X	X	X	X	X	X
Hydrogen Peroxide	V1164-75	2	2	1	1	1	1	X	1	2	4	X	1	2	2	2	2	1	1
Hydrogen Peroxide 90%	V1164-75	4	4	3	1	1	1	X	4	4	4	X	3	4	4	4	3	2	2
Hydrogen Selenide	V3819-75	X	X	X	X	1	1	X	X	X	X	X	X	X	X	X	X	X	X
Hydrogen Sulfide, Dry, Cold	E0540-80	1	1	1	4	1	1	X	1	1	4	X	1	1	1	1	1	3	3
Hydrogen Sulfide, Dry, Hot	E0540-80	4	4	1	4	1	1	X	2	4	4	X	1	4	4	4	3	3	3
Hydrogen Sulfide, Wet, Cold	E0540-80	4	4	1	4	1	1	X	1	4	4	X	1	4	4	4	2	3	3
Hydrogen Sulfide, Wet, Hot	E0540-80	4	4	1	4	1	1	X	2	4	4	X	1	4	4	4	3	3	3
Hydrolube-Water/Ethylene Glycol	N0674-70	1	1	1	1	1	1	X	2	1	4	4	2	X	X	X	X	2	2
Hydrooxycitronellal	V1164-75	X	X	X	1	1	1	X	4	4	4	3	4	4	4	4	4	2	X
Hydroquinol	V1164-75	4	4	4	1	2	2	X	4	X	X	X	X	X	X	X	X	X	X
Hydroquinone	V1164-75	3	3	2	2	1	1	X	4	4	4	X	4	4	2	2	4	2	X
Hydroxyacetic Acid	E0540-80	3	3	1	3	1	1	X	1	1	4	4	1	1	1	1	1	1	2
Hydne	E0540-80	2	2	1	4	1	1	X	2	2	4	X	2	2	2	2	X	4	4
Hyjet	E1267-80	4	4	1	4	1	1	2	4	X	X	X	X	X	X	X	X	X	X
Hyjet IV and IVA	E1267-80	4	4	1	4	1	1	X	4	4	4	4	2	4	4	4	4	4	4
Hyjet S4	E1267-80	4	X	1	4	1	1	2	4	X	X	X	X	X	X	X	X	X	X
Hyjet W	E1267-80	4	4	1	4	1	1	2	4	X	X	X	X	X	X	X	X	X	X
Hypochlorous Acid	V0834-70	4	4	2	1	1	1	X	4	4	4	X	2	4	2	2	1	X	X
- -																			
Indole	V1164-75	X	X	X	1	1	1	X	4	4	4	3	4	4	4	4	4	2	X
Industron FF44	N0674-70	1	1	4	1	1	1	X	2	4	1	2	4	4	4	4	4	1	4
Industron FF48	N0674-70	1	1	4	1	1	1	X	2	4	1	2	4	4	4	4	4	1	4
Industron FF53	N0674-70	1	1	4	1	1	1	X	2	4	1	2	4	4	4	4	4	1	4
Industron FF80	N0674-70	1	1	4	1	1	1	X	2	4	1	2	4	4	4	4	4	1	4

Approximate Service Temperature Ranges for Commonly Used Basic Polymer Types*

Nitrile (General Service)	-34°C to 121°C (-30°F to 250°F)*	AFLAS	-9°C to 232°C (15°F to 450°F)*
Nitrile (Low Temperature)	-55°C to 107°C (-65°F to 225°F)*	Neoprene	-51°C to 107°C (-60°F to 225°F)*
Hydrogenated Nitrile	-32°C to 149°C (-23°F to 300°F)*	Polyacrylate	-21°C to 177°C (-5°F to 350°F)*
Ethylene Propylene	-57°C to 121°C (-70°F to 250°F)*	Polyurethane	-40°C to 82°C (-40°F to 180°F)*
Fluorocarbon	-26°C to 205°C (-15°F to 400°F)*	Butyl	-59°C to 120°C (-75°F to 250°F)*
Hifluor	-26°C to 205°C (-15°F to 400°F)*	Fluorosilicone	-73°C to 177°C (-100°F to 350°F)*
Perfluoroelastomer (Parofluor)	-26°C to 320°C (-15°F to 608°F)*	Silicone	-115°C to 232°C (-175°F to 450°F)*

NOTE: *These temperature ranges will apply to the majority of media for which the material is potentially recommended. With some media however, the service temperature range may be significantly different. ALWAYS TEST UNDER ACTUAL SERVICE CONDITIONS.

WARNING: These products can expose you to chemicals including carbon black (airborne and extracts), antimony trioxide, titanium dioxide, silica (crystalline), di(2-ethylhexyl) phthalate, ethylene thiourea, acrylonitrile, 1,3-butadiene, epichlorohydrin, toluenediisocyanate, tetrafluoroethylene, ethylbenzene, formaldehyde, furfuryl alcohol, glass fibers, methyl isobutyl ketone, nickel (metallic and compounds), lead and lead compounds which are known to the State of California to cause cancer; and 1,3-butadiene, epichlorohydrin, di(2-ethylhexyl)phthalate, di-isodecyl phthalate, ethylene thiourea, methyl isobutyl ketone, methanol, toluene, lead and lead compounds which are known to the State of California to cause birth defects and other reproductive harm. For more information go to www.P65Warnings.ca.gov.

COMPOUND COMPATIBILITY RATING
 1 - Satisfactory
 2 - Fair (usually OK for static seal)
 3 - Doubtful (sometimes OK for static seal)
 4 - Unsatisfactory
 x - Insufficient Data

	Recommended	Nitrile NBR	Hydrogenated Nitrile HNBR	Ethylene Propylene EPDM	Fluorocarbon FKM	Hifluor FKM	Perfluoroelastomer FFKM	Aflas (TFE/Propylene) FEPDM	Neoprene/Chloroprene CR	Styrene-Butadiene SBR	Polyacrylate ACM	Polyurethane AU, EU	Butyl IIR	Butadiene BR	Isoprene IR	Natural Rubber NR	Hypalon CSM	Fluorosilicone FVMQ	Silicone MQ, VMQ, PVMQ
Insulin	E0540-80	3	3	1	3	1	1	X	1	1	4	4	1	1	1	1	1	1	2
Iodic Acid	E0540-80	3	3	1	3	1	1	X	1	1	4	4	1	1	1	1	1	1	2
Iodine	V1164-75	2	2	2	1	1	1	X	4	2	X	X	2	X	4	X	2	1	X
Iodine Pentafluoride	Factory	4	4	4	4	2	2	X	4	4	4	4	4	4	4	4	4	4	4
Iodoform	V1164-75	X	X	4	1	1	1	X	4	4	4	3	4	4	4	4	4	2	X
Isoamyl Acetate	E0540-80	3	3	1	3	2	1	X	1	1	4	4	1	1	1	1	1	1	2
Isoamyl Butyrate	E0540-80	3	3	1	3	2	1	X	1	1	4	4	1	1	1	1	1	1	2
Isoamyl Valerate	E0540-80	3	3	1	3	2	1	X	1	1	4	4	1	1	1	1	1	1	2
Isoboreol	V1164-75	X	X	X	1	1	1	X	4	4	4	3	4	4	4	4	4	2	X
Isobutane	N0674-70	1	1	4	1	1	1	X	2	4	1	1	4	4	4	4	2	1	2
Isobutyl Acetate	E0540-80	3	3	1	3	2	1	X	1	1	4	4	1	1	1	1	1	1	2
Isobutyl Alcohol	E0540-80	2	2	1	1	1	1	X	1	2	4	4	1	2	1	1	1	2	1
Isobutyl Chloride	V1164-75	4	4	4	1	1	1	4	4	X	X	X	X	X	X	X	X	X	X
Isobutyl Ether	V3819-75	2	2	4	4	2	1	4	3	X	X	X	X	X	X	X	X	X	X
Isobutyl Methyl Ketone	E0540-80	3	3	1	3	2	1	X	1	1	4	4	1	1	1	1	1	1	2
Isobutyl n-Butyrate	E0540-80	4	4	1	1	1	1	X	4	4	4	X	1	4	4	4	4	1	X
Isobutyl Phosphate	E0540-80	3	3	1	3	1	1	X	1	1	4	4	1	1	1	1	1	1	2
Isobutylene	V1164-75	X	X	X	1	1	1	X	4	4	4	3	4	4	4	4	4	2	X
Isobutyraldehyde	E0540-80	3	2	2	4	2	2	4	3	X	X	X	X	X	X	X	X	X	X
Isobutyric Acid	N0674-70	1	1	2	4	1	1	3	4	X	X	X	X	X	X	X	X	X	2
Isocrotyl Chloride	V1164-75	X	X	X	1	1	1	X	4	4	4	3	4	4	4	4	4	2	X
Isodecanol	N0674-70	1	1	4	1	1	1	X	2	4	1	1	4	4	4	4	2	1	2
Isododecane	N0674-70	1	1	4	1	1	1	X	2	4	4	X	4	4	4	4	2	1	4
Isoeugenol	N0674-70	1	1	4	1	1	1	X	2	4	1	1	4	4	4	4	2	1	2
Isooctane	N0674-70	1	1	4	1	1	1	X	2	4	1	2	4	4	4	4	1	1	4
Isopar K	N0674-70	X	X	X	X	X	X	X	X	X	X	X	X	X	X	X	X	X	X
Isopentane	N0674-70	1	1	4	1	1	1	X	2	4	1	1	4	4	4	4	2	1	2
Isophorone (Ketone)	E0540-80	4	4	2	4	1	1	X	4	4	4	4	2	4	4	4	4	4	4
Isopropanol	E0540-80	2	2	1	1	1	1	X	2	2	4	4	1	2	1	1	1	2	1
Isopropyl Acetate	E0540-80	4	4	2	4	1	1	X	4	4	4	4	2	4	4	4	4	2	4
Isopropyl Alcohol	E0540-80	2	2	1	1	1	1	X	2	2	4	4	1	2	1	1	1	2	1
Isopropyl Chloride	V1164-75	4	4	4	1	1	1	X	4	4	4	4	4	4	4	4	4	2	4
Isopropyl Ether	N0674-70	2	2	4	4	1	1	X	3	4	3	2	4	4	4	4	3	3	4
Isopropylacetone	E0540-80	3	3	1	3	2	1	X	1	1	4	4	1	1	1	1	1	1	2
Isopropylamine	E0540-80	3	3	1	3	1	1	X	1	1	4	4	1	1	1	1	1	1	2
- J -																			
Jet Fuel A	V1164-75	2	2	4	1	1	1	2	4	4	4	3	4	4	4	4	4	2	X
JP-10	V1164-75	3	3	4	1	1	1	2	4	4	4	3	4	X	X	4	X	1	4
JP-3 (MIL-J-5624)	N0674-70	1	1	4	1	1	1	2	4	X	X	X	X	X	X	X	X	X	X
JP-4 (MIL-T-5624) (Jet A1)	N0602-70	1	1	4	1	1	1	2	4	4	2	2	4	4	4	4	4	2	4
JP-5 (MIL-T-5624)	N0602-70	1	1	4	1	1	1	2	4	4	2	2	4	4	4	4	4	2	4

Approximate Service Temperature Ranges for Commonly Used Basic Polymer Types*

Nitrile (General Service)	-34°C to 121°C (-30°F to 250°F)*	AFLAS	-9°C to 232°C (15°F to 450°F)*
Nitrile (Low Temperature)	-55°C to 107°C (-65°F to 225°F)*	Neoprene	-51°C to 107°C (-60°F to 225°F)*
Hydrogenated Nitrile	-32°C to 149°C (-23°F to 300°F)*	Polyacrylate	-21°C to 177°C (-5°F to 350°F)*
Ethylene Propylene	-57°C to 121°C (-70°F to 250°F)*	Polyurethane	-40°C to 82°C (-40°F to 180°F)*
Fluorocarbon	-26°C to 205°C (-15°F to 400°F)*	Butyl	-59°C to 120°C (-75°F to 250°F)*
Hifluor	-26°C to 205°C (-15°F to 400°F)*	Fluorosilicone	-73°C to 177°C (-100°F to 350°F)*
Perfluoroelastomer (Parofluor)	-26°C to 320°C (-15°F to 608°F)*	Silicone	-115°C to 232°C (-175°F to 450°F)*

NOTE: *These temperature ranges will apply to the majority of media for which the material is potentially recommended. With some media however, the service temperature range may be significantly different. ALWAYS TEST UNDER ACTUAL SERVICE CONDITIONS.

WARNING: These products can expose you to chemicals including carbon black (airborne and extracts), antimony trioxide, titanium dioxide, silica (crystalline), di(2-ethylhexyl) phthalate, ethylene thiourea, acrylonitrile, 1,3-butadiene, epichlorohydrin, toluenediisocyanate, tetrafluoroethylene, ethylbenzene, formaldehyde, furfuryl alcohol, glass fibers, methyl isobutyl ketone, nickel (metallic and compounds), lead and lead compounds which are known to the State of California to cause cancer; and 1,3-butadiene, epichlorohydrin, di(2-ethylhexyl)phthalate, di-isodecyl phthalate, ethylene thiourea, methyl isobutyl ketone, methanol, toluene, lead and lead compounds which are known to the State of California to cause birth defects and other reproductive harm. For more information go to www.P65Warnings.ca.gov.

Compatibility Tables for Gases, Fluids, Solids

COMPOUND COMPATIBILITY RATING
 1 - Satisfactory
 2 - Fair (usually OK for static seal)
 3 - Doubtful (sometimes OK for static seal)
 4 - Unsatisfactory
 x - Insufficient Data

	Recommended	Nitrile NBR	Hydrogenated Nitrile HNBR	Ethylene Propylene EPDM	Fluorocarbon FKM	Hifluor FKM	Perfluoroelastomer FFKM	Aflas (TFE/Propylene) FEPDM	Neoprene/Chloroprene CR	Styrene-Butadiene SBR	Polyacrylate ACM	Polyurethane AU, EU	Butyl IIR	Butadiene BR	Isoprene IR	Natural Rubber NR	Hypalon CSM	Fluorosilicone FVMQ	Silicone MQ, VMQ, PVMQ
JP-6 (MIL-J-25656)	N0602-70	1	1	4	1	1	1	2	4	4	2	2	4	4	4	4	4	2	4
JP-8 (MIL-T-83133) (Jet A)	N0602-70	1	1	4	1	1	1	2	3	4	1	1	4	X	X	4	X	2	4
JP-9 (MIL-F-81912)	V1164-75	3	3	4	1	1	1	2	4	4	4	3	4	X	X	4	X	2	4
JP-9 -11	V1164-75	4	4	4	1	1	1	2	4	4	4	4	4	X	X	4	X	2	4
JPX (MIL-F-25604)	N0674-70	1	1	4	4	1	1	2	2	X	X	X	X	X	X	X	X	X	X
- K -																			
Karl Fischer Reagent		X	X	X	X	X	X	X	X	X	X	X	X	X	X	X	X	X	X
Kel F Liquids	E0540-80	1	1	1	2	1	1	X	X	1	X	X	1	X	X	X	1	2	1
Kerosene (Similar to RP-1 and JP-1)	N0674-70	1	1	4	1	1	1	X	2	4	1	1	4	4	4	4	4	1	4
Keystone #87HX-Grease	N0674-70	1	1	4	1	1	1	X	4	4	1	1	4	4	4	4	4	1	4
- L -																			
Lacquer Solvents	V3819-75	4	4	4	4	1	1	X	4	4	4	4	4	4	4	4	4	4	4
Lacquers	V3819-75	4	4	4	4	1	1	X	4	4	4	4	4	4	4	4	4	4	4
Lactams-Amino Acids	E0540-80	4	4	2	4	1	1	X	2	4	X	X	2	4	4	4	2	4	X
Lactic Acid, Cold	N0674-70	1	1	1	1	1	1	X	1	1	4	X	1	1	1	1	1	1	1
Lactic Acid, Hot	V1164-75	4	4	4	1	1	1	X	4	4	4	X	4	4	4	4	3	2	2
Lactones (Cyclic Esters)	E0540-80	4	4	2	4	1	1	X	4	4	4	4	2	4	4	4	4	4	2
Lard Animal Fat	N0674-70	1	1	2	1	1	1	X	2	4	1	1	2	4	4	4	4	1	2
Lauric Acid	N0674-70	1	1	4	1	1	1	X	2	4	1	1	4	4	4	4	2	1	2
Lavender Oil	V1164-75	2	2	4	1	1	1	4	X	X	X	X	X	X	X	X	X	X	X
LB 135	N0674-70	1	1	1	1	1	1	1	X	X	X	X	X	X	X	X	X	X	X
Lead (Molten)	V3819-75	X	X	X	X	1	1	X	X	X	X	X	X	X	X	X	X	X	X
Lead Acetate	E0540-80	2	2	1	4	1	1	X	2	4	4	4	1	4	1	1	4	4	4
Lead Arsenate	E0540-80	3	3	1	3	1	1	X	1	1	4	4	1	1	1	1	1	1	2
Lead Azide	V3819-75	X	X	X	X	1	1	X	X	X	X	X	X	X	X	X	X	X	X
Lead Bromide	E0540-80	3	3	1	3	1	1	X	1	1	4	4	1	1	1	1	1	1	2
Lead Carbonate	E0540-80	3	3	1	3	1	1	X	1	1	4	4	1	1	1	1	1	1	2
Lead Chloride	E0540-80	3	3	1	3	1	1	X	1	1	4	4	1	1	1	1	1	1	2
Lead Chromate	E0540-80	3	3	1	3	1	1	X	1	1	4	4	1	1	1	1	1	1	2
Lead Dioxide	E0540-80	3	3	1	3	1	1	X	1	1	4	4	1	1	1	1	1	1	2
Lead Linoleate	E0540-80	3	3	1	3	1	1	X	1	1	4	4	1	1	1	1	1	1	2
Lead Naphthenate	V3819-75	X	X	X	X	1	1	X	X	X	X	X	X	X	X	X	X	X	X
Lead Nitrate	N0674-70	1	1	1	X	1	1	X	1	1	X	X	1	1	1	1	1	1	2
Lead Oxide	E0540-80	3	3	1	3	1	1	X	1	1	4	4	1	1	1	1	1	1	2
Lead Sulfamate	C0873-70	2	2	1	1	1	1	X	1	2	4	X	1	2	2	2	1	1	2
Lehigh X1169	N0674-70	1	1	4	1	1	1	X	2	4	1	1	4	4	4	4	2	1	4
Lehigh X1170	N0674-70	1	1	4	1	1	1	X	2	4	1	1	4	4	4	4	2	1	4
Light Grease	N0674-70	1	1	4	1	1	1	4	X	X	X	X	X	X	X	X	X	X	X
Ligroin (Petroleum Ether or Benzene)	N0674-70	1	1	4	1	1	1	X	2	4	1	2	4	4	4	4	3	1	4
Lime Bleach	N0674-70	1	1	1	1	1	1	1	X	X	X	X	X	X	X	X	X	X	X
Lime Sulfur	V1164-75	X	X	X	1	1	1	X	4	4	4	3	4	4	4	4	4	2	X

Approximate Service Temperature Ranges for Commonly Used Basic Polymer Types*

Nitrile (General Service)	-34°C to 121°C (-30°F to 250°F)*	AFLAS	-9°C to 232°C (15°F to 450°F)*
Nitrile (Low Temperature)	-55°C to 107°C (-65°F to 225°F)*	Neoprene	-51°C to 107°C (-60°F to 225°F)*
Hydrogenated Nitrile	-32°C to 149°C (-23°F to 300°F)*	Polyacrylate	-21°C to 177°C (-5°F to 350°F)*
Ethylene Propylene	-57°C to 121°C (-70°F to 250°F)*	Polyurethane	-40°C to 82°C (-40°F to 180°F)*
Fluorocarbon	-26°C to 205°C (-15°F to 400°F)*	Butyl	-59°C to 120°C (-75°F to 250°F)*
Hifluor	-26°C to 205°C (-15°F to 400°F)*	Fluorosilicone	-73°C to 177°C (-100°F to 350°F)*
Perfluoroelastomer (Parofluor)	-26°C to 320°C (-15°F to 608°F)*	Silicone	-115°C to 232°C (-175°F to 450°F)*

NOTE: *These temperature ranges will apply to the majority of media for which the material is potentially recommended. With some media however, the service temperature range may be significantly different. ALWAYS TEST UNDER ACTUAL SERVICE CONDITIONS.

WARNING: These products can expose you to chemicals including carbon black (airborne and extracts), antimony trioxide, titanium dioxide, silica (crystalline), di(2-ethylhexyl) phthalate, ethylene thiourea, acrylonitrile, 1,3-butadiene, epichlorohydrin, toluenediisocyanate, tetrafluoroethylene, ethylbenzene, formaldehyde, furfuryl alcohol, glass fibers, methyl isobutyl ketone, nickel (metallic and compounds), lead and lead compounds which are known to the State of California to cause cancer; and 1,3-butadiene, epichlorohydrin, di(2-ethylhexyl)phthalate, di-isodecyl phthalate, ethylene thiourea, methyl isobutyl ketone, methanol, toluene, lead and lead compounds which are known to the State of California to cause birth defects and other reproductive harm. For more information go to www.P65Warnings.ca.gov.

COMPOUND COMPATIBILITY RATING
 1 - Satisfactory
 2 - Fair (usually OK for static seal)
 3 - Doubtful (sometimes OK for static seal)
 4 - Unsatisfactory
 x - Insufficient Data

	Recommended	Nitrile NBR	Hydrogenated Nitrile HNBR	Ethylene Propylene EPDM	Fluorocarbon FKM	Hifluor FKM	Perfluoroelastomer FFKM	Aflas (TFE/Propylene) FEPDM	Neoprene/Chloroprene CR	Styrene-Butadiene SBR	Polyacrylate ACM	Polyurethane AU, EU	Butyl IIR	Butadiene BR	Isoprene IR	Natural Rubber NR	Hypalon CSM	Fluorosilicone FVMQ	Silicone MQ, VMQ, PVMQ
Lindol, Hydraulic Fluid (Phosphate ester type)	E0540-80	4	4	1	2	1	1	X	4	4	4	4	1	4	4	4	4	3	3
Linoleic Acid	S0604-70	2	2	4	2	1	1	X	2	4	X	X	4	4	4	4	2	X	2
Linseed Oil	N0674-70	1	1	3	1	1	1	X	3	4	1	2	3	4	4	4	2	1	1
Liquid Oxygen (LOX)	Factory	4	4	4	4	3	2	X	4	4	4	4	4	4	4	4	4	4	4
Liquid Petroleum Gas (LPG)	N0674-70	1	1	4	1	1	1	X	2	4	3	1	4	4	4	4	4	1	3
Liquimoly	N0674-70	1	1	4	1	1	1	X	2	4	1	2	4	4	4	4	4	1	4
Lithium Bromide (Brine)	E0540-80	3	3	1	3	1	1	X	1	1	4	4	1	1	1	1	1	1	2
Lithium Carbonate	E0540-80	3	3	1	3	1	1	X	1	1	4	4	1	1	1	1	1	1	2
Lithium Chloride	E0540-80	3	3	1	3	1	1	X	1	1	4	4	1	1	1	1	1	1	2
Lithium Citrate	E0540-80	3	3	1	3	1	1	X	1	1	4	4	1	1	1	1	1	1	2
Lithium Hydroxide	E0540-80	3	3	1	3	1	1	X	1	1	4	4	1	1	1	1	1	1	2
Lithium Hypochlorite	E0540-80	3	3	1	3	1	1	X	1	1	4	4	1	1	1	1	1	1	2
Lithium Nitrate	E0540-80	3	3	1	3	1	1	X	1	1	4	4	1	1	1	1	1	1	2
Lithium Nitrite	E0540-80	3	3	1	3	1	1	X	1	1	4	4	1	1	1	1	1	1	2
Lithium Perchlorate	E0540-80	3	3	1	3	1	1	X	1	1	4	4	1	1	1	1	1	1	2
Lithium Salicylate	E0540-80	3	3	1	3	1	1	X	1	1	4	4	1	1	1	1	1	1	2
Lithopone	E0540-80	3	3	1	3	1	1	X	1	1	4	4	1	1	1	1	1	1	2
Lubricating Oils (Crude & Refined)	V1164-75	2	2	4	1	1	1	3	X	X	X	X	X	X	X	X	X	X	X
Lubricating Oils (Synthetic base)	V1164-75	X	X	X	1	1	1	X	4	4	4	3	4	4	4	4	4	2	X
Lubricating Oils, Di-ester	V1164-75	2	2	4	1	1	1	X	3	4	2	X	4	4	4	4	X	2	4
Lubricating Oils, petroleum base	N0674-70	1	1	4	1	1	1	X	2	4	1	2	4	4	4	4	4	1	4
Lubricating Oils, SAE 10, 20, 30, 40, 50	N0674-70	1	1	4	1	1	1	X	2	4	1	2	4	4	4	4	4	1	4
Lye Solutions	E0540-80	2	2	1	2	1	1	X	2	2	4	4	1	2	2	1	1	2	2
- M -																			
Magnesium Chloride	N0674-70	1	1	1	1	1	1	X	1	1	X	1	1	1	1	1	1	1	1
Magnesium Hydroxide	E0540-80	2	2	1	1	1	1	X	2	2	4	4	1	2	2	2	1	X	X
Magnesium Salts	N0674-70	1	1	1	1	1	1	X	1	1	1	1	1	1	1	1	1	1	1
Magnesium Sulfite and Sulfate	N0674-70	1	1	1	1	1	1	X	1	2	4	X	1	2	2	2	1	1	1
Magnesium Trisilicate	V3819-75	X	X	X	X	1	1	X	X	X	X	X	X	X	X	X	X	X	X
Malathion	V1164-75	2	2	4	1	1	1	X	X	4	X	X	4	4	4	4	X	2	4
Maleic Acid	V1164-75	4	4	4	1	1	1	X	4	4	4	X	4	4	4	4	4	X	X
Maleic Anhydride	E0540-80	4	4	2	4	1	1	X	4	4	4	X	2	4	4	4	4	X	X
Maleic Hydrazide	E0540-80	3	3	1	3	1	1	X	1	1	4	4	1	1	1	1	1	1	2
Malic Acid	V1164-75	1	1	2	1	1	1	X	2	2	4	X	4	2	1	3	2	1	2
Mandelic Acid	E0540-80	3	3	1	3	1	1	X	1	1	4	4	1	1	1	1	1	1	2
Manganese Acetate	E0540-80	3	3	1	3	1	1	X	1	1	4	4	1	1	1	1	1	1	2
Manganese Carbonate	E0540-80	3	3	1	3	1	1	X	1	1	4	4	1	1	1	1	1	1	2
Manganese Chloride	E0540-80	3	3	1	3	1	1	X	1	1	4	4	1	1	1	1	1	1	2
Manganese Dioxide	E0540-80	3	3	1	3	1	1	X	1	1	4	4	1	1	1	1	1	1	2

Approximate Service Temperature Ranges for Commonly Used Basic Polymer Types*

Nitrile (General Service)	-34°C to 121°C (-30°F to 250°F)*	AFLAS	-9°C to 232°C (15°F to 450°F)*
Nitrile (Low Temperature)	-55°C to 107°C (-65°F to 225°F)*	Neoprene	-51°C to 107°C (-60°F to 225°F)*
Hydrogenated Nitrile	-32°C to 149°C (-23°F to 300°F)*	Polyacrylate	-21°C to 177°C (-5°F to 350°F)*
Ethylene Propylene	-57°C to 121°C (-70°F to 250°F)*	Polyurethane	-40°C to 82°C (-40°F to 180°F)*
Fluorocarbon	-26°C to 205°C (-15°F to 400°F)*	Butyl	-59°C to 120°C (-75°F to 250°F)*
Hifluor	-26°C to 205°C (-15°F to 400°F)*	Fluorosilicone	-73°C to 177°C (-100°F to 350°F)*
Perfluoroelastomer (Parofluor)	-26°C to 320°C (-15°F to 608°F)*	Silicone	-115°C to 232°C (-175°F to 450°F)*

NOTE: *These temperature ranges will apply to the majority of media for which the material is potentially recommended. With some media however, the service temperature range may be significantly different. ALWAYS TEST UNDER ACTUAL SERVICE CONDITIONS.

WARNING: These products can expose you to chemicals including carbon black (airborne and extracts), antimony trioxide, titanium dioxide, silica (crystalline), di(2-ethylhexyl) phthalate, ethylene thiourea, acrylonitrile, 1,3-butadiene, epichlorohydrin, toluenediisocyanate, tetrafluoroethylene, ethylbenzene, formaldehyde, furfuryl alcohol, glass fibers, methyl isobutyl ketone, nickel (metallic and compounds), lead and lead compounds which are known to the State of California to cause cancer; and 1,3-butadiene, epichlorohydrin, di(2-ethylhexyl)phthalate, di-isodecyl phthalate, ethylene thiourea, methyl isobutyl ketone, methanol, toluene, lead and lead compounds which are known to the State of California to cause birth defects and other reproductive harm. For more information go to www.P65Warnings.ca.gov.

Compatibility Tables for Gases, Fluids, Solids

COMPOUND COMPATIBILITY RATING
 1 - Satisfactory
 2 - Fair (usually OK for static seal)
 3 - Doubtful (sometimes OK for static seal)
 4 - Unsatisfactory
 x - Insufficient Data

	Recommended	Nitrile NBR	Hydrogenated Nitrile HNBR	Ethylene Propylene EPDM	Fluorocarbon FKM	Hifluor FKM	Perfluoroelastomer FFKM	Aflas (TFE/Propylene) FEPDM	Neoprene/Chloroprene CR	Styrene-Butadiene SBR	Polyacrylate ACM	Polyurethane AU, EU	Butyl IIR	Butadiene BR	Isoprene IR	Natural Rubber NR	Hypalon CSM	Fluorosilicone FVMQ	Silicone MQ, VMQ, PVMQ
Manganese Gluconate	E0540-80	3	3	1	3	1	1	X	1	1	4	4	1	1	1	1	1	1	2
Manganese Hypophosphite	E0540-80	3	3	1	3	1	1	X	1	1	4	4	1	1	1	1	1	1	2
Manganese Linoleate	E0540-80	3	3	1	3	1	1	X	1	1	4	4	1	1	1	1	1	1	2
Manganese Naphthenate	V3819-75	X	X	X	X	1	1	X	X	X	X	X	X	X	X	X	X	X	X
Manganese Phosphate	E0540-80	3	3	1	3	1	1	X	1	1	4	4	1	1	1	1	1	1	2
Manganese Sulfate	E0540-80	3	3	1	3	1	1	X	1	1	4	4	1	1	1	1	1	1	2
Manganous Chloride	E0540-80	3	3	1	3	1	1	X	1	1	4	4	1	1	1	1	1	1	2
Manganous Phosphate	E0540-80	3	3	1	3	1	1	X	1	1	4	4	1	1	1	1	1	1	2
Manganous Sulfate	E0540-80	3	3	1	3	1	1	X	1	1	4	4	1	1	1	1	1	1	2
Mannitol	E0540-80	3	3	1	3	1	1	X	1	1	4	4	1	1	1	1	1	1	2
MCS 312	V1164-75	4	4	4	1	1	1	X	4	4	4	X	4	4	4	4	X	1	1
MCS 352	E1267-80	4	4	1	4	1	1	X	4	4	4	4	2	4	4	4	4	3	3
MCS 463	E1267-80	4	4	1	4	1	1	X	4	4	4	4	2	4	4	4	4	3	3
MDI (Methylene di-p-phenylene isocyanate)	E0540-80	3	3	1	3	1	1	X	1	1	4	4	1	1	1	1	1	1	2
Mercaptan	N0674-70	1	1	4	1	1	1	X	2	4	1	1	4	4	4	4	2	1	2
Mercaptobenzothiazole (MBT)	V1164-75	X	X	X	1	1	1	X	4	4	4	3	4	4	4	4	4	2	X
Mercuric Acetate	E0540-80	3	3	1	3	1	1	X	1	1	4	4	1	1	1	1	1	1	2
Mercuric Chloride	N0674-70	1	1	1	1	1	1	X	1	1	X	X	1	1	1	1	1	X	X
Mercuric Cyanide	E0540-80	3	3	1	3	1	1	X	1	1	4	4	1	1	1	1	1	1	2
Mercuric Iodide	E0540-80	3	3	1	3	1	1	X	1	1	4	4	1	1	1	1	1	1	2
Mercuric Nitrate	E0540-80	3	3	1	3	1	1	X	1	1	4	4	1	1	1	1	1	1	2
Mercuric Sulfate	E0540-80	3	3	1	3	1	1	X	1	1	4	4	1	1	1	1	1	1	2
Mercuric Sulfite	E0540-80	3	3	1	3	1	1	X	1	1	4	4	1	1	1	1	1	1	2
Mercurous Nitrate	E0540-80	3	3	1	3	1	1	X	1	1	4	4	1	1	1	1	1	1	2
Mercury	N0674-70	1	1	1	1	1	1	X	1	1	X	X	1	1	1	1	1	X	X
Mercury Chloride	E0540-80	3	3	1	3	1	1	X	1	1	4	4	1	1	1	1	1	1	2
Mercury Fulminate	E0540-80	3	3	1	3	1	1	X	1	1	4	4	1	1	1	1	1	1	2
Mercury Salts	E0540-80	3	3	1	3	1	1	X	1	1	4	4	1	1	1	1	1	1	2
Mercury Vapors	E0540-80	1	1	1	1	1	1	X	1	1	X	X	1	1	1	1	1	X	X
Mesityl Oxide (Ketone)	E0540-80	4	4	2	4	1	1	X	4	4	4	4	2	4	4	4	4	4	4
Meta-Cresol	V1164-75	X	X	X	1	1	1	X	4	4	4	3	4	4	4	4	4	2	X
Metdehyde	E0540-80	3	3	1	3	1	1	X	1	1	4	4	1	1	1	1	1	1	2
Meta-Nitroaniline	E0540-80	3	3	1	3	1	1	X	1	1	4	4	1	1	1	1	1	1	2
Meta-Toluidine	V1164-75	X	X	X	1	1	1	X	4	4	4	3	4	4	4	4	4	2	X
Methacrylic Acid	E0540-80	3	3	1	3	1	1	X	1	1	4	4	1	1	1	1	1	1	2
Methylalyl Chloride	V1164-75	X	X	X	1	1	1	X	4	4	4	3	4	4	4	4	4	2	X
Methane	N0674-70	1	1	4	1	1	1	X	2	4	1	3	4	4	4	4	2	3	4
Methanol	E0540-80	4	4	1	4	1	1	X	1	1	4	4	1	1	1	1	1	1	1
Methoxychlor	V3819-75	X	X	X	X	1	1	X	X	X	X	X	X	X	X	X	X	X	X
Methoxyethanol (DGMMA)	E0540-80	3	3	1	3	1	1	X	1	1	4	4	1	1	1	1	1	1	2

Approximate Service Temperature Ranges for Commonly Used Basic Polymer Types*

Nitrile (General Service)	-34°C to 121°C (-30°F to 250°F)*	AFLAS	-9°C to 232°C (15°F to 450°F)*
Nitrile (Low Temperature)	-55°C to 107°C (-65°F to 225°F)*	Neoprene	-51°C to 107°C (-60°F to 225°F)*
Hydrogenated Nitrile	-32°C to 149°C (-23°F to 300°F)*	Polyacrylate	-21°C to 177°C (- 5°F to 350°F)*
Ethylene Propylene	-57°C to 121°C (-70°F to 250°F)*	Polyurethane	-40°C to 82°C (-40°F to 180°F)*
Fluorocarbon	-26°C to 205°C (-15°F to 400°F)*	Butyl	-59°C to 120°C (-75°F to 250°F)*
Hifluor	-26°C to 205°C (-15°F to 400°F)*	Fluorosilicone	-73°C to 177°C (-100°F to 350°F)*
Perfluoroelastomer (Parofluor)	-26°C to 320°C (-15°F to 608°F)*	Silicone	-115°C to 232°C (-175°F to 450°F)*

NOTE: *These temperature ranges will apply to the majority of media for which the material is potentially recommended. With some media however, the service temperature range may be significantly different. ALWAYS TEST UNDER ACTUAL SERVICE CONDITIONS.

WARNING: These products can expose you to chemicals including carbon black (airborne and extracts), antimony trioxide, titanium dioxide, silica (crystalline), di(2-ethylhexyl) phthalate, ethylene thiourea, acrylonitrile, 1,3-butadiene, epichlorohydrin, toluenediisocyanate, tetrafluoroethylene, ethylbenzene, formaldehyde, furfuryl alcohol, glass fibers, methyl isobutyl ketone, nickel (metallic and compounds), lead and lead compounds which are known to the State of California to cause cancer; and 1,3-butadiene, epichlorohydrin, di(2-ethylhexyl)phthalate, di-isodecyl phthalate, ethylene thiourea, methyl isobutyl ketone, methanol, toluene, lead and lead compounds which are known to the State of California to cause birth defects and other reproductive harm. For more information go to www.P65Warnings.ca.gov.

COMPOUND COMPATIBILITY RATING
 1 - Satisfactory
 2 - Fair (usually OK for static seal)
 3 - Doubtful (sometimes OK for static seal)
 4 - Unsatisfactory
 x - Insufficient Data

	Recommended	Nitrile NBR	Hydrogenated Nitrile HNBR	Ethylene Propylene EPDM	Fluorocarbon FKM	Hifluor FKM	Perfluoroelastomer FFKM	Aflas (TFE/Propylene) FEPDM	Neoprene/Chloroprene CR	Styrene-Butadiene SBR	Polyacrylate ACM	Polyurethane AU, EU	Butyl IIR	Butadiene BR	Isoprene IR	Natural Rubber NR	Hypalon CSM	Fluorosilicone FVMQ	Silicone MQ, VMQ, PVMQ
Methyl Abietate	V1164-75	X	X	X	1	1	1	X	4	4	4	3	4	4	4	4	4	2	X
Methyl Acetate	E0540-80	4	4	2	4	2	1	X	2	4	4	4	2	4	4	4	4	4	4
Methyl Acetoacetate	E0540-80	4	4	2	4	1	1	X	4	X	4	4	2	X	X	X	4	4	2
Methyl Acetophenone*	V1164-75	X	X	X	1	2	1	X	4	4	4	3	4	4	4	4	4	2	X
Methyl Acrylate	E0540-80	4	4	2	4	1	1	X	2	4	4	4	2	4	4	4	4	4	4
Methyl Alcohol	E0540-80	4	4	1	4	1	1	X	1	1	4	4	1	1	1	1	1	1	1
Methyl Amylketone	E0540-80	3	3	1	3	2	1	X	1	1	4	4	1	1	1	1	1	1	2
Methyl Anthranilate	V1164-75	X	X	X	1	1	1	X	4	4	4	3	4	4	4	4	4	2	X
Methyl Benzoate	V1164-75	4	4	4	1	1	1	X	4	4	4	4	4	4	4	4	4	1	4
Methyl Bromide	V1164-75	2	2	4	1	1	1	X	4	4	3	X	4	4	4	4	4	1	X
Methyl Butyl Ketone	E0540-80	4	4	1	4	2	1	X	4	4	4	4	1	4	4	4	4	4	4
Methyl Butyrate Cellosolve	E0540-80	3	3	1	3	1	1	X	1	1	4	4	1	1	1	1	1	1	2
Methyl Butyrate Chloride	E0540-80	3	3	1	3	1	1	X	1	1	4	4	1	1	1	1	1	1	2
Methyl Carbonate	V1164-75	4	4	4	1	1	1	X	4	4	4	4	4	4	4	4	4	2	4
Methyl Cellosolve	E0540-80	3	3	2	4	1	1	X	3	4	4	4	2	4	4	4	2	4	4
Methyl Cellulose	N0674-70	2	2	2	4	1	1	X	2	2	4	2	2	2	2	2	2	4	2
Methyl Chloride	V1164-75	4	4	3	1	1	1	X	4	4	4	4	3	4	4	4	4	2	4
Methyl Chloroacetate	E0540-80	3	3	1	3	2	1	X	1	1	4	4	1	1	1	1	1	1	2
Methyl Chloroform	V1164-75	4	4	4	1	1	1	4	4	X	X	X	X	X	X	X	X	X	X
Methyl Chloroformate	V1164-75	4	4	4	1	1	1	X	4	4	4	4	4	4	4	4	4	2	4
Methyl Chlorosilanes	V3819-75	X	X	X	X	1	1	X	X	X	X	X	X	X	X	X	X	X	X
Methyl Cyanide (Acetonitrile)	E0540-80	3	3	1	3	1	1	X	1	1	4	4	1	1	1	1	1	1	2
Methyl Cyclohexanone	N0674-70	1	1	4	1	1	1	X	2	4	1	1	4	4	4	4	2	1	2
Methyl Dichloride	V1164-75	X	X	X	1	1	1	X	4	4	4	3	4	4	4	4	4	2	X
Methyldiethanolamine (MDEA)		X	X	X	X	X	X	X	X	X	X	X	X	X	X	X	X	X	X
Methyl Ether	N0674-70	1	1	4	1	2	1	X	3	4	4	X	4	1	1	4	4	1	1
Methyl Ethyl Ketone (MEK)	E0540-80	4	4	1	4	2	1	X	4	4	4	4	1	4	4	4	4	4	4
Methyl Ethyl Ketone Peroxide	S0604-70	4	4	4	4	1	1	X	4	4	4	4	4	4	4	4	4	4	2
Methyl Ethyl Oleate	V1164-75	X	X	X	1	1	1	X	4	4	4	3	4	4	4	4	4	2	X
Methyl Formate	C0873-70	4	4	2	X	1	1	X	2	4	X	X	2	4	4	4	2	X	X
Methyl Hexyl Ketone (2-Octanone)	E0540-80	3	3	1	3	1	1	X	1	1	4	4	1	1	1	1	1	1	2
Methyl Iodide	N0674-70	1	1	4	1	1	1	X	2	4	1	1	4	4	4	4	2	1	2
Methyl Isobutyl Ketone (MIBK)	Factory	4	4	3	4	1	1	X	4	4	4	4	3	4	4	4	4	4	4
Methyl Isocyanate	E0540-80	3	3	1	3	1	1	X	1	1	4	4	1	1	1	1	1	1	2
Methyl Isopropyl Ketone	E0540-80	4	4	2	4	1	1	X	4	4	4	4	2	4	4	4	4	4	4
Methyl Isovalerate	V1164-75	X	X	X	1	1	1	X	4	4	4	3	4	4	4	4	4	2	X
Methyl Lactate	E0540-80	3	3	1	3	1	1	X	1	1	4	4	1	1	1	1	1	1	2
Methyl Mercaptan	E0540-80	X	X	1	X	1	1	X	X	X	X	X	1	X	X	X	X	X	X
Methyl Methacrylate	V3819-75	4	X	4	4	1	1	X	4	4	4	X	4	4	4	4	4	4	4
Methyl Oleate	V1164-75	4	4	2	1	1	1	X	4	4	X	X	2	4	X	4	4	2	X

Approximate Service Temperature Ranges for Commonly Used Basic Polymer Types*

Nitrile (General Service)	-34°C to 121°C (-30°F to 250°F)*	AFLAS	-9°C to 232°C (15°F to 450°F)*
Nitrile (Low Temperature)	-55°C to 107°C (-65°F to 225°F)*	Neoprene	-51°C to 107°C (-60°F to 225°F)*
Hydrogenated Nitrile	-32°C to 149°C (-23°F to 300°F)*	Polyacrylate	-21°C to 177°C (-5°F to 350°F)*
Ethylene Propylene	-57°C to 121°C (-70°F to 250°F)*	Polyurethane	-40°C to 82°C (-40°F to 180°F)*
Fluorocarbon	-26°C to 205°C (-15°F to 400°F)*	Butyl	-59°C to 120°C (-75°F to 250°F)*
Hifluor	-26°C to 205°C (-15°F to 400°F)*	Fluorosilicone	-73°C to 177°C (-100°F to 350°F)*
Perfluoroelastomer (Parofluor)	-26°C to 320°C (-15°F to 608°F)*	Silicone	-115°C to 232°C (-175°F to 450°F)*

NOTE: *These temperature ranges will apply to the majority of media for which the material is potentially recommended. With some media however, the service temperature range may be significantly different. ALWAYS TEST UNDER ACTUAL SERVICE CONDITIONS.

WARNING: These products can expose you to chemicals including carbon black (airborne and extracts), antimony trioxide, titanium dioxide, silica (crystalline), di(2-ethylhexyl) phthalate, ethylene thiourea, acrylonitrile, 1,3-butadiene, epichlorohydrin, toluenediisocyanate, tetrafluoroethylene, ethylbenzene, formaldehyde, furfuryl alcohol, glass fibers, methyl isobutyl ketone, nickel (metallic and compounds), lead and lead compounds which are known to the State of California to cause cancer; and 1,3-butadiene, epichlorohydrin, di(2-ethylhexyl)phthalate, di-isodecyl phthalate, ethylene thiourea, methyl isobutyl ketone, methanol, toluene, lead and lead compounds which are known to the State of California to cause birth defects and other reproductive harm. For more information go to www.P65Warnings.ca.gov.

Compatibility Tables for Gases, Fluids, Solids

COMPOUND COMPATIBILITY RATING
 1 - Satisfactory
 2 - Fair (usually OK for static seal)
 3 - Doubtful (sometimes OK for static seal)
 4 - Unsatisfactory
 x - Insufficient Data

	Recommended	Nitrile NBR	Hydrogenated Nitrile HNBR	Ethylene Propylene EPDM	Fluorocarbon FKM	Hifluor FKM	Perfluoroelastomer FFKM	Aflas (TFE/Propylene) FEPDM	Neoprene/Chloroprene CR	Styrene-Butadiene SBR	Polyacrylate ACM	Polyurethane AU, EU	Butyl IIR	Butadiene BR	Isoprene IR	Natural Rubber NR	Hypalon CSM	Fluorosilicone FVMQ	Silicone MQ, VMQ, PVMQ
Methyl Pentadiene	V1164-75	X	X	X	1	1	1	X	4	4	4	3	4	4	4	4	4	2	X
Methyl Phenylacetate	V1164-75	X	X	X	1	1	1	X	4	4	4	3	4	4	4	4	4	2	X
Methylphenyl Carbinol		X	X	X	X	X	X	X	X	X	X	X	X	X	X	X	X	X	X
Methyl Salicylate	E0540-80	4	4	2	X	1	1	X	4	3	X	X	2	X	X	3	4	X	X
Methyl Tertiary Butyl Ether (MTBE)	V3819-75	3	3	3	3	2	1	2	3	X	X	X	X	X	X	X	X	X	X
Methyl Valerate	V1164-75	X	X	X	1	1	1	X	4	4	4	3	4	4	4	4	4	2	X
Methyl-2-Pyrrolidone or n-Methyl-2-Pyrrolidone	E0540-80	X	X	2	X	1	1	X	X	X	X	X	X	X	X	X	X	X	X
Methylacrylic Acid	E0540-80	4	4	2	3	1	1	X	2	4	4	4	2	4	4	4	4	4	4
Methylal	V3819-75	X	X	X	X	1	1	X	X	X	X	X	X	X	X	X	X	X	X
Methylamine	E0540-80	3	3	1	3	1	1	X	1	1	4	4	1	1	1	1	1	1	2
Methylamyl Acetate	E0540-80	3	3	1	3	2	1	X	1	1	4	4	1	1	1	1	1	1	2
Methylcyclopentane	V1164-75	4	4	4	1	1	1	X	4	4	4	4	4	4	4	4	4	2	4
Methylene Bromide	V1164-75	X	X	X	1	1	1	X	4	4	4	3	4	4	4	4	4	2	X
Methylene Chloride	V1164-75	4	4	4	2	1	1	X	4	4	4	4	4	4	4	4	4	2	4
Methylene Iodide	V1164-75	X	X	X	1	1	1	X	4	4	4	3	4	4	4	4	4	2	X
Methylglycerol	E0540-80	3	3	1	3	1	1	X	1	1	4	4	1	1	1	1	1	1	2
Methylisobutyl Carbinol	N0674-70	1	1	4	1	1	1	X	2	4	1	1	4	4	4	4	2	1	2
Methylpyrrolidine	V1164-75	X	X	X	1	1	1	X	4	4	4	3	4	4	4	4	2	X	X
Methylpyrrolidone	V1164-75	X	X	X	1	1	1	X	4	4	4	3	4	4	4	4	2	X	X
Methylsulfuric Acid	E0540-80	3	3	1	3	1	1	X	1	1	4	4	1	1	1	1	1	1	2
MIL-A-6091	E1267-80	2	2	1	1	1	1	X	1	1	4	4	1	1	1	1	1	1	1
MIL-C-4339	N0304-75	1	1	4	1	1	1	X	4	4	1	1	4	4	4	4	1	3	
MIL-C-7024	N0602-70	1	1	4	1	1	1	X	2	4	2	1	4	4	4	4	1	4	
MIL-C-8188	V1164-75	2	2	4	2	1	1	X	4	4	3	4	4	4	4	4	2	4	
MIL-E-9500	E1267-80	1	1	1	1	1	1	X	1	1	4	4	1	1	1	1	1	1	1
MIL-F-16884	N0304-75	1	1	4	1	1	1	X	3	4	1	3	4	4	4	4	3	1	4
MIL-F-17111	N0304-75	1	1	4	1	1	1	X	2	4	1	3	4	4	4	4	2	2	4
MIL-F-25558 (RJ-1)	N0602-70	1	1	4	1	1	1	X	2	4	1	1	4	4	4	4	2	1	4
MIL-F-25656	N0602-70	1	1	4	1	1	1	X	4	4	2	2	4	4	4	4	2	4	
MIL-F-5566	E1267-80	2	2	1	1	1	1	X	2	2	4	2	1	2	1	1	1	1	1
MIL-F-81912 (JP-9)	V1164-75	3	3	4	1	1	1	X	4	4	4	3	4	X	X	4	X	2	4
MIL-F-82522 (RJ-4)	N0602-70	2	2	4	1	1	1	X	4	4	1	1	4	1	1	1	X	1	4
MIL-G-10924	N0304-75	1	1	4	1	1	1	X	2	4	2	1	4	4	4	4	2	1	4
MIL-G-15793	N0304-75	1	1	4	1	1	1	X	2	4	1	1	4	4	4	4	2	2	4
MIL-G-21568	E1267-80	1	1	1	1	1	1	X	1	1	1	1	1	1	1	1	1	1	4
MIL-G-23827		1	X	4	1	1	1	X	3	X	3	3	X	X	X	X	X	1	4
MIL-G-25013	V1164-75	1	1	1	1	1	1	X	2	1	1	3	1	4	4	2	2	1	4
MIL-G-25537	N0304-75	1	1	4	1	1	1	X	2	4	2	1	4	4	4	4	2	1	4
MIL-G-25760	V1164-75	2	2	4	1	1	1	X	2	4	2	2	4	4	4	4	2	2	4
MIL-G-3278	L1120-70	2	2	4	1	1	1	X	4	4	1	2	4	4	4	4	4	2	4

Approximate Service Temperature Ranges for Commonly Used Basic Polymer Types*

Nitrile (General Service)	-34°C to 121°C (-30°F to 250°F)*	AFLAS	-9°C to 232°C (15°F to 450°F)*
Nitrile (Low Temperature)	-55°C to 107°C (-65°F to 225°F)*	Neoprene	-51°C to 107°C (-60°F to 225°F)*
Hydrogenated Nitrile	-32°C to 149°C (-23°F to 300°F)*	Polyacrylate	-21°C to 177°C (-5°F to 350°F)*
Ethylene Propylene	-57°C to 121°C (-70°F to 250°F)*	Polyurethane	-40°C to 82°C (-40°F to 180°F)*
Fluorocarbon	-26°C to 205°C (-15°F to 400°F)*	Butyl	-59°C to 120°C (-75°F to 250°F)*
Hifluor	-26°C to 205°C (-15°F to 400°F)*	Fluorosilicone	-73°C to 177°C (-100°F to 350°F)*
Perfluoroelastomer (Parofluor)	-26°C to 320°C (-15°F to 608°F)*	Silicone	-115°C to 232°C (-175°F to 450°F)*

NOTE: *These temperature ranges will apply to the majority of media for which the material is potentially recommended. With some media however, the service temperature range may be significantly different. ALWAYS TEST UNDER ACTUAL SERVICE CONDITIONS.

WARNING: These products can expose you to chemicals including carbon black (airborne and extracts), antimony trioxide, titanium dioxide, silica (crystalline), di(2-ethylhexyl) phthalate, ethylene thiourea, acrylonitrile, 1,3-butadiene, epichlorohydrin, toluenediisocyanate, tetrafluoroethylene, ethylbenzene, formaldehyde, furfuryl alcohol, glass fibers, methyl isobutyl ketone, nickel (metallic and compounds), lead and lead compounds which are known to the State of California to cause cancer; and 1,3-butadiene, epichlorohydrin, di(2-ethylhexyl)phthalate, di-isodecyl phthalate, ethylene thiourea, methyl isobutyl ketone, methanol, toluene, lead and lead compounds which are known to the State of California to cause birth defects and other reproductive harm. For more information go to www.P65Warnings.ca.gov.

COMPOUND COMPATIBILITY RATING
 1 - Satisfactory
 2 - Fair (usually OK for static seal)
 3 - Doubtful (sometimes OK for static seal)
 4 - Unsatisfactory
 x - Insufficient Data

	Recommended	Nitrile NBR	Hydrogenated Nitrile HNBR	Ethylene Propylene EPDM	Fluorocarbon FKM	Hifluor FKM	Perfluoroelastomer FFKM	Aflas (TFE/Propylene) FEPDM	Neoprene/Chloroprene CR	Styrene-Butadiene SBR	Polyacrylate ACM	Polyurethane AU, EU	Butyl IIR	Butadiene BR	Isoprene IR	Natural Rubber NR	Hypalon CSM	Fluorosilicone FVMQ	Silicone MQ, VMQ, PVMQ
MIL-G-3545	N0304-75	1	1	4	1	1	1	X	2	4	1	1	4	4	4	4	2	1	4
MIL-G-4343	V1164-75	2	2	3	1	1	1	X	2	1	1	1	3	1	1	1	1	1	3
MIL-G-5572	N0602-70	1	1	4	1	1	1	X	4	4	2	2	4	4	4	4	4	1	4
MIL-G-7118	N0304-75	2	2	4	1	1	1	X	2	4	3	3	4	4	4	4	2	1	4
MIL-G-7187	N0304-75	1	1	4	1	1	1	X	4	4	1	1	4	4	4	4	4	1	4
MIL-G-7421	L1120-70	2	2	4	1	1	1	X	2	4	4	2	4	4	4	4	2	2	4
MIL-G-7711	N0304-75	1	1	4	1	1	1	X	4	4	2	1	4	4	4	4	4	1	2
MIL-H-13910	E1267-80	1	1	1	1	1	1	X	1	1	2	4	1	1	1	1	1	2	4
MIL-H-19457	V1164-75	4	4	2	1	1	1	X	4	4	4	4	1	4	4	4	4	4	3
MIL-H-22072	N0304-75	1	X	1	2	1	1	X	2	X	X	4	4	X	X	X	X	2	2
MIL-H-22251	E1267-80	2	2	1	X	X	X	X	2	2	X	X	1	X	X	X	X	2	4
MIL-H-27601	V1164-75	1	1	4	1	1	1	X	2	4	1	3	4	4	4	4	3	2	4
MIL-H-46170 -15°F to +400°F	V1164-75	1	1	4	1	1	1	X	2	4	2	2	4	4	4	4	2	1	4
MIL-H-46170 -20°F to +275°F	N0756-75	1	1	4	1	1	1	X	2	4	2	2	4	4	4	4	2	1	4
MIL-H-46170 -55°F to +275°F	N0756-75	1	1	4	1	1	1	X	2	4	2	2	4	4	4	4	2	1	4
MIL-H-46170 -65°F to +275°F	N0756-75	1	1	4	1	1	1	X	2	4	2	2	4	4	4	4	2	1	4
MIL-H-5606 -65°F to +235°F	N0756-75	1	1	4	1	1	1	X	2	4	2	2	4	4	4	4	2	1	4
MIL-H-5606 -65°F to +275°F	N0756-75	1	1	4	1	1	1	X	2	4	2	2	4	4	4	4	2	1	4
MIL-H-6083	N0304-75	1	1	4	1	1	1	X	1	4	1	1	4	4	4	2	2	1	4
MIL-H-7083	E1267-80	1	1	1	2	1	1	X	2	2	4	4	1	3	3	2	2	1	1
MIL-H-81019	LM158-70	1	X	4	1	1	1	X	2	X	1	2	4	X	X	X	X	1	3
MIL-H-8446 (MLO-8515)	V1164-75	2	2	4	1	1	1	X	1	4	3	4	4	4	4	4	X	1	4
MIL-J-5161	N0602-70	2	2	4	1	1	1	X	4	4	1	2	4	4	4	4	4	1	4
Milk	N0508-75	1	1	1	1	1	1	X	1	1	4	4	1	1	1	1	1	1	1
MIL-L-15016	N0304-75	1	1	4	1	1	1	X	2	4	1	1	4	4	4	4	2	2	4
MIL-L-15017	N0304-75	1	1	4	1	1	1	X	2	4	1	1	4	4	4	4	2	2	4
MIL-L-17331	V1164-75	1	1	4	1	1	1	X	X	4	X	X	4	4	4	4	X	X	4
MIL-L-2104	N0304-75	1	1	4	1	1	1	X	2	4	1	1	4	4	4	4	3	1	4
MIL-L-21260	N0304-75	1	1	4	1	1	1	X	2	4	1	1	4	4	4	4	2	1	4
MIL-L-23699	V1164-75	2	2	4	1	1	1	X	3	4	3	3	4	4	4	4	3	2	4
MIL-L-25681	V1164-75	2	2	1	1	1	1	X	2	2	2	3	1	2	2	2	2	2	4
MIL-L-3150	N0304-75	1	1	4	1	1	1	X	2	4	2	2	4	4	4	4	2	1	4
MIL-L-6081	N0304-75	1	1	4	1	1	1	X	2	4	1	1	4	4	4	4	2	1	4
MIL-L-6082	N0304-75	1	1	4	1	1	1	X	2	4	1	1	4	4	4	4	2	1	3
MIL-L-6085	V1164-75	2	2	4	1	1	1	X	4	4	2	3	4	4	4	4	4	2	4
MIL-L-6387	V1164-75	2	2	4	1	1	1	X	4	4	2	1	4	4	4	4	4	2	4
MIL-L-7808	V1164-75	2	2	4	1	1	1	X	4	4	2	4	4	4	4	4	4	2	4
MIL-L-7870	N0304-75	1	1	4	1	1	1	X	2	4	1	2	4	4	4	4	4	1	4
MIL-L-9000	N0304-75	1	1	4	1	1	1	X	2	4	1	3	4	4	4	4	2	2	4
MIL-L-9236	V1164-75	2	2	4	1	1	1	X	4	4	2	2	4	4	4	4	4	2	4

Approximate Service Temperature Ranges for Commonly Used Basic Polymer Types*

Nitrile (General Service)	-34°C to 121°C (-30°F to 250°F)*	AFLAS	-9°C to 232°C (15°F to 450°F)*
Nitrile (Low Temperature)	-55°C to 107°C (-65°F to 225°F)*	Neoprene	-51°C to 107°C (-60°F to 225°F)*
Hydrogenated Nitrile	-32°C to 149°C (-23°F to 300°F)*	Polyacrylate	-21°C to 177°C (-5°F to 350°F)*
Ethylene Propylene	-57°C to 121°C (-70°F to 250°F)*	Polyurethane	-40°C to 82°C (-40°F to 180°F)*
Fluorocarbon	-26°C to 205°C (-15°F to 400°F)*	Butyl	-59°C to 120°C (-75°F to 250°F)*
Hifluor	-26°C to 205°C (-15°F to 400°F)*	Fluorosilicone	-73°C to 177°C (-100°F to 350°F)*
Perfluoroelastomer (Parofluor)	-26°C to 320°C (-15°F to 608°F)*	Silicone	-115°C to 232°C (-175°F to 450°F)*

NOTE: *These temperature ranges will apply to the majority of media for which the material is potentially recommended. With some media however, the service temperature range may be significantly different. ALWAYS TEST UNDER ACTUAL SERVICE CONDITIONS.

WARNING: These products can expose you to chemicals including carbon black (airborne and extracts), antimony trioxide, titanium dioxide, silica (crystalline), di(2-ethylhexyl) phthalate, ethylene thiourea, acrylonitrile, 1,3-butadiene, epichlorohydrin, toluenediisocyanate, tetrafluoroethylene, ethylbenzene, formaldehyde, furfuryl alcohol, glass fibers, methyl isobutyl ketone, nickel (metallic and compounds), lead and lead compounds which are known to the State of California to cause cancer; and 1,3-butadiene, epichlorohydrin, di(2-ethylhexyl)phthalate, di-isodecyl phthalate, ethylene thiourea, methyl isobutyl ketone, methanol, toluene, lead and lead compounds which are known to the State of California to cause birth defects and other reproductive harm. For more information go to www.P65Warnings.ca.gov.

Compatibility Tables for Gases, Fluids, Solids

COMPOUND COMPATIBILITY RATING
 1 - Satisfactory
 2 - Fair (usually OK for static seal)
 3 - Doubtful (sometimes OK for static seal)
 4 - Unsatisfactory
 x - Insufficient Data

	Recommended	Nitrile NBR	Hydrogenated Nitrile HNBR	Ethylene Propylene EPDM	Fluorocarbon FKM	Hifluor FKM	Perfluoroelastomer FFKM	Aflas (TFE/Propylene) FEPDM	Neoprene/Chloroprene CR	Styrene-Butadiene SBR	Polyacrylate ACM	Polyurethane AU, EU	Butyl IIR	Butadiene BR	Isoprene IR	Natural Rubber NR	Hypalon CSM	Fluorosilicone FVMQ	Silicone MQ, VMQ, PVMQ
MIL-O-3503	N0304-75	1	1	4	1	1	1	X	2	4	2	1	4	4	4	4	2	1	4
MIL-P-27402	E1267-80	2	2	1	X	X	X	X	2	2	X	X	1	X	X	X	2	X	4
MIL-PRF-17672	N0304-70	X	X	X	X	X	X	X	X	X	X	X	X	X	X	X	X	X	X
MIL-PRF-2105	N0304-70	X	X	X	X	X	X	X	X	X	X	X	X	X	X	X	X	X	X
MIL-PRF-81322	N0304-70	1	1	4	1	1	1	1	2	4	1	1	4	4	4	4	X	1	3
MIL-PRF-87252	N0674-70	X	X	X	X	X	X	X	X	X	X	X	X	X	X	X	X	X	X
MIL-R-25576 (RP-1)	N0602-70	1	1	4	1	1	1	X	2	4	1	1	4	4	4	4	2	1	4
MIL-S-3136, Type I Fuel	N0602-70	1	1	4	1	1	1	X	2	4	1	1	4	4	4	4	2	1	4
MIL-S-3136, Type II Fuel	N0602-70	2	2	4	1	1	1	X	4	4	3	2	4	4	4	4	4	2	4
MIL-S-3136, Type III Fuel	N0602-70	2	2	4	1	1	1	X	4	4	3	2	4	4	4	4	4	2	4
MIL-S-3136, Type IV Oil High Swell	N0674-70	1	1	4	1	1	1	X	4	4	1	1	4	4	4	4	4	1	2
MIL-S-3136, Type IV Oil Low Swell	N0674-70	1	1	4	1	1	1	X	1	4	1	1	4	4	4	4	1	1	3
MIL-S-3136, Type V Oil Medium Swell	N0674-70	1	1	4	1	1	1	X	2	4	1	1	4	4	4	4	2	1	2
MIL-S-81087	E1267-80	1	1	1	1	1	1	X	1	1	1	1	1	1	1	1	1	2	3
MIL-T-5624, JP-4, JP-5	N0602-70	1	1	4	1	1	1	X	4	4	2	2	4	4	4	4	4	2	4
MIL-T-83133	N0602-70	1	1	4	1	1	1	X	3	4	1	1	4	X	X	4	X	2	4
Mineral Oils	N0674-70	1	1	3	1	1	1	X	2	4	1	1	3	4	4	4	2	1	2
Mixed Acids	E0540-80	3	3	1	3	1	1	X	1	1	4	4	1	1	1	1	1	1	2
MLO-7277 Hydr.	V1164-75	3	3	4	1	1	1	X	4	4	3	3	4	4	4	4	4	3	4
MLO-7557	V1164-75	3	3	4	1	1	1	X	4	4	3	3	4	4	4	4	4	3	4
MLO-8200 Hydr.	V1164-75	2	2	4	1	1	1	X	1	4	X	1	4	4	4	4	4	2	4
MLO-8515	V1164-75	2	2	4	1	1	1	X	1	4	3	1	4	4	4	4	3	1	4
Mobil DTE 20 Series	N0674-70	1	1	4	1	1	1	1	2	X	X	X	X	X	X	X	X	X	X
Mobil 254 Lubricant	V3819-75	X	X	X	X	1	1	X	X	X	X	X	X	X	X	X	X	X	X
Mobil Delvac 1100, 1110, 1120, 1130	N0674-70	1	1	4	1	1	1	1	2	X	X	X	X	X	X	X	X	X	X
Mobil HF	N0674-70	1	1	4	1	1	1	X	2	X	X	X	X	X	X	X	X	X	X
Mobil Nivac 20, 30	N0674-70	1	1	1	1	1	1	1	1	X	X	X	X	X	X	X	X	X	X
Mobil SHC 500 Series	V1164-75	3	3	4	1	1	1	X	2	X	1	2	4	X	X	X	2	2	2
Mobil SHC 600 Series	V1164-75	3	3	4	1	1	1	X	2	4	1	1	4	X	X	X	2	2	3
Mobil Therm 600	N0674-70	1	1	4	1	1	1	1	2	X	X	X	X	X	X	X	X	X	X
Mobil Velocite c	N0674-70	1	1	4	1	1	1	1	2	X	X	X	X	X	X	X	X	X	X
Mobilgas WA200 ATF	N0674-70	1	1	4	1	1	1	1	2	X	X	X	X	X	X	X	X	X	X
Mobilgear 600 Series	V1164-75	3	3	3	1	1	1	X	1	4	1	2	3	3	4	4	2	1	1
Mobilgear SHC ISO Series	V1164-75	3	3	3	1	1	1	X	2	4	1	2	3	3	4	4	2	1	1
Mobilgrease HP	V1164-75	2	2	4	1	1	1	X	2	4	1	1	4	X	4	4	3	1	2
Mobilgrease HTS	V1164-75	2	2	4	1	1	1	X	2	4	1	1	4	X	4	4	3	1	2
Mobilgrease SM	V1164-75	2	2	4	1	1	1	X	2	4	1	1	4	X	4	4	3	1	2
Mobilith AW Series	V1164-75	2	2	4	1	1	1	X	2	4	1	1	4	X	4	4	3	1	2
Mobilith SHC Series	V1164-75	2	2	4	1	1	1	X	3	4	1	1	4	X	4	4	3	1	2
Mobiljet 291	VM835-75	X	X	X	X	X	X	X	X	X	X	X	X	X	X	X	X	X	X

Approximate Service Temperature Ranges for Commonly Used Basic Polymer Types*

Nitrile (General Service)	-34°C to 121°C (-30°F to 250°F)*	AFLAS	-9°C to 232°C (15°F to 450°F)*
Nitrile (Low Temperature)	-55°C to 107°C (-65°F to 225°F)*	Neoprene	-51°C to 107°C (-60°F to 225°F)*
Hydrogenated Nitrile	-32°C to 149°C (-23°F to 300°F)*	Polyacrylate	-21°C to 177°C (-5°F to 350°F)*
Ethylene Propylene	-57°C to 121°C (-70°F to 250°F)*	Polyurethane	-40°C to 82°C (-40°F to 180°F)*
Fluorocarbon	-26°C to 205°C (-15°F to 400°F)*	Butyl	-59°C to 120°C (-75°F to 250°F)*
Hifluor	-26°C to 205°C (-15°F to 400°F)*	Fluorosilicone	-73°C to 177°C (-100°F to 350°F)*
Perfluoroelastomer (Parofluor)	-26°C to 320°C (-15°F to 608°F)*	Silicone	-115°C to 232°C (-175°F to 450°F)*

NOTE: *These temperature ranges will apply to the majority of media for which the material is potentially recommended. With some media however, the service temperature range may be significantly different. ALWAYS TEST UNDER ACTUAL SERVICE CONDITIONS.



WARNING: These products can expose you to chemicals including carbon black (airborne and extracts), antimony trioxide, titanium dioxide, silica (crystalline), di(2-ethylhexyl) phthalate, ethylene thiourea, acrylonitrile, 1,3-butadiene, epichlorohydrin, toluenediisocyanate, tetrafluoroethylene, ethylbenzene, formaldehyde, furfuryl alcohol, glass fibers, methyl isobutyl ketone, nickel (metallic and compounds), lead and lead compounds which are known to the State of California to cause cancer; and 1,3-butadiene, epichlorohydrin, di(2-ethylhexyl)phthalate, di-isodecyl phthalate, ethylene thiourea, methyl isobutyl ketone, methanol, toluene, lead and lead compounds which are known to the State of California to cause birth defects and other reproductive harm. For more information go to www.P65Warnings.ca.gov.

COMPOUND COMPATIBILITY RATING
 1 - Satisfactory
 2 - Fair (usually OK for static seal)
 3 - Doubtful (sometimes OK for static seal)
 4 - Unsatisfactory
 x - Insufficient Data

	Recommended	Nitrile NBR	Hydrogenated Nitrile HNBR	Ethylene Propylene EPDM	Fluorocarbon FKM	Hifluor FKM	Perfluoroelastomer FFKM	Aflas (TFE/Propylene) FEPDM	Neoprene/Chloroprene CR	Styrene-Butadiene SBR	Polyacrylate ACM	Polyurethane AU, EU	Butyl IIR	Butadiene BR	Isoprene IR	Natural Rubber NR	Hypalon CSM	Fluorosilicone FVMQ	Silicone MQ, VMQ, PVMQ
Mobiljet II Lubricant	V3819-75	X	X	X	X	1	1	X	X	X	X	X	X	X	X	X	X	X	X
Mobilmistlube Series	V1164-75	3	3	3	1	1	1	X	1	4	1	2	3	3	4	4	2	1	1
Mobiloil SAE 20	N0674-70	1	1	4	1	1	1	1	2	4	1	1	4	4	4	4	X	1	X
Mobilux	N0674-70	1	1	4	1	1	1	1	2	X	X	X	X	X	X	X	X	X	X
Molybdenum Disulfide Grease	N0674-70	1	X	4	1	1	1	1	4	X	X	X	X	X	X	X	X	X	X
Molybdenum Oxide	E0540-80	3	3	1	3	1	1	X	1	1	4	4	1	1	1	1	1	1	2
Molybdenum Trioxide	E0540-80	3	3	1	3	1	1	X	1	1	4	4	1	1	1	1	1	1	2
Molybdic Acid	E0540-80	3	3	1	3	1	1	X	1	1	4	4	1	1	1	1	1	1	2
Monobromobenzene	V1164-75	4	4	4	1	1	1	X	4	4	4	4	4	4	4	4	4	2	4
Monobromotoluene	V1164-75	X	X	X	1	1	1	X	4	4	4	3	4	4	4	4	4	2	X
Monobutyl Paracresol	V3819-75	X	X	X	X	1	1	X	X	X	X	X	X	X	X	X	X	X	X
Monochloroacetic Acid	E0540-80	3	3	1	3	1	1	X	1	1	4	4	1	1	1	1	1	1	2
Monochlorobenzene	V1164-75	4	4	4	1	1	1	X	4	4	4	4	4	4	4	4	4	2	4
Monochlorobutene	V1164-75	X	X	X	1	1	1	X	4	4	4	3	4	4	4	4	4	2	X
Monochlorohydrin	V3819-75	X	X	X	X	1	1	X	X	X	X	X	X	X	X	X	X	X	X
Monoethanolamine (MEA)	E0540-80	4	4	2	4	2	1	X	4	2	4	4	2	2	2	2	4	4	2
Monoethyl Amine	E0540-80	3	3	1	3	1	1	X	1	1	4	4	1	1	1	1	1	1	2
Monoisopropylamine	E0540-80	3	3	1	3	1	1	X	1	1	4	4	1	1	1	1	1	1	2
Monomethyl Aniline	E0540-80	4	X	1	2	1	1	X	1	1	4	4	1	1	1	1	1	1	2
Monomethyl Ether (Dimethyl Ether)	V3819-75	X	X	X	X	2	1	X	X	X	X	X	X	X	X	X	X	X	X
Monomethyl Ether (Methyl Ether)	N0674-70	1	X	4	1	1	1	X	X	X	X	X	X	X	X	X	X	X	X
Monomethyl Hydrazine	E0540-80	2	2	1	X	1	1	X	2	2	X	X	1	X	X	X	2	X	4
Monomethylamine (MMA)	E0540-80	3	3	1	3	1	1	X	1	1	4	4	1	1	1	1	1	1	2
Monomethylaniline	V1164-75	4	4	2	2	1	1	X	4	4	4	4	2	4	4	4	4	X	X
Mononitrotoluene	E0540-80	3	3	1	3	1	1	X	1	1	4	4	1	1	1	1	1	1	2
Mononitrotoluene & Dinitrotoluene (40/60 Mixture)	E0540-80	4	4	1	3	2	2	X	4	4	4	4	4	4	4	4	4	3	4
Monovinyl Acetylene	E0540-80	1	1	1	1	1	1	X	2	2	X	X	1	2	2	2	2	X	2
Mopar Brake Fluid	E0667-70	3	3	1	4	1	1	X	2	1	X	X	2	X	X	X	2	4	3
Morpholine	V1164-75	X	X	X	1	1	1	X	4	4	4	3	4	4	4	4	4	2	X
Motor Oils	N0674-70	1	1	4	1	1	1	X	2	4	1	1	4	4	4	4	2	1	2
Mustard Gas	E1267-80	X	X	X	X	1	1	X	X	X	X	X	X	X	X	X	X	X	X
Myristic Acid	V1164-75	X	X	X	1	1	1	X	4	4	4	3	4	4	4	4	4	2	X
- N -																			
Naphthalene	V1164-75	4	4	4	1	1	1	X	4	4	X	2	4	4	4	4	4	1	4
Naphthalene Chloride	V1164-75	X	X	X	1	1	1	X	4	4	4	3	4	4	4	4	4	2	X
Naphthalene Sulfonic Acid	V1164-75	X	X	X	1	1	1	X	4	4	4	3	4	4	4	4	4	2	X
Naphthalenic Acid	V1164-75	X	X	X	1	1	1	X	4	4	4	3	4	4	4	4	4	2	X
Naphthalonic Acid	V1164-75	X	X	X	1	1	1	X	4	4	4	3	4	4	4	4	4	2	X

Approximate Service Temperature Ranges for Commonly Used Basic Polymer Types*

Nitrile (General Service)	-34°C to 121°C (-30°F to 250°F)*	AFLAS	-9°C to 232°C (15°F to 450°F)*
Nitrile (Low Temperature)	-55°C to 107°C (-65°F to 225°F)*	Neoprene	-51°C to 107°C (-60°F to 225°F)*
Hydrogenated Nitrile	-32°C to 149°C (-23°F to 300°F)*	Polyacrylate	-21°C to 177°C (-5°F to 350°F)*
Ethylene Propylene	-57°C to 121°C (-70°F to 250°F)*	Polyurethane	-40°C to 82°C (-40°F to 180°F)*
Fluorocarbon	-26°C to 205°C (-15°F to 400°F)*	Butyl	-59°C to 120°C (-75°F to 250°F)*
Hifluor	-26°C to 205°C (-15°F to 400°F)*	Fluorosilicone	-73°C to 177°C (-100°F to 350°F)*
Perfluoroelastomer (Parofluor)	-26°C to 320°C (-15°F to 608°F)*	Silicone	-115°C to 232°C (-175°F to 450°F)*

NOTE: *These temperature ranges will apply to the majority of media for which the material is potentially recommended. With some media however, the service temperature range may be significantly different. ALWAYS TEST UNDER ACTUAL SERVICE CONDITIONS.

WARNING: These products can expose you to chemicals including carbon black (airborne and extracts), antimony trioxide, titanium dioxide, silica (crystalline), di(2-ethylhexyl) phthalate, ethylene thiourea, acrylonitrile, 1,3-butadiene, epichlorohydrin, toluenediisocyanate, tetrafluoroethylene, ethylbenzene, formaldehyde, furfuryl alcohol, glass fibers, methyl isobutyl ketone, nickel (metallic and compounds), lead and lead compounds which are known to the State of California to cause cancer; and 1,3-butadiene, epichlorohydrin, di(2-ethylhexyl)phthalate, di-isodecyl phthalate, ethylene thiourea, methyl isobutyl ketone, methanol, toluene, lead and lead compounds which are known to the State of California to cause birth defects and other reproductive harm. For more information go to www.P65Warnings.ca.gov.

COMPOUND COMPATIBILITY RATING
 1 - Satisfactory
 2 - Fair (usually OK for static seal)
 3 - Doubtful (sometimes OK for static seal)
 4 - Unsatisfactory
 x - Insufficient Data

	Recommended	Nitrile NBR	Hydrogenated Nitrile HNBR	Ethylene Propylene EPDM	Fluorocarbon FKM	Hifluor FKM	Perfluoroelastomer FFKM	Aflas (TFE/Propylene) FFKM	Neoprene/Chloroprene CR	Styrene-Butadiene SBR	Polyacrylate ACM	Polyurethane AU, EU	Butyl IIR	Butadiene BR	Isoprene IR	Natural Rubber NR	Hypalon CSM	Fluorosilicone FVMQ	Silicone MQ, VMQ, PVMQ
Naphthenic Acid	V1164-75	2	2	4	1	1	1	X	4	4	X	X	4	4	4	4	4	1	4
Naphthylamine	V3819-75	X	X	X	X	1	1	X	X	X	X	X	X	X	X	X	X	X	X
Naptha	V1164-75	2	2	4	1	1	1	X	4	4	2	2	4	4	4	4	4	2	4
Natural Gas	N0674-70	1	1	4	1	1	1	X	1	2	2	2	4	2	2	2	1	3	4
Neatsfoot Oil	N0674-70	1	1	2	1	1	1	X	4	4	1	1	2	4	4	4	4	1	2
Neon	B0612-70	1	1	1	1	1	1	X	1	1	1	1	1	1	1	1	1	1	1
Neville Acid	V1164-75	4	4	2	1	1	1	X	4	4	4	X	2	4	4	4	4	2	4
Nickel Acetate	E0540-80	2	2	1	4	1	1	X	2	4	4	4	1	4	1	1	4	4	4
Nickel Ammonium Sulfate	E0540-80	3	3	1	3	1	1	X	1	1	4	4	1	1	1	1	1	1	2
Nickel Chloride	N0674-70	1	1	1	1	1	1	X	2	1	3	3	1	1	1	1	1	1	1
Nickel Cyanide	E0540-80	3	3	1	3	1	1	X	1	1	4	4	1	1	1	1	1	1	2
Nickel Nitrate	E0540-80	3	3	1	3	1	1	X	1	1	4	4	1	1	1	1	1	1	2
Nickel Salts	N0674-70	1	1	1	1	1	1	X	2	1	3	3	1	1	1	1	1	1	1
Nickel Sulfate	N0674-70	1	1	1	1	1	1	X	1	2	4	3	1	2	2	2	1	1	1
Nicotinamide (Niacinamide)	V1164-75	X	X	X	1	1	1	X	4	4	4	3	4	4	4	4	4	2	X
Nicotinamide Hydrochloride	E0540-80	3	3	1	3	1	1	X	1	1	4	4	1	1	1	1	1	1	2
Nicotine	V1164-75	X	X	X	1	1	1	X	4	4	4	3	4	4	4	4	4	2	X
Nicotine Sulfate	E0540-80	3	3	1	3	1	1	X	1	1	4	4	1	1	1	1	1	1	2
Niter Cake	N0674-70	1	1	1	1	1	1	X	1	1	4	1	1	1	1	1	1	1	1
Nitric Acid, Red Fuming	V3819-75	4	4	4	2	1	1	3	4	X	X	X	X	X	X	X	X	X	X
Nitric Acid, White Fuming	V3819-75	X	X	X	X	2	2	X	X	X	X	X	X	X	X	X	X	X	X
Nitric Acid (0 - 50%)	V1164-75	4	X	2	1	1	1	X	X	X	X	X	X	X	X	X	X	X	X
Nitric Acid (50 - 100%)	V3819-75	4	X	4	3	1	1	X	X	X	X	X	X	X	X	X	X	X	X
Nitric Acid 3 Molar to 158°F	E0540-80	4	4	2	3	2	2	X	4	3	4	4	2	X	X	X	2	4	4
Nitric Acid Concentrated Room Temp.	V0834-70	X	X	4	2	1	1	X	X	X	X	X	X	X	X	X	X	X	X
Nitric Acid Concentrated to 158°F	V3819-75	4	4	4	4	3	2	X	4	4	4	4	4	X	X	4	X	4	4
Nitric Oxide	E0540-80	3	X	3	3	X	X	X	3	X	X	4	4	X	X	X	X	X	4
Nitroaniline	E0540-80	3	3	1	3	1	1	X	1	1	4	4	1	1	1	1	1	1	2
Nitrobenzene	E0540-80	4	4	1	2	1	1	X	4	4	4	4	1	4	4	4	4	4	4
Nitrobenzoic Acid	E0540-80	3	3	1	3	1	1	X	1	1	4	4	1	1	1	1	1	1	2
Nitrocellulose	E0540-80	3	3	1	3	1	1	X	1	1	4	4	1	1	1	1	1	1	2
Nitrochlorobenzene	E0540-80	3	3	1	3	1	1	X	1	1	4	4	1	1	1	1	1	1	2
Nitrochloroform	E0540-80	3	3	1	3	1	1	X	1	1	4	4	1	1	1	1	1	1	2
Nitrodiethylaniline	E0540-80	3	3	1	3	1	1	X	1	1	4	4	1	1	1	1	1	1	2
Nitrodiphenyl Ether	V3819-75	X	X	X	X	1	1	X	X	X	X	X	X	X	X	X	X	X	X
Nitroethane	E0540-80	4	4	2	4	1	1	X	2	2	4	4	2	2	2	2	2	4	4
Nitrofluorobenzene	E0540-80	3	3	1	3	1	1	X	1	1	4	4	1	1	1	1	1	1	2
Nitrogen	B0612-70	1	1	1	1	1	1	X	1	1	1	1	1	1	1	1	1	1	1
Nitrogen Dioxide	E0540-80	3	3	1	4	1	1	X	1	X	4	3	2	X	X	X	X	1	2
Nitrogen Oxides	E0540-80	3	3	1	3	1	1	X	1	1	4	4	1	1	1	1	1	1	2

Approximate Service Temperature Ranges for Commonly Used Basic Polymer Types*

Nitrile (General Service)	-34°C to 121°C (-30°F to 250°F)*	AFLAS	-9°C to 232°C (15°F to 450°F)*
Nitrile (Low Temperature)	-55°C to 107°C (-65°F to 225°F)*	Neoprene	-51°C to 107°C (-60°F to 225°F)*
Hydrogenated Nitrile	-32°C to 149°C (-23°F to 300°F)*	Polyacrylate	-21°C to 177°C (-5°F to 350°F)*
Ethylene Propylene	-57°C to 121°C (-70°F to 250°F)*	Polyurethane	-40°C to 82°C (-40°F to 180°F)*
Fluorocarbon	-26°C to 205°C (-15°F to 400°F)*	Butyl	-59°C to 120°C (-75°F to 250°F)*
Hifluor	-26°C to 205°C (-15°F to 400°F)*	Fluorosilicone	-73°C to 177°C (-100°F to 350°F)*
Perfluoroelastomer (Parofluor)	-26°C to 320°C (-15°F to 608°F)*	Silicone	-115°C to 232°C (-175°F to 450°F)*

NOTE: *These temperature ranges will apply to the majority of media for which the material is potentially recommended. With some media however, the service temperature range may be significantly different. ALWAYS TEST UNDER ACTUAL SERVICE CONDITIONS.

WARNING: These products can expose you to chemicals including carbon black (airborne and extracts), antimony trioxide, titanium dioxide, silica (crystalline), di(2-ethylhexyl) phthalate, ethylene thiourea, acrylonitrile, 1,3-butadiene, epichlorohydrin, toluenediisocyanate, tetrafluoroethylene, ethylbenzene, formaldehyde, furfuryl alcohol, glass fibers, methyl isobutyl ketone, nickel (metallic and compounds), lead and lead compounds which are known to the State of California to cause cancer; and 1,3-butadiene, epichlorohydrin, di(2-ethylhexyl)phthalate, di-isodecyl phthalate, ethylene thiourea, methyl isobutyl ketone, methanol, toluene, lead and lead compounds which are known to the State of California to cause birth defects and other reproductive harm. For more information go to www.P65Warnings.ca.gov.

COMPOUND COMPATIBILITY RATING
 1 - Satisfactory
 2 - Fair (usually OK for static seal)
 3 - Doubtful (sometimes OK for static seal)
 4 - Unsatisfactory
 x - Insufficient Data

	Recommended	Nitrile NBR	Hydrogenated Nitrile HNBR	Ethylene Propylene EPDM	Fluorocarbon FKM	Hifluor FKM	Perfluoroelastomer FFKM	Aflas (TFE/Propylene) FEPDM	Neoprene/Chloroprene CR	Styrene-Butadiene SBR	Polyacrylate ACM	Polyurethane AU, EU	Butyl IIR	Butadiene BR	Isoprene IR	Natural Rubber NR	Hypalon CSM	Fluorosilicone FVMQ	Silicone MQ, VMQ, PVMQ
Nitrogen Tetroxide (N2O4)	Factory	4	3	4	4	2	2	X	4	4	4	4	3	4	4	4	4	4	4
Nitrogen Trifluoride	V3819-75	X	X	X	X	2	2	X	X	X	X	X	X	X	X	X	X	X	X
Nitroglycerine	E0540-80	3	3	1	3	1	1	X	1	1	4	4	1	1	1	1	1	1	2
Nitroglycerol	E0540-80	3	3	1	3	1	1	X	1	1	4	4	1	1	1	1	1	1	2
Nitroisopropylbenzene	E0540-80	3	3	1	3	1	1	X	1	1	4	4	1	1	1	1	1	1	2
Nitromethane	E0540-80	4	4	2	4	1	1	X	3	3	4	4	2	2	2	2	2	4	4
Nitrophenol	E0540-80	3	3	1	3	1	1	X	1	1	4	4	1	1	1	1	1	1	2
Nitropropane	E0540-80	4	4	2	4	1	1	X	4	4	4	4	2	4	4	4	4	4	4
Nitrosyl Chloride	V3819-75	X	X	X	X	1	1	X	X	X	X	X	X	X	X	X	X	X	X
Nitrosylsulfuric Acid	V3819-75	X	X	X	X	1	1	X	X	X	X	X	X	X	X	X	X	X	X
Nitrothiophene	E0540-80	3	3	1	3	1	1	X	1	1	4	4	1	1	1	1	1	1	2
Nitrotoluene	E0540-80	3	3	1	3	1	1	X	1	1	4	4	1	1	1	1	1	1	2
Nitrous Acid	E0540-80	3	3	1	3	1	1	X	1	1	4	4	1	1	1	1	1	1	2
Nitrous Oxide	E0540-80	1	1	1	1	1	1	X	X	X	X	X	X	X	X	X	X	X	1
Nonane	N0674-70	1	1	4	1	1	1	X	2	4	1	1	4	4	4	4	2	1	2
Nonylphenoxy Polyethoxy Ethanol		X	X	X	X	X	X	X	X	X	X	X	X	X	X	X	X	X	X
Noryl GE Phenolic	N0674-70	1	1	1	X	X	X	X	X	X	X	X	X	X	X	X	X	X	X
Nyvac FR200 Mobil	N0674-70	1	1	1	1	1	1	X	2	4	X	X	4	4	X	4	3	X	X
- O -																			
Octachloro Toluene	V1164-75	4	4	4	1	1	1	X	4	4	4	4	4	4	4	4	4	2	4
Octadecane	N0674-70	1	1	4	1	1	1	X	2	4	2	1	4	4	4	4	2	1	4
Octanal (n-Octanaldehyde)	N0674-70	1	1	4	1	1	1	X	2	4	1	1	4	4	4	4	2	1	2
Octane or n-Octane	V1164-75	1	1	4	1	1	1	X	4	4	4	4	4	4	4	4	4	2	4
Octyl Acetate	E0540-80	3	3	1	3	1	1	X	1	1	4	4	1	1	1	1	1	1	2
Octyl Alcohol	V1164-75	2	2	3	1	1	1	X	2	2	4	4	2	2	2	2	2	2	2
Octyl Chloride	N0674-70	1	1	4	1	1	1	X	2	4	1	1	4	4	4	4	2	1	2
Octyl Phthalate	V1164-75	X	X	X	1	1	1	X	4	4	4	3	4	4	4	4	4	2	X
Olefins	V1164-75	X	X	X	1	1	1	X	4	4	4	3	4	4	4	4	4	2	X
Oleic Acid	V0834-70	3	3	4	2	1	1	X	4	4	4	2	4	4	4	4	4	X	4
Oleum (Fuming Sulfuric Acid)	V1164-75	4	4	4	1	1	1	X	4	4	4	4	4	4	4	4	4	X	4
Oleum Spirits	V1164-75	2	2	4	1	1	1	X	3	4	X	3	4	4	4	4	2	2	4
Oleyl Alcohol	V1164-75	X	X	X	1	1	1	X	4	4	4	3	4	4	4	4	4	2	X
Olive Oil	N0674-70	1	1	2	1	1	1	X	2	4	1	1	2	4	4	4	2	1	3
Oronite 8200	V1164-75	2	2	4	1	1	1	X	1	4	X	1	4	4	4	4	4	1	4
Oronite 8515	V1164-75	2	2	4	1	1	1	X	1	4	X	1	4	4	4	4	4	1	4
Ortho-Chloro Ethyl Benzene	V1164-75	4	4	4	1	1	1	X	4	4	4	4	4	4	4	4	4	2	4
Ortho-Chloroaniline	E0540-80	3	3	1	3	1	1	X	1	1	4	4	1	1	1	1	1	1	2
Ortho-Chlorophenol	E0540-80	3	3	1	3	1	1	X	1	1	4	4	1	1	1	1	1	1	2
Ortho-Cresol	E0540-80	3	3	1	3	1	1	X	1	1	4	4	1	1	1	1	1	1	2

Approximate Service Temperature Ranges for Commonly Used Basic Polymer Types*

Nitrile (General Service)	-34°C to 121°C (-30°F to 250°F)*	AFLAS	-9°C to 232°C (15°F to 450°F)*
Nitrile (Low Temperature)	-55°C to 107°C (-65°F to 225°F)*	Neoprene	-51°C to 107°C (-60°F to 225°F)*
Hydrogenated Nitrile	-32°C to 149°C (-23°F to 300°F)*	Polyacrylate	-21°C to 177°C (-5°F to 350°F)*
Ethylene Propylene	-57°C to 121°C (-70°F to 250°F)*	Polyurethane	-40°C to 82°C (-40°F to 180°F)*
Fluorocarbon	-26°C to 205°C (-15°F to 400°F)*	Butyl	-59°C to 120°C (-75°F to 250°F)*
Hifluor	-26°C to 205°C (-15°F to 400°F)*	Fluorosilicone	-73°C to 177°C (-100°F to 350°F)*
Perfluoroelastomer (Parofluor)	-26°C to 320°C (-15°F to 608°F)*	Silicone	-115°C to 232°C (-175°F to 450°F)*

NOTE: *These temperature ranges will apply to the majority of media for which the material is potentially recommended. With some media however, the service temperature range may be significantly different. ALWAYS TEST UNDER ACTUAL SERVICE CONDITIONS.

WARNING: These products can expose you to chemicals including carbon black (airborne and extracts), antimony trioxide, titanium dioxide, silica (crystalline), di(2-ethylhexyl) phthalate, ethylene thiourea, acrylonitrile, 1,3-butadiene, epichlorohydrin, toluenediisocyanate, tetrafluoroethylene, ethylbenzene, formaldehyde, furfuryl alcohol, glass fibers, methyl isobutyl ketone, nickel (metallic and compounds), lead and lead compounds which are known to the State of California to cause cancer; and 1,3-butadiene, epichlorohydrin, di(2-ethylhexyl)phthalate, di-isodecyl phthalate, ethylene thiourea, methyl isobutyl ketone, methanol, toluene, lead and lead compounds which are known to the State of California to cause birth defects and other reproductive harm. For more information go to www.P65Warnings.ca.gov.

Compatibility Tables for Gases, Fluids, Solids

COMPOUND COMPATIBILITY RATING
 1 - Satisfactory
 2 - Fair (usually OK for static seal)
 3 - Doubtful (sometimes OK for static seal)
 4 - Unsatisfactory
 x - Insufficient Data

	Recommended	Nitrile NBR	Hydrogenated Nitrile HNBR	Ethylene Propylene EPDM	Fluorocarbon FKM	Hifluor FKM	Perfluoroelastomer FFKM	Aflas (TFE/Propylene) FFKM	Neoprene/Chloroprene CR	Styrene-Butadiene SBR	Polyacrylate ACM	Polyurethane AU, EU	Butyl IIR	Butadiene BR	Isoprene IR	Natural Rubber NR	Hypalon CSM	Fluorosilicone FVMQ	Silicone MQ, VMQ, PVMQ
Ortho-Dichlorobenzene	V1164-75	4	4	4	1	1	1	X	4	4	4	4	4	4	4	4	4	2	4
Ortho-Nitrotoluene	E0540-80	3	3	1	3	1	1	X	1	1	4	4	1	1	1	1	1	1	2
Orthophos Acid	V3819-75	X	X	X	X	1	1	X	X	X	X	X	X	X	X	X	X	X	X
OS 45 Type III (OS45)	V1164-75	2	2	4	1	1	1	X	1	4	X	4	4	4	4	4	2	2	4
OS 45 Type IV (OS45-1)	V1164-75	2	2	4	1	1	1	X	1	4	X	4	4	4	4	4	2	2	4
OS 70	V1164-75	2	2	4	1	1	1	X	1	4	X	4	4	4	4	4	2	2	4
Oxalic Acid	E0540-80	2	2	1	1	1	1	X	2	2	X	X	1	2	2	2	2	1	2
Oxygen, 200°-300°F (Evalute for specific applications)	V1164-75	4	4	4	2	1	1	1	3	4	1	X	1	X	X	4	X	1	1
Oxygen, 300°-400°F (Evalute for specific applications)	S0604-70	4	4	4	2	1	1	X	4	4	4	4	4	4	4	4	4	4	1
Oxygen, Cold (Evalute for specific applications)	C0873-70	2	2	1	1	1	1	X	1	2	2	1	1	2	2	2	1	1	1
Oxygen, Liquid	V3819-75	4	4	4	4	3	2	4	4	X	X	X	X	X	X	X	X	X	X
Ozonated Deionized Water	E0540-80	3	3	1	3	2	2	X	1	1	4	4	1	1	1	1	1	1	2
Ozone	E0540-80	4	2	1	1	1	1	X	2	4	2	1	2	4	4	4	1	1	1
- P -																			
PAG Compressor Oil	N1173-70	X	X	X	X	X	X	X	X	X	X	X	X	X	X	X	X	X	X
Paint Thinner, Duco	V1164-75	4	4	4	2	1	1	X	4	4	4	4	4	4	4	4	4	2	4
Palmitic Acid	N0674-70	1	1	2	1	1	1	X	2	2	X	1	2	2	2	2	3	1	4
PAO	V1164-75	X	X	X	X	X	X	X	X	X	X	X	X	X	X	X	X	X	X
Para-Aminobenzoic Acid	E0540-80	3	3	1	3	1	1	X	1	1	4	4	1	1	1	1	1	1	2
Para-Aminosalicylic Acid	E0540-80	3	3	1	3	1	1	X	1	1	4	4	1	1	1	1	1	1	2
Para-Bromobenzylphenyl Ether	V3819-75	X	X	X	X	1	1	X	X	X	X	X	X	X	X	X	X	X	X
Para-Chlorophenol	E0540-80	3	3	1	3	1	1	X	1	1	4	4	1	1	1	1	1	1	2
Paracymene	V1164-75	X	X	X	1	1	1	X	4	4	4	3	4	4	4	4	4	2	X
Para-Dichlorobenzene	V1164-75	4	4	4	1	1	1	X	4	4	4	4	4	4	4	4	4	2	4
Paraffins	N0674-70	1	1	4	1	1	1	X	2	4	1	1	4	4	4	4	2	1	2
Para-Formaldehyde	E0540-80	3	3	1	3	1	1	X	1	1	4	4	1	1	1	1	1	1	2
Paraldehyde	E0540-80	3	3	1	3	1	1	X	1	1	4	4	1	1	1	1	1	1	2
Par-al-Ketone	Factory	4	4	4	4	X	X	X	4	4	4	4	4	4	4	4	4	4	4
Para-Nitroaniline	E0540-80	3	3	1	3	1	1	X	1	1	4	4	1	1	1	1	1	1	2
Para-Nitrobenzoic Acid	E0540-80	3	3	1	3	1	1	X	1	1	4	4	1	1	1	1	1	1	2
Para-Nitrophenol	E0540-80	3	3	1	3	1	1	X	1	1	4	4	1	1	1	1	1	1	2
Parathion	V1164-75	X	X	X	1	1	1	X	4	4	4	3	4	4	4	4	4	2	X
Para-Toluene Sulfonic Acid	E0540-80	3	3	1	3	1	1	X	1	1	4	4	1	1	1	1	1	1	2
Paraxylene	V1164-75	X	X	X	X	X	X	X	X	X	X	X	X	X	X	X	X	X	X
Parker O Lube	N0674-70	1	1	4	1	1	1	X	1	2	1	1	4	4	4	4	1	1	2
Peanut Oil	N0674-70	1	1	3	1	1	1	X	3	4	1	2	3	4	4	4	2	1	1
Pectin (Liquor)	V1164-75	X	X	X	1	1	1	X	4	4	4	3	4	4	4	4	2	X	
Pelagonic Acid	V3819-75	X	X	X	X	1	1	X	X	X	X	X	X	X	X	X	X	X	X
Penicillin (Liquid)	V1164-75	X	X	X	1	1	1	X	4	4	4	3	4	4	4	4	4	2	X

Approximate Service Temperature Ranges for Commonly Used Basic Polymer Types*

Nitrile (General Service)	-34°C to 121°C (-30°F to 250°F)*	AFLAS	-9°C to 232°C (15°F to 450°F)*
Nitrile (Low Temperature)	-55°C to 107°C (-65°F to 225°F)*	Neoprene	-51°C to 107°C (-60°F to 225°F)*
Hydrogenated Nitrile	-32°C to 149°C (-23°F to 300°F)*	Polyacrylate	-21°C to 177°C (-5°F to 350°F)*
Ethylene Propylene	-57°C to 121°C (-70°F to 250°F)*	Polyurethane	-40°C to 82°C (-40°F to 180°F)*
Fluorocarbon	-26°C to 205°C (-15°F to 400°F)*	Butyl	-59°C to 120°C (-75°F to 250°F)*
Hifluor	-26°C to 205°C (-15°F to 400°F)*	Fluorosilicone	-73°C to 177°C (-100°F to 350°F)*
Perfluoroelastomer (Parofluor)	-26°C to 320°C (-15°F to 608°F)*	Silicone	-115°C to 232°C (-175°F to 450°F)*

NOTE: *These temperature ranges will apply to the majority of media for which the material is potentially recommended. With some media however, the service temperature range may be significantly different. ALWAYS TEST UNDER ACTUAL SERVICE CONDITIONS.

WARNING: These products can expose you to chemicals including carbon black (airborne and extracts), antimony trioxide, titanium dioxide, silica (crystalline), di(2-ethylhexyl) phthalate, ethylene thiourea, acrylonitrile, 1,3-butadiene, epichlorohydrin, toluenediisocyanate, tetrafluoroethylene, ethylbenzene, formaldehyde, furfuryl alcohol, glass fibers, methyl isobutyl ketone, nickel (metallic and compounds), lead and lead compounds which are known to the State of California to cause cancer; and 1,3-butadiene, epichlorohydrin, di(2-ethylhexyl)phthalate, di-isodecyl phthalate, ethylene thiourea, methyl isobutyl ketone, methanol, toluene, lead and lead compounds which are known to the State of California to cause birth defects and other reproductive harm. For more information go to www.P65Warnings.ca.gov.

COMPOUND COMPATIBILITY RATING
 1 - Satisfactory
 2 - Fair (usually OK for static seal)
 3 - Doubtful (sometimes OK for static seal)
 4 - Unsatisfactory
 x - Insufficient Data

	Recommended	Nitrile NBR	Hydrogenated Nitrile HNBR	Ethylene Propylene EPDM	Fluorocarbon FKM	Hifluor FKM	Perfluoroelastomer FFKM	Aflas (TFE/Propylene) FFKM	Neoprene/Chloroprene CR	Styrene-Butadiene SBR	Polyacrylate ACM	Polyurethane AU, EU	Butyl IIR	Butadiene BR	Isoprene IR	Natural Rubber NR	Hypalon CSM	Fluorosilicone FVMQ	Silicone MQ, VMQ, PVMQ
Pentachloroethane	V1164-75	X	X	X	1	1	1	X	4	4	4	3	4	4	4	4	4	2	X
Pentachlorophenol	E0540-80	3	3	1	3	1	1	X	1	1	4	4	1	1	1	1	1	1	2
Pentaerythritol	E0540-80	3	3	1	3	1	1	X	1	1	4	4	1	1	1	1	1	1	2
Pentaerythritol Tetranitrate	E0540-80	3	3	1	3	1	1	X	1	1	4	4	1	1	1	1	1	1	2
Pentafluoroethane (F-125)	V3819-75	X	X	X	X	2	2	X	X	X	X	X	X	X	X	X	X	X	X
Pentane or n-Pentane	N0674-70	1	1	4	1	1	1	X	1	3	1	4	4	4	4	4	2	3	4
Pentane, 2 Methyl	N0674-70	1	1	4	1	1	1	X	2	4	1	4	4	4	4	4	2	3	4
Pentane, 2-4 dimethyl	N0674-70	1	1	4	1	1	1	X	2	4	1	4	4	4	4	4	2	3	4
Pentane, 3-Methyl	N0674-70	1	1	4	1	1	1	X	2	4	1	4	4	4	4	4	2	3	4
Pentoxone	V3819-75	X	X	X	X	1	1	X	X	X	X	X	X	X	X	X	X	X	X
Pentyl Pentanoate	N0674-70	1	1	4	1	1	1	X	2	4	1	1	4	4	4	4	2	1	2
Peracetic Acid	E0540-80	3	3	1	3	1	1	X	1	1	4	4	1	1	1	1	1	1	2
Perchloric Acid - 2N	E0540-80	4	4	1	1	1	1	X	2	4	4	4	2	4	4	4	2	1	2
Perchloroethylene	V1164-75	2	2	4	1	1	1	X	4	4	4	4	4	4	4	4	4	2	4
Perfluoropropane	V3819-75	X	X	X	X	2	2	X	X	X	X	X	X	X	X	X	X	X	X
Perfluorotriethylamine	V3819-75	X	X	X	X	2	2	X	X	X	X	X	X	X	X	X	X	X	X
Permanganic Acid	FF200-75	X	X	X	X	1	1	X	X	X	X	X	X	X	X	X	X	X	X
Persulfuric Acid (Caro's Acid)	V3819-75	X	X	X	X	1	1	X	X	X	X	X	X	X	X	X	X	X	X
Petrolatum	N0674-70	1	1	4	1	1	1	X	2	4	1	1	4	4	4	4	2	1	4
Petrolatum Ether	N0674-70	1	1	4	1	1	1	X	2	4	1	1	4	4	4	4	2	1	2
Petroleum Oil, Above 250°F	V1164-75	4	4	4	2	1	1	X	4	4	4	4	4	4	4	4	4	4	4
Petroleum Oil, Below 250°F	N0674-70	1	1	4	1	1	1	X	2	4	2	2	4	4	4	4	2	2	2
Petroleum Oil, Crude	N0674-70	1	1	4	1	1	1	X	2	4	1	1	4	4	4	4	2	1	4
Phenol	V1164-75	4	4	4	1	1	1	X	4	4	4	4	4	4	4	4	4	2	4
Phenol, 70% / 30% H2O	V1164-75	4	4	4	1	1	1	X	4	4	4	4	4	4	4	4	4	2	4
Phenol, 85% / 15% H2O	V1164-75	4	4	4	1	1	1	X	4	4	4	4	4	4	4	4	4	2	4
Phenolic Sulfonate	E0540-80	3	3	1	3	1	1	X	1	1	4	4	1	1	1	1	1	1	2
Phenolsulfonic Acid	E0540-80	3	3	1	3	1	1	X	1	1	4	4	1	1	1	1	1	1	2
Phenylacetamide	V1164-75	X	X	X	1	1	1	X	4	4	4	3	4	4	4	4	4	2	X
Phenylacetate	E0540-80	3	3	1	3	1	1	X	1	1	4	4	1	1	1	1	1	1	2
Phenylacetic Acid	E0540-80	3	3	1	3	1	1	X	1	1	4	4	1	1	1	1	1	1	2
Phenylbenzene	V1164-75	4	4	4	1	1	1	X	4	4	4	4	4	4	4	4	4	2	4
Phenylene Diamine	FF500-75	X	X	X	X	1	1	X	X	X	X	X	X	X	X	X	X	X	X
Phenylethyl Alcohol	V1164-75	X	X	X	1	1	1	X	4	4	4	3	4	4	4	4	4	2	X
Phenylethyl Ether	FF200-75	4	4	4	1	1	1	X	4	4	4	4	4	4	4	4	4	4	4
Phenylethyl Malonic Ester*	V1164-75	X	X	X	1	1	1	X	4	4	4	3	4	4	4	4	4	2	X
Phenylglycerine	E0540-80	3	3	1	3	1	1	X	1	1	4	4	1	1	1	1	1	1	2
Phenylhydrazine	V1164-75	4	4	2	1	1	1	X	4	2	4	X	4	2	1	1	4	X	X
Phenylhydrazine Hydrochloride	E0540-80	3	3	1	3	1	1	X	1	1	4	4	1	1	1	1	1	1	2
Phenylmercuric Acetate	E0540-80	3	3	1	3	1	1	X	1	1	4	4	1	1	1	1	1	1	2

Approximate Service Temperature Ranges for Commonly Used Basic Polymer Types*

Nitrile (General Service)	-34°C to 121°C (-30°F to 250°F)*	AFLAS	-9°C to 232°C (15°F to 450°F)*
Nitrile (Low Temperature)	-55°C to 107°C (-65°F to 225°F)*	Neoprene	-51°C to 107°C (-60°F to 225°F)*
Hydrogenated Nitrile	-32°C to 149°C (-23°F to 300°F)*	Polyacrylate	-21°C to 177°C (-5°F to 350°F)*
Ethylene Propylene	-57°C to 121°C (-70°F to 250°F)*	Polyurethane	-40°C to 82°C (-40°F to 180°F)*
Fluorocarbon	-26°C to 205°C (-15°F to 400°F)*	Butyl	-59°C to 120°C (-75°F to 250°F)*
Hifluor	-26°C to 205°C (-15°F to 400°F)*	Fluorosilicone	-73°C to 177°C (-100°F to 350°F)*
Perfluoroelastomer (Parofluor)	-26°C to 320°C (-15°F to 608°F)*	Silicone	-115°C to 232°C (-175°F to 450°F)*

NOTE: *These temperature ranges will apply to the majority of media for which the material is potentially recommended. With some media however, the service temperature range may be significantly different. ALWAYS TEST UNDER ACTUAL SERVICE CONDITIONS.

WARNING: These products can expose you to chemicals including carbon black (airborne and extracts), antimony trioxide, titanium dioxide, silica (crystalline), di(2-ethylhexyl) phthalate, ethylene thiourea, acrylonitrile, 1,3-butadiene, epichlorohydrin, toluenediisocyanate, tetrafluoroethylene, ethylbenzene, formaldehyde, furfuryl alcohol, glass fibers, methyl isobutyl ketone, nickel (metallic and compounds), lead and lead compounds which are known to the State of California to cause cancer; and 1,3-butadiene, epichlorohydrin, di(2-ethylhexyl)phthalate, di-isodecyl phthalate, ethylene thiourea, methyl isobutyl ketone, methanol, toluene, lead and lead compounds which are known to the State of California to cause birth defects and other reproductive harm. For more information go to www.P65Warnings.ca.gov.

Compatibility Tables for Gases, Fluids, Solids

COMPOUND COMPATIBILITY RATING
 1 - Satisfactory
 2 - Fair (usually OK for static seal)
 3 - Doubtful (sometimes OK for static seal)
 4 - Unsatisfactory
 x - Insufficient Data

	Recommended	Nitrile NBR	Hydrogenated Nitrile HNBR	Ethylene Propylene EPDM	Fluorocarbon FKM	Hifluor FKM	Perfluoroelastomer FFKM	Aflas (TFE/Propylene) FEPDM	Neoprene/Chloroprene CR	Styrene-Butadiene SBR	Polyacrylate ACM	Polyurethane AU, EU	Butyl IIR	Butadiene BR	Isoprene IR	Natural Rubber NR	Hypalon CSM	Fluorosilicone FVMQ	Silicone MQ, VMQ, PVMQ
Phorone	Factory	4	4	3	4	1	1	X	4	4	4	4	3	4	4	4	4	4	4
Phosgene	V3819-75	X	X	X	X	1	1	X	X	X	X	X	X	X	X	X	X	X	X
Phosphine	V3819-75	X	X	X	X	1	1	X	X	X	X	X	X	X	X	X	X	X	X
Phosphoric Acid 3 Molar to 158°F	E0540-80	1	1	1	1	1	1	X	2	2	3	4	1	X	X	X	1	2	2
Phosphoric Acid Concentrated Room Temp	E0540-80	2	2	1	1	1	1	X	2	1	2	4	1	X	X	X	1	3	3
Phosphoric Acid Concentrated to 158°F	E0540-80	4	4	1	1	1	1	X	3	2	3	4	1	X	X	X	1	3	4
Phosphoric Acid, 20%	E0540-80	X	X	X	X	1	1	X	X	X	X	X	X	X	X	X	X	X	X
Phosphoric Acid, 45%	V3819-75	X	X	X	X	1	1	X	X	X	X	X	X	X	X	X	X	X	X
Phosphorus (Molten)	V3819-75	X	X	X	X	1	1	X	X	X	X	X	X	X	X	X	X	X	X
Phosphorus Oxychloride	V3819-75	X	X	X	X	1	1	X	X	X	X	X	X	X	X	X	X	X	X
Phosphorus Trichloride	E0540-80	4	4	1	1	1	1	X	4	4	X	X	1	X	X	4	4	1	X
Phosphorus Trichloride Acid	E0540-80	4	4	1	1	1	1	1	4	X	X	X	X	X	X	X	X	X	X
Phthalic Acid	E0540-80	3	3	1	3	1	1	X	1	1	4	4	1	1	1	1	1	1	2
Phthalic Anhydride	E0540-80	3	3	1	3	1	1	X	1	1	4	4	1	1	1	1	1	1	2
Pickling Solution	V0834-70	4	4	3	2	1	1	X	4	4	4	4	3	4	4	4	2	4	4
Picric Acid (aq)	C0873-70	1	1	1	1	1	1	X	1	2	X	X	1	2	2	1	1	2	X
Picric Acid Molten	V0834-70	2	2	2	1	1	1	X	2	2	X	X	2	2	2	2	2	2	4
Pine Oil	N0674-70	1	1	4	1	1	1	X	4	4	X	X	4	4	4	4	4	1	4
Pine Tar	N0674-70	1	1	4	1	1	1	X	2	4	1	1	4	4	4	4	2	1	2
Pinene	V1164-75	2	2	4	1	1	1	X	3	4	4	2	4	4	4	4	4	1	4
Piperazine	V1164-75	X	X	X	1	1	1	X	4	4	4	3	4	4	4	4	4	2	X
Piperidine	V1164-75	4	4	4	1	1	1	X	4	4	4	3	4	4	4	4	4	2	4
Piranha (H2SO4:H2O2)(70:30)	V3819-75	X	X	X	X	1	1	X	X	X	X	X	X	X	X	X	X	X	X
Plating Solution (Co,Cu,Au,In,Fe,Pb,Ni,Ag,Sn,Zn)	N0674-70	1	1	1	1	1	1	1	X	X	X	X	X	X	X	X	X	X	X
Plating Solutions Chrome	V1164-75	4	4	2	1	1	1	X	4	4	4	4	2	4	4	4	4	2	2
Plating Solutions Others	E0540-80	1	1	1	1	1	1	X	4	4	X	X	1	X	X	4	1	X	4
Pneumatic Service	N0674-70	1	1	1	1	1	1	X	1	4	4	1	1	4	4	4	1	4	4
Polyetherpolyol		X	X	X	X	X	X	X	X	X	X	X	X	X	X	X	X	X	X
Polyethylene Glycol	E0540-80	2	2	1	3	1	1	1	2	X	X	X	X	X	X	X	X	X	X
Polyglycerol	E0540-80	3	3	1	3	1	1	X	1	1	4	4	1	1	1	1	1	1	2
Polyglycol	E0540-80	3	3	1	3	1	1	X	1	1	4	4	1	1	1	1	1	1	2
Polyolester (POE)	N1173-70	X	X	X	X	X	X	X	X	X	X	X	X	X	X	X	X	X	X
Polyvinyl Acetate Emulsion	E0540-80	X	X	1	X	1	1	X	2	4	X	X	1	X	X	2	2	X	X
Potassium (Molten)	V3819-75	X	X	X	X	4	4	X	X	X	X	X	X	X	X	X	X	X	X
Potassium Acetate	E0540-80	2	2	1	4	1	1	X	2	4	4	4	1	4	1	1	1	4	4
Potassium Acid Sulfate	E0540-80	3	3	1	3	1	1	X	1	1	4	4	1	1	1	1	1	1	2
Potassium Alum	E0540-80	3	3	1	3	1	1	X	1	1	4	4	1	1	1	1	1	1	2
Potassium Aluminum Sulfate	E0540-80	3	3	1	3	1	1	X	1	1	4	4	1	1	1	1	1	1	2
Potassium Antimonate	E0540-80	3	3	1	3	1	1	X	1	1	4	4	1	1	1	1	1	1	2
Potassium Bicarbonate	E0540-80	3	3	1	3	1	1	X	1	1	4	4	1	1	1	1	1	1	2

Approximate Service Temperature Ranges for Commonly Used Basic Polymer Types*

Nitrile (General Service)	-34°C to 121°C (-30°F to 250°F)*	AFLAS	-9°C to 232°C (15°F to 450°F)*
Nitrile (Low Temperature)	-55°C to 107°C (-65°F to 225°F)*	Neoprene	-51°C to 107°C (-60°F to 225°F)*
Hydrogenated Nitrile	-32°C to 149°C (-23°F to 300°F)*	Polyacrylate	-21°C to 177°C (-5°F to 350°F)*
Ethylene Propylene	-57°C to 121°C (-70°F to 250°F)*	Polyurethane	-40°C to 82°C (-40°F to 180°F)*
Fluorocarbon	-26°C to 205°C (-15°F to 400°F)*	Butyl	-59°C to 120°C (-75°F to 250°F)*
Hifluor	-26°C to 205°C (-15°F to 400°F)*	Fluorosilicone	-73°C to 177°C (-100°F to 350°F)*
Perfluoroelastomer (Parofluor)	-26°C to 320°C (-15°F to 608°F)*	Silicone	-115°C to 232°C (-175°F to 450°F)*

NOTE: *These temperature ranges will apply to the majority of media for which the material is potentially recommended. With some media however, the service temperature range may be significantly different. ALWAYS TEST UNDER ACTUAL SERVICE CONDITIONS.

WARNING: These products can expose you to chemicals including carbon black (airborne and extracts), antimony trioxide, titanium dioxide, silica (crystalline), di(2-ethylhexyl) phthalate, ethylene thiourea, acrylonitrile, 1,3-butadiene, epichlorohydrin, toluenediisocyanate, tetrafluoroethylene, ethylbenzene, formaldehyde, furfuryl alcohol, glass fibers, methyl isobutyl ketone, nickel (metallic and compounds), lead and lead compounds which are known to the State of California to cause cancer; and 1,3-butadiene, epichlorohydrin, di(2-ethylhexyl)phthalate, di-isodecyl phthalate, ethylene thiourea, methyl isobutyl ketone, methanol, toluene, lead and lead compounds which are known to the State of California to cause birth defects and other reproductive harm. For more information go to www.P65Warnings.ca.gov.

COMPOUND COMPATIBILITY RATING
 1 - Satisfactory
 2 - Fair (usually OK for static seal)
 3 - Doubtful (sometimes OK for static seal)
 4 - Unsatisfactory
 x - Insufficient Data

	Recommended	Nitrile NBR	Hydrogenated Nitrile HNBR	Ethylene Propylene EPDM	Fluorocarbon FKM	Hifluor FKM	Perfluoroelastomer FFKM	Aflas (TFE/Propylene) FEPDM	Neoprene/Chloroprene CR	Styrene-Butadiene SBR	Polyacrylate ACM	Polyurethane AU, EU	Butyl IIR	Butadiene BR	Isoprene IR	Natural Rubber NR	Hypalon CSM	Fluorosilicone FVMQ	Silicone MQ, VMQ, PVMQ
Potassium Bichromate	E0540-80	3	3	1	3	1	1	X	1	1	4	4	1	1	1	1	1	1	2
Potassium Bifluoride	E0540-80	3	3	1	3	1	1	X	1	1	4	4	1	1	1	1	1	1	2
Potassium Bisulfate	E0540-80	3	3	1	3	1	1	X	1	1	4	4	1	1	1	1	1	1	2
Potassium Bisulfite	E0540-80	3	3	1	3	1	1	X	1	1	4	4	1	1	1	1	1	1	2
Potassium Bitartrate	E0540-80	3	3	1	3	1	1	X	1	1	4	4	1	1	1	1	1	1	2
Potassium Bromide	E0540-80	3	3	1	3	1	1	X	1	1	4	4	1	1	1	1	1	1	2
Potassium Carbonate	E0540-80	3	3	1	3	1	1	X	1	1	4	4	1	1	1	1	1	1	2
Potassium Chlorate	E0540-80	3	3	1	3	1	1	X	1	1	4	4	1	1	1	1	1	1	2
Potassium Chloride	N0674-70	1	1	1	1	1	1	X	1	1	1	1	1	1	1	1	1	1	1
Potassium Chromates	E0540-80	3	3	1	3	1	1	X	1	1	4	4	1	1	1	1	1	1	2
Potassium Citrate	E0540-80	3	3	1	3	1	1	X	1	1	4	4	1	1	1	1	1	1	2
Potassium Cupro Cyanide	N0674-70	1	1	1	1	1	1	X	1	1	1	1	1	1	1	1	1	1	1
Potassium Cyanate	E0540-80	3	3	1	3	1	1	X	1	1	4	4	1	1	1	1	1	1	2
Potassium Cyanide	N0674-70	1	1	1	1	1	1	X	1	1	1	1	1	1	1	1	1	1	1
Potassium Dichromate	N0674-70	1	1	1	1	1	1	X	1	1	1	2	1	1	1	1	1	1	1
Potassium Diphosphate	E0540-80	3	3	1	3	1	1	X	1	1	4	4	1	1	1	1	1	1	2
Potassium Ferricyanide	E0540-80	3	3	1	3	1	1	X	1	1	4	4	1	1	1	1	1	1	2
Potassium Fluoride	E0540-80	3	3	1	3	1	1	X	1	1	4	4	1	1	1	1	1	1	2
Potassium Glucocyanate	E0540-80	3	3	1	3	1	1	X	1	1	4	4	1	1	1	1	1	1	2
Potassium Hydroxide 50%	E0540-80	2	2	1	4	1	1	X	2	2	4	4	1	2	2	2	1	3	3
Potassium Hypochlorite	E0540-80	3	3	1	3	1	1	X	1	1	4	4	1	1	1	1	1	1	2
Potassium Iodate	E0540-80	3	3	1	3	1	1	X	1	1	4	4	1	1	1	1	1	1	2
Potassium Iodide	E0540-80	3	3	1	3	1	1	X	1	1	4	4	1	1	1	1	1	1	2
Potassium Metabisulfate	E0540-80	3	3	1	3	1	1	X	1	1	4	4	1	1	1	1	1	1	2
Potassium Metachromate	E0540-80	3	3	1	3	1	1	X	1	1	4	4	1	1	1	1	1	1	2
Potassium Metasilicate	V3819-75	X	X	X	X	1	1	X	X	X	X	X	X	X	X	X	X	X	X
Potassium Monochromate	E0540-80	3	3	1	3	1	1	X	1	1	4	4	1	1	1	1	1	1	2
Potassium Nitrate	N0674-70	1	1	1	1	1	1	X	1	1	1	1	1	1	1	1	1	1	1
Potassium Nitrite	E0540-80	3	3	1	3	1	1	X	1	1	4	4	1	1	1	1	1	1	2
Potassium Oxalate	E0540-80	3	3	1	3	1	1	X	1	1	4	4	1	1	1	1	1	1	2
Potassium Perchlorate	E0540-80	3	3	1	3	1	1	X	1	1	4	4	1	1	1	1	1	1	2
Potassium Perfluoro Acetate	V3819-75	X	X	X	X	2	1	X	X	X	X	X	X	X	X	X	X	X	X
Potassium Permanganate	E0540-80	3	3	1	3	1	1	X	1	1	4	4	1	1	1	1	1	1	2
Potassium Peroxide	V3819-75	X	X	X	X	1	1	X	X	X	X	X	X	X	X	X	X	X	X
Potassium Persulfate	E0540-80	3	3	1	3	1	1	X	1	1	4	4	1	1	1	1	1	1	2
Potassium Phosphate (Acid)	E0540-80	3	3	1	3	1	1	X	1	1	4	4	1	1	1	1	1	1	2
Potassium Phosphate (Alkaline)	E0540-80	3	3	1	3	1	1	X	1	1	4	4	1	1	1	1	1	1	2
Potassium Phosphate (Di/Tri Basic)	E0540-80	3	3	1	3	1	1	X	1	1	4	4	1	1	1	1	1	1	2
Potassium Pyrosulfate	E0540-80	3	3	1	3	1	1	X	1	1	4	4	1	1	1	1	1	1	2
Potassium Salts	N0674-70	1	1	1	1	1	1	X	1	1	1	1	1	1	1	1	1	1	1

Approximate Service Temperature Ranges for Commonly Used Basic Polymer Types*

Nitrile (General Service)	-34°C to 121°C (-30°F to 250°F)*	AFLAS	-9°C to 232°C (15°F to 450°F)*
Nitrile (Low Temperature)	-55°C to 107°C (-65°F to 225°F)*	Neoprene	-51°C to 107°C (-60°F to 225°F)*
Hydrogenated Nitrile	-32°C to 149°C (-23°F to 300°F)*	Polyacrylate	-21°C to 177°C (-5°F to 350°F)*
Ethylene Propylene	-57°C to 121°C (-70°F to 250°F)*	Polyurethane	-40°C to 82°C (-40°F to 180°F)*
Fluorocarbon	-26°C to 205°C (-15°F to 400°F)*	Butyl	-59°C to 120°C (-75°F to 250°F)*
Hifluor	-26°C to 205°C (-15°F to 400°F)*	Fluorosilicone	-73°C to 177°C (-100°F to 350°F)*
Perfluoroelastomer (Parofluor)	-26°C to 320°C (-15°F to 608°F)*	Silicone	-115°C to 232°C (-175°F to 450°F)*

NOTE: *These temperature ranges will apply to the majority of media for which the material is potentially recommended. With some media however, the service temperature range may be significantly different. ALWAYS TEST UNDER ACTUAL SERVICE CONDITIONS.

WARNING: These products can expose you to chemicals including carbon black (airborne and extracts), antimony trioxide, titanium dioxide, silica (crystalline), di(2-ethylhexyl) phthalate, ethylene thiourea, acrylonitrile, 1,3-butadiene, epichlorohydrin, toluenediisocyanate, tetrafluoroethylene, ethylbenzene, formaldehyde, furfuryl alcohol, glass fibers, methyl isobutyl ketone, nickel (metallic and compounds), lead and lead compounds which are known to the State of California to cause cancer; and 1,3-butadiene, epichlorohydrin, di(2-ethylhexyl)phthalate, di-isodecyl phthalate, ethylene thiourea, methyl isobutyl ketone, methanol, toluene, lead and lead compounds which are known to the State of California to cause birth defects and other reproductive harm. For more information go to www.P65Warnings.ca.gov.

COMPOUND COMPATIBILITY RATING
 1 - Satisfactory
 2 - Fair (usually OK for static seal)
 3 - Doubtful (sometimes OK for static seal)
 4 - Unsatisfactory
 x - Insufficient Data

	Recommended	Nitrile NBR	Hydrogenated Nitrile HNBR	Ethylene Propylene EPDM	Fluorocarbon FKM	Hifluor FKM	Perfluoroelastomer FFKM	Aflas (TFE/Propylene) FFKM	Neoprene/Chloroprene CR	Styrene-Butadiene SBR	Polyacrylate ACM	Polyurethane AU, EU	Butyl IIR	Butadiene BR	Isoprene IR	Natural Rubber NR	Hypalon CSM	Fluorosilicone FVMQ	Silicone MQ, VMQ, PVMQ
Potassium Silicate	V3819-75	X	X	X	X	1	1	X	X	X	X	X	X	X	X	X	X	X	X
Potassium Sodium Tartrate	E0540-80	3	3	1	3	1	1	X	1	1	4	4	1	1	1	1	1	1	2
Potassium Stannate	E0540-80	3	3	1	3	1	1	X	1	1	4	4	1	1	1	1	1	1	2
Potassium Stearate	E0540-80	3	3	1	3	1	1	X	1	1	4	4	1	1	1	1	1	1	2
Potassium Sulfate	N0674-70	1	1	1	1	1	1	X	1	2	4	1	1	1	2	2	2	1	1
Potassium Sulfide	E0540-80	3	3	1	3	1	1	X	1	1	4	4	1	1	1	1	1	1	2
Potassium Sulfite	N0674-70	1	1	1	1	1	1	X	1	2	4	1	1	1	2	2	2	1	1
Potassium Tartrate	E0540-80	3	3	1	3	1	1	X	1	1	4	4	1	1	1	1	1	1	2
Potassium Thiocyanate	E0540-80	3	3	1	3	1	1	X	1	1	4	4	1	1	1	1	1	1	2
Potassium Thiosulfate	E0540-80	3	3	1	3	1	1	X	1	1	4	4	1	1	1	1	1	1	2
Potassium Triphosphate	E0540-80	3	3	1	3	1	1	X	1	1	4	4	1	1	1	1	1	1	2
Prestone Antifreeze	N0674-70	1	1	1	1	1	1	X	1	1	4	4	1	1	1	1	1	1	1
PRL-High Temp. Hydr. Oil	V1164-75	2	2	4	1	1	1	X	2	4	1	2	4	4	4	4	4	1	2
Producer Gas	N0674-70	1	1	4	1	1	1	X	2	4	2	1	4	4	4	4	2	2	2
Propane	N0674-70	1	1	4	1	1	1	X	2	4	1	3	4	4	4	4	2	2	4
Propionaldehyde	E0540-80	3	3	1	3	1	1	X	1	1	4	4	1	1	1	1	1	1	2
Propionic Acid	E0540-80	3	3	1	3	1	1	X	1	1	4	4	1	1	1	1	1	1	2
Propionitrile	N0674-70	1	1	4	1	1	1	2	X	X	X	X	X	X	X	X	X	X	X
Propyl Acetate	E0540-80	4	4	2	4	1	1	X	4	4	4	4	2	4	4	4	4	4	4
Propyl Acetone or n-Propyl Acetone	E0540-80	4	4	1	4	1	1	X	4	4	4	4	1	4	4	4	4	4	4
Propyl Alcohol	N0674-70	1	1	1	1	1	1	X	1	1	4	4	1	1	1	1	1	1	1
Propyl Nitrate	E0540-80	4	4	2	4	1	1	X	4	4	4	X	2	4	4	4	4	4	4
Propyl Propionate	E0540-80	3	3	1	3	1	1	X	1	1	4	4	1	1	1	1	1	1	2
Propylamine	E0540-80	3	3	1	3	1	1	X	1	1	4	4	1	1	1	1	1	1	2
Propylbenzene	V1164-75	X	X	X	1	1	1	X	4	4	4	3	4	4	4	4	4	2	X
Propylene	V1164-75	3	3	4	1	1	1	X	4	4	4	4	4	4	4	4	4	3	4
Propylene Chloride	V1164-75	X	X	X	1	1	1	X	4	4	4	3	4	4	4	4	4	2	X
Propylene Chlorohydrin	V1164-75	X	X	X	1	1	1	X	4	4	4	3	4	4	4	4	4	2	X
Propylene Dichloride	V1164-75	X	X	X	1	1	1	X	4	4	4	3	4	4	4	4	4	2	X
Propylene Glycol	E0540-80	3	3	1	3	1	1	X	1	1	4	4	1	1	1	1	1	1	2
Propylene Imine	V1164-75	X	X	X	1	1	1	X	4	4	4	3	4	4	4	4	4	2	X
Propylene Oxide	E0540-80	4	4	2	4	1	1	X	4	4	4	4	2	4	4	4	4	4	4
Pydraul 90e	E0540-80	4	4	1	1	1	1	1	4	X	X	X	X	X	X	X	X	X	X
Pydraul, 10E	E0540-80	4	4	1	4	1	1	X	4	4	4	4	1	4	4	4	4	4	1
Pydraul, 115E	V1164-75	4	4	1	1	1	1	X	4	4	4	4	1	4	4	4	4	3	4
Pydraul, 230C, 312C, 540C, A200	V1164-75	4	4	4	1	1	1	X	4	4	4	4	4	4	4	4	4	4	4
Pydraul, 29ELT 30E, 50E, 65E	V1164-75	4	4	1	1	1	1	X	4	4	4	4	1	4	4	4	4	1	1
Pyranol Transformer Oil	N0674-70	1	1	4	1	1	1	X	2	4	1	2	4	4	4	4	2	1	4
Pyridine	V1164-75	4	4	2	1	2	1	X	4	4	4	3	4	4	4	4	4	2	X
Pyridine Oil	E0540-80	4	4	2	4	1	1	X	4	4	4	X	2	4	4	4	4	4	4

Approximate Service Temperature Ranges for Commonly Used Basic Polymer Types*

Nitrile (General Service)	-34°C to 121°C (-30°F to 250°F)*	AFLAS	-9°C to 232°C (15°F to 450°F)*
Nitrile (Low Temperature)	-55°C to 107°C (-65°F to 225°F)*	Neoprene	-51°C to 107°C (-60°F to 225°F)*
Hydrogenated Nitrile	-32°C to 149°C (-23°F to 300°F)*	Polyacrylate	-21°C to 177°C (-5°F to 350°F)*
Ethylene Propylene	-57°C to 121°C (-70°F to 250°F)*	Polyurethane	-40°C to 82°C (-40°F to 180°F)*
Fluorocarbon	-26°C to 205°C (-15°F to 400°F)*	Butyl	-59°C to 120°C (-75°F to 250°F)*
Hifluor	-26°C to 205°C (-15°F to 400°F)*	Fluorosilicone	-73°C to 177°C (-100°F to 350°F)*
Perfluoroelastomer (Parofluor)	-26°C to 320°C (-15°F to 608°F)*	Silicone	-115°C to 232°C (-175°F to 450°F)*

NOTE: *These temperature ranges will apply to the majority of media for which the material is potentially recommended. With some media however, the service temperature range may be significantly different. ALWAYS TEST UNDER ACTUAL SERVICE CONDITIONS.



WARNING: These products can expose you to chemicals including carbon black (airborne and extracts), antimony trioxide, titanium dioxide, silica (crystalline), di(2-ethylhexyl) phthalate, ethylene thiourea, acrylonitrile, 1,3-butadiene, epichlorohydrin, toluenediisocyanate, tetrafluoroethylene, ethylbenzene, formaldehyde, furfuryl alcohol, glass fibers, methyl isobutyl ketone, nickel (metallic and compounds), lead and lead compounds which are known to the State of California to cause cancer; and 1,3-butadiene, epichlorohydrin, di(2-ethylhexyl)phthalate, di-isodecyl phthalate, ethylene thiourea, methyl isobutyl ketone, methanol, toluene, lead and lead compounds which are known to the State of California to cause birth defects and other reproductive harm. For more information go to www.P65Warnings.ca.gov.

COMPOUND COMPATIBILITY RATING
 1 - Satisfactory
 2 - Fair (usually OK for static seal)
 3 - Doubtful (sometimes OK for static seal)
 4 - Unsatisfactory
 x - Insufficient Data

	Recommended	Nitrile NBR	Hydrogenated Nitrile HNBR	Ethylene Propylene EPDM	Fluorocarbon FKM	Hifluor FKM	Perfluoroelastomer FFKM	Aflas (TFE/Propylene) FEPDM	Neoprene/Chloroprene CR	Styrene-Butadiene SBR	Polyacrylate ACM	Polyurethane AU, EU	Butyl IIR	Butadiene BR	Isoprene IR	Natural Rubber NR	Hypalon CSM	Fluorosilicone FVMQ	Silicone MQ, VMQ, PVMQ
Pyridine Sulfate	E0540-80	3	3	1	3	1	1	X	1	1	4	4	1	1	1	1	1	1	2
Pyridine Sulfonic Acid	E0540-80	3	3	1	3	1	1	X	1	1	4	4	1	1	1	1	1	1	2
Pyrogallol (Pyrogallic Acid)	V1164-75	2	2	4	1	1	1	X	4	4	4	3	4	4	4	4	4	2	X
Pyrogard 42, 43, 55	E0540-80	4	4	1	1	1	1	2	4	X	X	X	X	X	X	X	X	X	X
Pyrogard 53, Mobil Phosphate Ester	E0540-80	4	4	1	1	1	1	X	4	4	4	4	1	4	4	4	4	4	4
Pyrogard D, Mobil Water-in-Oil Emulsion	N0674-70	1	1	4	4	1	1	X	2	4	X	1	4	4	4	4	1	2	3
Pyroligneous Acid	E0540-80	4	4	2	4	1	1	X	2	4	4	4	2	4	4	4	2	4	X
Pyrolube	V1164-75	4	4	2	1	1	1	X	4	4	4	4	2	4	4	4	4	2	2
Pyrosulfuric Acid	E0540-80	3	3	1	3	1	1	X	1	1	4	4	1	1	1	1	1	1	2
Pyrosulfuryl Chloride	V1164-75	2	2	4	1	1	1	X	4	4	4	3	4	4	4	4	4	2	X
Pyrrole	E0540-80	4	4	4	4	1	1	X	4	2	4	X	4	2	2	2	2	4	2
Pyruvic Acid	E0540-80	3	3	1	3	1	1	X	1	1	4	4	1	1	1	1	1	1	2
- Q -																			
Quinidine	V1164-75	2	2	4	1	1	1	X	4	4	4	3	4	4	4	4	4	2	X
Quinine	V1164-75	2	2	4	1	1	1	X	4	4	4	3	4	4	4	4	4	2	X
Quinine Bisulfate	E0540-80	3	3	1	3	1	1	X	1	1	4	4	1	1	1	1	1	1	2
Quinine Hydrochloride	E0540-80	3	3	1	3	1	1	X	1	1	4	4	1	1	1	1	1	1	2
Quinine Sulfate	E0540-80	3	3	1	3	1	1	X	1	1	4	4	1	1	1	1	1	1	2
Quinine Tartrate	E0540-80	3	3	1	3	1	1	X	1	1	4	4	1	1	1	1	1	1	2
Quinizarin	V1164-75	2	2	4	1	1	1	X	4	4	4	3	4	4	4	4	4	2	X
Quinoline	V1164-75	2	2	4	1	1	1	X	4	4	4	3	4	4	4	4	4	2	X
Quinone	V1164-75	2	2	4	1	1	1	X	4	4	4	3	4	4	4	4	4	2	X
Quintolubric	N0674-70	X	X	X	X	X	X	X	X	X	X	X	X	X	X	X	X	X	X
Quintolubric 888	V1164-75	1	1	4	1	1	1	1	2	X	X	1	2	X	X	X	X	X	X
- R -																			
Radiation (Gamma, 1.0 E+07 Rads)	E0740-75	3	3	2	4	3	2	X	X	X	X	4	4	X	X	4	X	4	2
Raffinate	V1164-75	2	2	4	1	1	1	X	4	4	4	3	4	4	4	4	4	2	X
Rapeseed Oil	E0540-80	2	2	1	1	1	1	X	2	4	2	2	1	4	4	4	2	1	4
Red Line 100 Oil	N0674-70	1	1	4	1	1	1	X	2	4	1	1	4	4	4	4	2	1	4
Red Oil (MIL-H-5606)	N0674-70	1	1	4	1	1	1	X	2	4	1	1	4	4	4	4	2	1	4
Resorcinol	E0540-80	3	3	1	3	1	1	X	1	1	4	4	1	1	1	1	1	1	2
Rhodium	V3819-75	X	X	X	X	1	1	X	X	X	X	X	X	X	X	X	X	X	X
Riboflavin	V1164-75	2	2	4	1	1	1	X	4	4	4	3	4	4	4	4	4	2	X
Ricinoleic Acid	V1164-75	2	2	4	1	1	1	X	4	4	4	3	4	4	4	4	4	2	X
RJ-1 (MIL-F-25558)	N0602-70	1	1	4	1	1	1	X	2	4	1	1	4	4	4	4	2	1	4
RJ-4 (MIL-F-82522)	N0602-70	2	2	4	1	1	1	X	4	4	2	2	4	X	X	4	X	1	4
Rosin	V1164-75	2	2	4	1	1	1	X	4	4	4	3	4	4	4	4	4	2	X
RP-1 (MIL-R-25576)	N0602-70	1	1	4	1	1	1	X	2	4	1	1	4	4	4	4	2	1	4

Approximate Service Temperature Ranges for Commonly Used Basic Polymer Types*

Nitrile (General Service)	-34°C to 121°C (-30°F to 250°F)*	AFLAS	-9°C to 232°C (15°F to 450°F)*
Nitrile (Low Temperature)	-55°C to 107°C (-65°F to 225°F)*	Neoprene	-51°C to 107°C (-60°F to 225°F)*
Hydrogenated Nitrile	-32°C to 149°C (-23°F to 300°F)*	Polyacrylate	-21°C to 177°C (-5°F to 350°F)*
Ethylene Propylene	-57°C to 121°C (-70°F to 250°F)*	Polyurethane	-40°C to 82°C (-40°F to 180°F)*
Fluorocarbon	-26°C to 205°C (-15°F to 400°F)*	Butyl	-59°C to 120°C (-75°F to 250°F)*
Hifluor	-26°C to 205°C (-15°F to 400°F)*	Fluorosilicone	-73°C to 177°C (-100°F to 350°F)*
Perfluoroelastomer (Parofluor)	-26°C to 320°C (-15°F to 608°F)*	Silicone	-115°C to 232°C (-175°F to 450°F)*

NOTE: *These temperature ranges will apply to the majority of media for which the material is potentially recommended. With some media however, the service temperature range may be significantly different. ALWAYS TEST UNDER ACTUAL SERVICE CONDITIONS.

WARNING: These products can expose you to chemicals including carbon black (airborne and extracts), antimony trioxide, titanium dioxide, silica (crystalline), di(2-ethylhexyl) phthalate, ethylene thiourea, acrylonitrile, 1,3-butadiene, epichlorohydrin, toluenediisocyanate, tetrafluoroethylene, ethylbenzene, formaldehyde, furfuryl alcohol, glass fibers, methyl isobutyl ketone, nickel (metallic and compounds), lead and lead compounds which are known to the State of California to cause cancer; and 1,3-butadiene, epichlorohydrin, di(2-ethylhexyl)phthalate, di-isodecyl phthalate, ethylene thiourea, methyl isobutyl ketone, methanol, toluene, lead and lead compounds which are known to the State of California to cause birth defects and other reproductive harm. For more information go to www.P65Warnings.ca.gov.

COMPOUND COMPATIBILITY RATING
 1 - Satisfactory
 2 - Fair (usually OK for static seal)
 3 - Doubtful (sometimes OK for static seal)
 4 - Unsatisfactory
 x - Insufficient Data

	Recommended	Nitrile NBR	Hydrogenated Nitrile HNBR	Ethylene Propylene EPDM	Fluorocarbon FKM	Hifluor FKM	Perfluoroelastomer FFKM	Aflas (TFE/Propylene) FFKM	Neoprene/Chloroprene CR	Styrene-Butadiene SBR	Polyacrylate ACM	Polyurethane AU, EU	Butyl IIR	Butadiene BR	Isoprene IR	Natural Rubber NR	Hypalon CSM	Fluorosilicone FVMQ	Silicone MQ, VMQ, PVMQ
-S-																			
Saccharin Solution	E0540-80	3	3	1	3	1	1	X	1	1	4	4	1	1	1	1	1	1	2
Sal Ammoniac	E0540-80	1	1	1	1	1	1	X	1	1	1	1	1	1	1	1	1	1	2
Salicylic Acid	E0540-80	2	2	1	1	1	1	X	X	2	X	X	1	2	1	1	X	1	X
Santo Safe 300	V1164-75	4	4	3	1	1	1	X	4	4	4	X	3	4	4	4	X	1	1
Sea (Salt) Water	N0674-70	1	1	1	1	1	1	X	2	1	4	2	1	1	1	1	1	1	1
Sebacic Acid	E0540-80	3	3	1	3	1	1	X	1	1	4	4	1	1	1	1	1	1	2
Selenic Acid	E0540-80	3	3	1	3	1	1	X	1	1	4	4	1	1	1	1	1	1	2
Selenous Acid	E0540-80	3	3	1	3	1	1	X	1	1	4	4	1	1	1	1	1	1	2
Sewage	N0674-70	1	1	1	1	1	1	X	2	1	4	4	1	1	1	1	1	1	1
SF 1154 GE Silicone Fluid	E0740-75	2	2	1	1	1	1	X	1	1	1	2	1	X	1	1	1	1	4
SF1147 GE Silicone Fluid	V1164-75	2	2	3	1	1	1	X	X	X	X	X	3	X	X	X	X	X	4
SF96 GE Silicone Fluid	E0740-75	2	2	1	1	1	1	X	1	1	1	2	1	1	1	1	1	1	4
Shell 3XF Mine Fluid (Fire resist hydr.)	N0674-70	1	1	4	1	1	1	X	2	4	4	4	4	4	4	4	2	1	X
Shell Alvania Grease #2	N0674-70	1	1	4	1	1	1	X	2	4	1	1	4	4	4	4	4	1	2
Shell Carnea 19 and 29	N0674-70	1	1	4	1	1	1	X	4	4	1	2	4	4	4	4	4	1	X
Shell Diala	N0674-70	1	1	4	1	1	1	X	2	4	1	2	4	4	4	4	4	1	4
Shell IruS 905	N0674-70	1	1	4	1	1	1	X	2	4	1	1	4	4	4	4	4	1	4
Shell Lo Hydrax 27 and 29	N0674-70	1	1	4	1	1	1	X	2	4	1	2	4	4	4	4	4	1	4
Shell Macome 72	N0674-70	1	1	4	1	1	1	X	2	4	1	2	4	4	4	4	4	1	4
Shell Tellus #32 Pet. Base	N0674-70	1	1	4	1	1	1	X	2	4	1	1	4	4	4	4	4	1	4
Shell Tellus #68	N0674-70	1	1	4	1	1	1	X	2	4	1	1	4	4	4	4	4	1	4
Shell Tellus 27 (Petroleum Base)	N0674-70	1	1	4	1	1	1	1	2	X	X	X	X	X	X	X	X	X	X
Shell Tellus 33	N0674-70	1	1	4	1	1	1	1	2	X	X	X	X	X	X	X	X	X	X
Shell UMF (5% Aromatic)	N0674-70	1	1	4	1	1	1	X	2	4	1	1	4	4	4	4	4	1	4
Shellac	E0540-80	3	3	1	3	1	1	X	1	1	4	4	1	1	1	1	1	1	2
Silane	V3819-75	X	X	X	X	1	1	X	X	X	X	X	X	X	X	X	X	X	X
Silicate Esters	V1164-75	2	2	4	1	1	1	X	1	4	X	1	4	4	4	4	X	1	4
Silicon Fluoride	V3819-75	X	X	X	X	1	1	X	X	X	X	X	X	X	X	X	X	X	X
Silicon Tetrachloride	V3819-75	X	X	X	X	1	1	X	X	X	X	X	X	X	X	X	X	X	X
Silicon Tetrafluoride	V3819-75	X	X	X	X	1	1	X	X	X	X	X	X	X	X	X	X	X	X
Silicone Greases	E0540-80	1	1	1	1	1	1	X	1	1	1	1	1	1	1	1	1	2	3
Silicone Oils	E0540-80	1	1	1	1	1	1	X	1	1	1	1	1	1	1	1	1	3	3
Silver Bromide	E0540-80	3	3	1	3	1	1	X	1	1	4	4	1	1	1	1	1	1	2
Silver Chloride	E0540-80	3	3	1	3	1	1	X	1	1	4	4	1	1	1	1	1	1	2
Silver Cyanide	E0540-80	3	3	1	3	1	1	X	1	1	4	4	1	1	1	1	1	1	2
Silver Nitrate	E0540-80	2	2	1	1	1	1	X	1	1	1	1	1	1	1	1	1	1	1
Silver Sulfate	E0540-80	3	3	1	3	1	1	X	1	1	4	4	1	1	1	1	1	1	2
Sinclair Opaline CX-EP Lube	N0674-70	1	1	4	1	1	1	X	2	4	1	1	4	4	4	4	2	1	4
Skelly, Solvent B, C, E	N0674-70	1	1	4	1	1	1	X	4	4	X	X	4	4	4	4	4	1	X
Skydrol 500 B4	E1267-80	4	4	1	4	1	1	X	4	4	4	4	2	4	4	4	4	3	3

Approximate Service Temperature Ranges for Commonly Used Basic Polymer Types*

Nitrile (General Service)	-34°C to 121°C (-30°F to 250°F)*	AFLAS	-9°C to 232°C (15°F to 450°F)*
Nitrile (Low Temperature)	-55°C to 107°C (-65°F to 225°F)*	Neoprene	-51°C to 107°C (-60°F to 225°F)*
Hydrogenated Nitrile	-32°C to 149°C (-23°F to 300°F)*	Polyacrylate	-21°C to 177°C (-5°F to 350°F)*
Ethylene Propylene	-57°C to 121°C (-70°F to 250°F)*	Polyurethane	-40°C to 82°C (-40°F to 180°F)*
Fluorocarbon	-26°C to 205°C (-15°F to 400°F)*	Butyl	-59°C to 120°C (-75°F to 250°F)*
Hifluor	-26°C to 205°C (-15°F to 400°F)*	Fluorosilicone	-73°C to 177°C (-100°F to 350°F)*
Perfluoroelastomer (Parofluor)	-26°C to 320°C (-15°F to 608°F)*	Silicone	-115°C to 232°C (-175°F to 450°F)*

NOTE: *These temperature ranges will apply to the majority of media for which the material is potentially recommended. With some media however, the service temperature range may be significantly different. ALWAYS TEST UNDER ACTUAL SERVICE CONDITIONS.

WARNING: These products can expose you to chemicals including carbon black (airborne and extracts), antimony trioxide, titanium dioxide, silica (crystalline), di(2-ethylhexyl) phthalate, ethylene thiourea, acrylonitrile, 1,3-butadiene, epichlorohydrin, toluenediisocyanate, tetrafluoroethylene, ethylbenzene, formaldehyde, furfuryl alcohol, glass fibers, methyl isobutyl ketone, nickel (metallic and compounds), lead and lead compounds which are known to the State of California to cause cancer; and 1,3-butadiene, epichlorohydrin, di(2-ethylhexyl)phthalate, di-isodecyl phthalate, ethylene thiourea, methyl isobutyl ketone, methanol, toluene, lead and lead compounds which are known to the State of California to cause birth defects and other reproductive harm. For more information go to www.P65Warnings.ca.gov.

COMPOUND COMPATIBILITY RATING
 1 - Satisfactory
 2 - Fair (usually OK for static seal)
 3 - Doubtful (sometimes OK for static seal)
 4 - Unsatisfactory
 x - Insufficient Data

	Recommended	Nitrile NBR	Hydrogenated Nitrile HNBR	Ethylene Propylene EPDM	Fluorocarbon FKM	Hifluor FKM	Perfluoroelastomer FFKM	Aflas (TFE/Propylene) FEPDM	Neoprene/Chloroprene CR	Styrene-Butadiene SBR	Polyacrylate ACM	Polyurethane AU, EU	Butyl IIR	Butadiene BR	Isoprene IR	Natural Rubber NR	Hypalon CSM	Fluorosilicone FVMQ	Silicone MQ, VMQ, PVMQ	
Skydrol 7000	E1267-80	4	4	1	2	1	1	1	4	X	X	X	X	X	X	X	X	X	X	
Skydrol LD-4	E1267-80	4	4	1	4	1	1	X	4	4	4	4	2	4	4	4	4	3	3	
Soap Solutions	E0540-80	1	1	1	1	1	1	X	2	2	4	4	1	1	1	2	1	1	1	
Socony Mobile Type A	N0674-70	1	1	4	1	1	1	X	2	4	1	2	4	4	4	4	4	2	4	
Socony Vacuum AMV AC781 (Grease)	N0674-70	1	1	4	1	1	1	X	2	4	1	2	4	4	4	4	4	2	4	
Socony Vacuum PD959B	N0674-70	1	1	4	1	1	1	X	2	4	1	1	4	4	4	4	2	1	4	
Soda Ash	N0674-70	1	1	1	1	1	1	X	1	1	X	X	1	1	1	1	1	1	1	
Sodium (Molten)	Factory	X	X	X	X	4	4	X	X	X	X	X	X	X	X	X	X	X	X	
Sodium Acetate	E0540-80	2	2	1	4	1	1	X	2	4	3	3	1	4	1	1	1	1	4	4
Sodium Acid Bisulfate	E0540-80	3	3	1	3	1	1	X	1	1	4	4	1	1	1	1	1	1	2	
Sodium Acid Fluoride	E0540-80	3	3	1	3	1	1	X	1	1	4	4	1	1	1	1	1	1	2	
Sodium Acid Sulfate	E0540-80	3	3	1	3	1	1	X	1	1	4	4	1	1	1	1	1	1	2	
Sodium Aluminate	E0540-80	3	3	1	3	1	1	X	1	1	4	4	1	1	1	1	1	1	2	
Sodium Aluminate Sulfate	E0540-80	3	3	1	3	1	1	X	1	1	4	4	1	1	1	1	1	1	2	
Sodium Anthraquinone Disulfate	E0540-80	3	3	1	3	1	1	X	1	1	4	4	1	1	1	1	1	1	2	
Sodium Antimonate	E0540-80	3	3	1	3	1	1	X	1	1	4	4	1	1	1	1	1	1	2	
Sodium Arsenate	E0540-80	3	3	1	3	1	1	X	1	1	4	4	1	1	1	1	1	1	2	
Sodium Arsenite	E0540-80	3	3	1	3	1	1	X	1	1	4	4	1	1	1	1	1	1	2	
Sodium Benzoate	E0540-80	3	3	1	3	1	1	X	1	1	4	4	1	1	1	1	1	1	2	
Sodium Bicarbonate (Baking Soda)	N0674-70	1	1	1	1	1	1	X	1	1	X	X	1	1	1	1	1	1	1	
Sodium Bichromate	E0540-80	3	3	1	3	1	1	X	1	1	4	4	1	1	1	1	1	1	2	
Sodium Bifluoride	E0540-80	3	3	1	3	1	1	X	1	1	4	4	1	1	1	1	1	1	2	
Sodium Bisulfate or Bisulfite	N0674-70	1	1	1	1	1	1	X	1	2	4	X	1	2	2	1	1	1	1	
Sodium Bisulfide	E0540-80	3	3	1	3	1	1	X	1	1	4	4	1	1	1	1	1	1	2	
Sodium Bitartrate	E0540-80	3	3	1	3	1	1	X	1	1	4	4	1	1	1	1	1	1	2	
Sodium Borate	N0674-70	1	1	1	1	1	1	X	1	1	X	X	1	1	1	1	1	1	1	
Sodium Bromate	E0540-80	3	3	1	3	1	1	X	1	1	4	4	1	1	1	1	1	1	2	
Sodium Bromide	E0540-80	3	3	1	3	1	1	X	1	1	4	4	1	1	1	1	1	1	2	
Sodium Carbonate (Soda Ash)	N0674-70	1	1	1	1	1	1	X	1	1	X	X	1	1	1	1	1	1	1	
Sodium Chlorate	E0540-80	3	3	1	3	1	1	X	1	1	4	4	1	1	1	1	1	1	2	
Sodium Chloride	N0674-70	1	1	1	1	1	1	X	1	1	X	1	1	1	1	1	1	X	1	
Sodium Chlorite	E0540-80	3	3	1	3	1	1	X	1	1	4	4	1	1	1	1	1	1	2	
Sodium Chloroacetate	E0540-80	3	3	1	3	1	1	X	1	1	4	4	1	1	1	1	1	1	2	
Sodium Chromate	E0540-80	3	3	1	3	1	1	X	1	1	4	4	1	1	1	1	1	1	2	
Sodium Citrate	E0540-80	3	3	1	3	1	1	X	1	1	4	4	1	1	1	1	1	1	2	
Sodium Cyanamide	E0540-80	3	3	1	3	1	1	X	1	1	4	4	1	1	1	1	1	1	2	
Sodium Cyanate	E0540-80	3	3	1	3	1	1	X	1	1	4	4	1	1	1	1	1	1	2	
Sodium Cyanide	N0674-70	1	1	1	X	1	1	X	1	1	X	X	1	1	1	1	1	X	1	
Sodium Diacetate	E0540-80	3	3	1	3	1	1	X	1	1	4	4	1	1	1	1	1	1	2	
Sodium Diphenyl Sulfonate	E0540-80	3	3	1	3	1	1	X	1	1	4	4	1	1	1	1	1	1	2	

Approximate Service Temperature Ranges for Commonly Used Basic Polymer Types*

Nitrile (General Service)	-34°C to 121°C (-30°F to 250°F)*	AFLAS	-9°C to 232°C (15°F to 450°F)*
Nitrile (Low Temperature)	-55°C to 107°C (-65°F to 225°F)*	Neoprene	-51°C to 107°C (-60°F to 225°F)*
Hydrogenated Nitrile	-32°C to 149°C (-23°F to 300°F)*	Polyacrylate	-21°C to 177°C (-5°F to 350°F)*
Ethylene Propylene	-57°C to 121°C (-70°F to 250°F)*	Polyurethane	-40°C to 82°C (-40°F to 180°F)*
Fluorocarbon	-26°C to 205°C (-15°F to 400°F)*	Butyl	-59°C to 120°C (-75°F to 250°F)*
Hifluor	-26°C to 205°C (-15°F to 400°F)*	Fluorosilicone	-73°C to 177°C (-100°F to 350°F)*
Perfluoroelastomer (Parofluor)	-26°C to 320°C (-15°F to 608°F)*	Silicone	-115°C to 232°C (-175°F to 450°F)*

NOTE: *These temperature ranges will apply to the majority of media for which the material is potentially recommended. With some media however, the service temperature range may be significantly different. ALWAYS TEST UNDER ACTUAL SERVICE CONDITIONS.

WARNING: These products can expose you to chemicals including carbon black (airborne and extracts), antimony trioxide, titanium dioxide, silica (crystalline), di(2-ethylhexyl) phthalate, ethylene thiourea, acrylonitrile, 1,3-butadiene, epichlorohydrin, toluenediisocyanate, tetrafluoroethylene, ethylbenzene, formaldehyde, furfuryl alcohol, glass fibers, methyl isobutyl ketone, nickel (metallic and compounds), lead and lead compounds which are known to the State of California to cause cancer; and 1,3-butadiene, epichlorohydrin, di(2-ethylhexyl)phthalate, di-isodecyl phthalate, ethylene thiourea, methyl isobutyl ketone, methanol, toluene, lead and lead compounds which are known to the State of California to cause birth defects and other reproductive harm. For more information go to www.P65Warnings.ca.gov.

Compatibility Tables for Gases, Fluids, Solids

COMPOUND COMPATIBILITY RATING
 1 - Satisfactory
 2 - Fair (usually OK for static seal)
 3 - Doubtful (sometimes OK for static seal)
 4 - Unsatisfactory
 x - Insufficient Data

	Recommended	Nitrile NBR	Hydrogenated Nitrile HNBR	Ethylene Propylene EPDM	Fluorocarbon FKM	Hifluor FKM	Perfluoroelastomer FFKM	Aflas (TFE/Propylene) FEPDM	Neoprene/Chloroprene CR	Styrene-Butadiene SBR	Polyacrylate ACM	Polyurethane AU, EU	Butyl IIR	Butadiene BR	Isoprene IR	Natural Rubber NR	Hypalon CSM	Fluorosilicone FVMQ	Silicone MQ, VMQ, PVMQ
Sodium Diphosphate	E0540-80	3	3	1	3	1	1	X	1	1	4	4	1	1	1	1	1	1	2
Sodium Disilicate	E0540-80	3	3	1	3	1	1	X	1	1	4	4	1	1	1	1	1	1	2
Sodium Ethylate	E0540-80	3	3	1	3	1	1	X	1	1	4	4	1	1	1	1	1	1	2
Sodium Ferricyanide	E0540-80	3	3	1	3	1	1	X	1	1	4	4	1	1	1	1	1	1	2
Sodium Ferrocyanide	E0540-80	3	3	1	3	1	1	X	1	1	4	4	1	1	1	1	1	1	2
Sodium Fluoride	E0540-80	3	3	1	3	1	1	X	1	1	4	4	1	1	1	1	1	1	2
Sodium Fluorosilicate	E0540-80	3	3	1	3	1	1	X	1	1	4	4	1	1	1	1	1	1	2
Sodium Glutamate	E0540-80	3	3	1	3	1	1	X	1	1	4	4	1	1	1	1	1	1	2
Sodium Hydride	V3819-75	X	X	X	X	1	1	X	X	X	X	X	X	X	X	X	X	X	X
Sodium Hydrogen Sulfate	E0540-80	3	3	1	3	1	1	X	1	1	4	4	1	1	1	1	1	1	2
Sodium Hydrosulfide	E0540-80	3	3	1	3	1	1	X	1	1	4	4	1	1	1	1	1	1	2
Sodium Hydrosulfite	E0540-80	3	3	1	3	1	1	X	1	1	4	4	1	1	1	1	1	1	2
Sodium Hydroxide, 3 Molar	E0540-80	2	2	1	2	1	1	X	2	2	4	2	1	1	1	1	1	2	1
Sodium Hypochlorite	E0540-80	2	2	1	1	1	1	X	2	2	4	4	1	2	2	2	1	2	2
Sodium Hypophosphate	E0540-80	3	3	1	3	1	1	X	1	1	4	4	1	1	1	1	1	1	2
Sodium Hypophosphite	E0540-80	3	3	1	3	1	1	X	1	1	4	4	1	1	1	1	1	1	2
Sodium Hyposulfite	E0540-80	3	3	1	3	1	1	X	1	1	4	4	1	1	1	1	1	1	2
Sodium Iodide	E0540-80	3	3	1	3	1	1	X	1	1	4	4	1	1	1	1	1	1	2
Sodium Lactate	E0540-80	3	3	1	3	1	1	X	1	1	4	4	1	1	1	1	1	1	2
Sodium Metaphosphate	N0674-70	1	1	1	1	1	1	X	2	1	X	X	1	1	1	1	2	1	X
Sodium Metasilicate	E0540-80	3	3	1	3	1	1	X	1	1	4	4	1	1	1	1	1	1	2
Sodium Methylate	E0540-80	3	3	1	3	1	1	X	1	1	4	4	1	1	1	1	1	1	2
Sodium Monophosphate	E0540-80	3	3	1	3	1	1	X	1	1	4	4	1	1	1	1	1	1	2
Sodium Nitrate	E0540-80	2	2	1	X	1	1	X	2	2	X	X	1	1	1	2	1	X	4
Sodium Oleate	E0540-80	3	3	1	3	1	1	X	1	1	4	4	1	1	1	1	1	1	2
Sodium Orthosilicate	E0540-80	3	3	1	3	1	1	X	1	1	4	4	1	1	1	1	1	1	2
Sodium Oxalate	E0540-80	3	3	1	3	1	1	X	1	1	4	4	1	1	1	1	1	1	2
Sodium Perborate	E0540-80	2	2	1	1	1	1	X	2	2	X	X	1	2	2	2	2	1	2
Sodium Percarbonate	E0540-80	3	3	1	3	1	1	X	1	1	4	4	1	1	1	1	1	1	2
Sodium Perchlorate	E0540-80	3	3	1	3	1	1	X	1	1	4	4	1	1	1	1	1	1	2
Sodium Peroxide	E0540-80	2	2	1	1	1	1	X	2	2	4	4	1	2	2	2	2	1	4
Sodium Persulfate	E0540-80	3	3	1	3	1	1	X	1	1	4	4	1	1	1	1	1	1	2
Sodium Phenolate	E0540-80	3	3	1	3	1	1	X	1	1	4	4	1	1	1	1	1	1	2
Sodium Phenoxide	E0540-80	3	3	1	3	1	1	X	1	1	4	4	1	1	1	1	1	1	2
Sodium Phosphate (Dibasic)	N0674-70	1	1	1	1	1	1	X	2	1	1	1	1	1	1	1	1	X	4
Sodium Phosphate (Mono)	N0674-70	1	1	1	1	1	1	X	2	1	1	1	1	1	1	1	1	X	4
Sodium Phosphate (Tribasic)	N0674-70	1	1	1	1	1	1	X	2	1	1	1	1	1	1	1	1	X	1
Sodium Plumbite	E0540-80	3	3	1	3	1	1	X	1	1	4	4	1	1	1	1	1	1	2
Sodium Pyrophosphate	E0540-80	3	3	1	3	1	1	X	1	1	4	4	1	1	1	1	1	1	2
Sodium Resinate	E0540-80	3	3	1	3	1	1	X	1	1	4	4	1	1	1	1	1	1	2

Approximate Service Temperature Ranges for Commonly Used Basic Polymer Types*

Nitrile (General Service)	-34°C to 121°C (-30°F to 250°F)*	AFLAS	-9°C to 232°C (15°F to 450°F)*
Nitrile (Low Temperature)	-55°C to 107°C (-65°F to 225°F)*	Neoprene	-51°C to 107°C (-60°F to 225°F)*
Hydrogenated Nitrile	-32°C to 149°C (-23°F to 300°F)*	Polyacrylate	-21°C to 177°C (-5°F to 350°F)*
Ethylene Propylene	-57°C to 121°C (-70°F to 250°F)*	Polyurethane	-40°C to 82°C (-40°F to 180°F)*
Fluorocarbon	-26°C to 205°C (-15°F to 400°F)*	Butyl	-59°C to 120°C (-75°F to 250°F)*
Hifluor	-26°C to 205°C (-15°F to 400°F)*	Fluorosilicone	-73°C to 177°C (-100°F to 350°F)*
Perfluoroelastomer (Parofluor)	-26°C to 320°C (-15°F to 608°F)*	Silicone	-115°C to 232°C (-175°F to 450°F)*

NOTE: *These temperature ranges will apply to the majority of media for which the material is potentially recommended. With some media however, the service temperature range may be significantly different. ALWAYS TEST UNDER ACTUAL SERVICE CONDITIONS.

WARNING: These products can expose you to chemicals including carbon black (airborne and extracts), antimony trioxide, titanium dioxide, silica (crystalline), di(2-ethylhexyl) phthalate, ethylene thiourea, acrylonitrile, 1,3-butadiene, epichlorohydrin, toluenediisocyanate, tetrafluoroethylene, ethylbenzene, formaldehyde, furfuryl alcohol, glass fibers, methyl isobutyl ketone, nickel (metallic and compounds), lead and lead compounds which are known to the State of California to cause cancer; and 1,3-butadiene, epichlorohydrin, di(2-ethylhexyl)phthalate, di-isodecyl phthalate, ethylene thiourea, methyl isobutyl ketone, methanol, toluene, lead and lead compounds which are known to the State of California to cause birth defects and other reproductive harm. For more information go to www.P65Warnings.ca.gov.

COMPOUND COMPATIBILITY RATING
 1 - Satisfactory
 2 - Fair (usually OK for static seal)
 3 - Doubtful (sometimes OK for static seal)
 4 - Unsatisfactory
 x - Insufficient Data

	Recommended	Nitrile NBR	Hydrogenated Nitrile HNBR	Ethylene Propylene EPDM	Fluorocarbon FKM	Hifluor FKM	Perfluoroelastomer FFKM	Aflas (TFE/Propylene) FEPDM	Neoprene/Chloroprene CR	Styrene-Butadiene SBR	Polyacrylate ACM	Polyurethane AU, EU	Butyl IIR	Butadiene BR	Isoprene IR	Natural Rubber NR	Hypalon CSM	Fluorosilicone FVMQ	Silicone MQ, VMQ, PVMQ
Sodium Salicylate	E0540-80	3	3	1	3	1	1	X	1	1	4	4	1	1	1	1	1	1	2
Sodium Salts	N0674-70	1	1	1	1	1	1	X	2	1	1	1	1	1	1	1	1	1	1
Sodium Sesquisilicate	V3819-75	X	X	X	X	1	1	X	X	X	X	X	X	X	X	X	X	X	X
Sodium Silicate	N0674-70	1	1	1	1	1	1	X	1	1	X	X	1	1	1	1	1	X	X
Sodium Silicofluoride	V3819-75	X	X	X	X	1	1	X	X	X	X	X	X	X	X	X	X	X	X
Sodium Stannate	E0540-80	3	3	1	3	1	1	X	1	1	4	4	1	1	1	1	1	1	2
Sodium Sulfate	N0674-70	1	1	1	1	1	1	X	1	2	4	1	1	2	2	2	1	1	1
Sodium Sulfide and Sulfite	N0674-70	1	1	1	1	1	1	X	1	2	4	1	1	2	2	2	1	1	1
Sodium Sulfo cyanide	E0540-80	3	3	1	3	1	1	X	1	1	4	4	1	1	1	1	1	1	2
Sodium Tartrate	E0540-80	3	3	1	3	1	1	X	1	1	4	4	1	1	1	1	1	1	2
Sodium Tetraborate	E0540-80	3	3	1	3	1	1	X	1	1	4	4	1	1	1	1	1	1	2
Sodium Tetraphosphate	E0540-80	3	3	1	3	1	1	X	1	1	4	4	1	1	1	1	1	1	2
Sodium Tetrasulfide	E0540-80	3	3	1	3	1	1	X	1	1	4	4	1	1	1	1	1	1	2
Sodium Thioarsenate	E0540-80	3	3	1	3	1	1	X	1	1	4	4	1	1	1	1	1	1	2
Sodium Thiocyanate	E0540-80	3	3	1	3	1	1	X	1	1	4	4	1	1	1	1	1	1	2
Sodium Thiosulfate	E0540-80	2	2	1	1	1	1	X	1	2	4	1	1	2	2	2	1	1	1
Sodium Trichloroacetate	E0540-80	3	3	1	3	1	1	X	1	1	4	4	1	1	1	1	1	1	2
Sodium Triphosphate	E0540-80	3	3	1	3	1	1	X	1	1	4	4	1	1	1	1	1	1	2
Solvesso 100, 150	V3819-75	X	X	X	X	1	1	X	X	X	X	X	X	X	X	X	X	X	X
Sorbitol	E0540-80	3	3	1	3	1	1	X	1	1	4	4	1	1	1	1	1	1	2
Sour Crude Oil	V1238-95	3	3	4	1	1	1	X	4	4	4	4	4	4	4	4	X	4	4
Sour Natural Gas	V1238-95	3	3	4	1	1	1	X	4	4	4	4	4	4	4	4	X	4	4
Sovasol No. 1, 2, and 3	N0674-70	1	1	4	1	1	1	X	2	4	2	2	4	4	4	4	2	1	4
Sovasol No. 73 and 74	V1164-75	2	2	4	1	1	1	X	2	4	2	2	4	4	4	4	2	1	4
Soybean Oil	N0674-70	1	1	3	1	1	1	X	3	4	1	X	3	4	4	4	3	1	1
Spry	N0674-70	1	1	2	1	1	1	X	2	4	1	1	2	4	4	4	4	1	1
SR-10 Fuel	N0674-70	1	1	4	1	1	1	X	4	4	2	2	4	4	4	4	4	1	4
SR-6 Fuel	V1164-75	2	2	4	1	1	1	X	4	4	2	2	4	4	4	4	4	1	4
Standard Oil Mobilube GX90-EP Lube	N0674-70	1	1	4	1	1	1	X	2	4	1	1	4	4	4	4	2	1	4
Stannic Ammonium Chloride	E0540-80	3	3	1	3	1	1	X	1	1	4	4	1	1	1	1	1	1	2
Stannic Chloride	N0674-70	1	1	1	1	1	1	X	4	1	X	X	1	1	1	1	4	1	2
Stannic Chloride, 50%	N0674-70	1	1	1	1	1	1	X	4	1	X	X	1	1	1	1	4	1	2
Stannic Tetrachloride	E0540-80	3	3	1	3	1	1	X	1	1	4	4	1	1	1	1	1	1	2
Stannous Bisulfate	E0540-80	3	3	1	3	1	1	X	1	1	4	4	1	1	1	1	1	1	2
Stannous Bromide	E0540-80	3	3	1	3	1	1	X	1	1	4	4	1	1	1	1	1	1	2
Stannous Chloride (15%)	N0674-70	1	1	1	1	1	1	X	1	1	X	X	1	1	1	1	1	1	2
Stannous Fluoride	E0540-80	3	3	1	3	1	1	X	1	1	4	4	1	1	1	1	1	1	2
Stannous Sulfate	E0540-80	3	3	1	3	1	1	X	1	1	4	4	1	1	1	1	1	1	2
Stauffer 7700	V1164-75	2	2	4	1	1	1	X	4	4	2	X	4	4	4	4	4	2	4
Steam Below 400°F	E0692-75	4	4	1	4	1	1	X	4	4	4	4	2	4	4	4	4	4	3

Approximate Service Temperature Ranges for Commonly Used Basic Polymer Types*

Nitrile (General Service)	-34°C to 121°C (-30°F to 250°F)*	AFLAS	-9°C to 232°C (15°F to 450°F)*
Nitrile (Low Temperature)	-55°C to 107°C (-65°F to 225°F)*	Neoprene	-51°C to 107°C (-60°F to 225°F)*
Hydrogenated Nitrile	-32°C to 149°C (-23°F to 300°F)*	Polyacrylate	-21°C to 177°C (-5°F to 350°F)*
Ethylene Propylene	-57°C to 121°C (-70°F to 250°F)*	Polyurethane	-40°C to 82°C (-40°F to 180°F)*
Fluorocarbon	-26°C to 205°C (-15°F to 400°F)*	Butyl	-59°C to 120°C (-75°F to 250°F)*
Hifluor	-26°C to 205°C (-15°F to 400°F)*	Fluorosilicone	-73°C to 177°C (-100°F to 350°F)*
Perfluoroelastomer (Parofluor)	-26°C to 320°C (-15°F to 608°F)*	Silicone	-115°C to 232°C (-175°F to 450°F)*

NOTE: *These temperature ranges will apply to the majority of media for which the material is potentially recommended. With some media however, the service temperature range may be significantly different. ALWAYS TEST UNDER ACTUAL SERVICE CONDITIONS.

WARNING: These products can expose you to chemicals including carbon black (airborne and extracts), antimony trioxide, titanium dioxide, silica (crystalline), di(2-ethylhexyl) phthalate, ethylene thiourea, acrylonitrile, 1,3-butadiene, epichlorohydrin, toluenediisocyanate, tetrafluoroethylene, ethylbenzene, formaldehyde, furfuryl alcohol, glass fibers, methyl isobutyl ketone, nickel (metallic and compounds), lead and lead compounds which are known to the State of California to cause cancer; and 1,3-butadiene, epichlorohydrin, di(2-ethylhexyl)phthalate, di-isodecyl phthalate, ethylene thiourea, methyl isobutyl ketone, methanol, toluene, lead and lead compounds which are known to the State of California to cause birth defects and other reproductive harm. For more information go to www.P65Warnings.ca.gov.

Compatibility Tables for Gases, Fluids, Solids

COMPOUND COMPATIBILITY RATING
 1 - Satisfactory
 2 - Fair (usually OK for static seal)
 3 - Doubtful (sometimes OK for static seal)
 4 - Unsatisfactory
 x - Insufficient Data

	Recommended	Nitrile NBR	Hydrogenated Nitrile HNBR	Ethylene Propylene EPDM	Fluorocarbon FKM	Hifluor FKM	Perfluoroelastomer FFKM	Aflas (TFE/Propylene) FEPDM	Neoprene/Chloroprene CR	Styrene-Butadiene SBR	Polyacrylate ACM	Polyurethane AU, EU	Butyl IIR	Butadiene BR	Isoprene IR	Natural Rubber NR	Hypalon CSM	Fluorosilicone FVMQ	Silicone MQ, VMQ, PVMQ
Steam, 400° - 500°F	E0962-90	4	4	3	4	1	1	X	4	4	4	4	4	4	4	4	4	4	4
Steam, Above 500°F	FF200-75	X	X	X	X	1	1	X	X	X	X	X	X	X	X	X	X	X	X
Stearic Acid	N0674-70	2	2	2	X	1	1	X	2	2	X	X	2	2	2	2	2	X	2
Stoddard Solvent	N0674-70	1	1	4	1	1	1	X	2	4	1	1	4	4	4	4	4	1	4
Strontium Acetate	E0540-80	3	3	1	3	1	1	X	1	1	4	4	1	1	1	1	1	1	2
Strontium Carbonate	E0540-80	3	3	1	3	1	1	X	1	1	4	4	1	1	1	1	1	1	2
Strontium Chloride	E0540-80	3	3	1	3	1	1	X	1	1	4	4	1	1	1	1	1	1	2
Strontium Hydroxide	E0540-80	3	3	1	3	1	1	X	1	1	4	4	1	1	1	1	1	1	2
Strontium Nitrate	E0540-80	3	3	1	3	1	1	X	1	1	4	4	1	1	1	1	1	1	2
Styrene (Monomer)	V1164-75	4	4	4	2	1	1	X	4	4	4	X	4	4	4	4	4	3	4
Succinic Acid	E0540-80	3	3	1	3	1	1	X	1	1	4	4	1	1	1	1	1	1	2
Sucrose Solutions	N0674-70	1	1	1	1	1	1	X	2	1	4	4	1	1	1	1	2	1	1
Sulfamic Acid	E0540-80	3	3	1	3	1	1	X	1	1	4	4	1	1	1	1	1	1	2
Sulfanilic Acid	E0540-80	3	3	1	3	1	1	X	1	1	4	4	1	1	1	1	1	1	2
Sulfanilic Chloride	V1164-75	2	2	4	1	1	1	X	4	4	4	3	4	4	4	4	4	2	X
Sulfanilimide	V1164-75	2	2	4	1	1	1	X	4	4	4	3	4	4	4	4	4	2	X
Sulfite Liquors	E0540-80	3	3	1	3	1	1	X	1	1	4	4	1	1	1	1	1	1	2
Sulfolane	E0540-80	2	2	1	2	1	1	1	2	X	X	X	X	X	X	X	X	X	X
Sulfonated Oils	V1164-75	2	2	4	1	1	1	X	4	4	4	3	4	4	4	4	4	2	X
Sulfonic Acid	E0540-80	3	3	1	3	1	1	X	1	1	4	4	1	1	1	1	1	1	2
Sulfonyl Chloride	E0540-80	3	3	1	3	2	2	X	1	1	4	4	1	1	1	1	1	1	2
Sulfur	E0540-80	4	4	1	1	1	1	X	1	4	4	X	1	4	4	4	X	1	X
Sulfur (Molten)	V1164-75	4	4	3	1	1	1	X	3	4	4	4	3	4	4	4	4	3	3
Sulfur Chloride	V1164-75	4	4	4	1	1	1	X	4	4	4	X	4	4	4	4	4	1	3
Sulfur Dioxide, Dry	E0540-80	4	4	1	4	1	1	X	4	2	4	X	2	2	2	2	4	2	2
Sulfur Dioxide, Liquidified under pressure	E0540-80	4	4	1	4	1	1	X	4	4	4	X	2	4	4	4	4	2	2
Sulfur Dioxide, Wet	E0540-80	4	4	1	4	1	1	X	2	4	4	X	1	4	4	4	3	2	2
Sulfur Hexafluoride	E0540-80	2	2	1	3	2	2	3	1	X	X	X	X	X	X	X	X	X	X
Sulfur Liquors	V0834-70	2	2	2	1	1	1	X	2	2	4	X	2	2	2	2	2	2	4
Sulfur Monochloride	N0674-70	1	1	4	1	1	1	X	2	4	1	1	4	4	4	4	2	1	2
Sulfur Tetrafluoride	V3819-75	X	X	X	X	2	2	X	X	X	X	X	X	X	X	X	X	X	X
Sulfur Trioxide Dry	V1164-75	4	4	2	1	1	1	X	4	3	4	X	2	2	2	2	4	2	2
Sulfuric Acid (20% Oleum)	E0540-80	3	3	1	3	1	1	X	1	1	4	4	1	1	1	1	1	1	2
Sulfuric Acid, 3 Molar to 158°F	E0540-80	2	2	1	1	1	1	X	2	3	2	4	1	X	X	X	1	1	1
Sulfuric Acid, Concentrated Room Temp	V1164-75	X	X	3	1	1	1	X	X	X	3	X	X	X	X	X	X	X	X
Sulfuric Acid, Concentrated to 158°F	V1164-75	4	X	4	1	1	1	X	4	4	4	4	X	X	X	X	X	4	4
Sulfuric Chlorohydrin (Chlorosulfonic Acid)	E0540-80	3	3	1	3	1	1	X	1	1	4	4	1	1	1	1	1	1	2
Sulfurous Acid	V1164-75	2	2	2	1	1	1	X	2	2	4	3	2	2	2	2	1	X	4
Sunoco #3661	N0674-70	1	1	4	1	1	1	X	2	4	1	1	4	4	4	4	2	1	4
Sunoco All purpose grease	N0674-70	1	1	4	1	1	1	X	2	4	1	1	4	4	4	4	2	1	4

Approximate Service Temperature Ranges for Commonly Used Basic Polymer Types*

Nitrile (General Service)	-34°C to 121°C (-30°F to 250°F)*	AFLAS	-9°C to 232°C (15°F to 450°F)*
Nitrile (Low Temperature)	-55°C to 107°C (-65°F to 225°F)*	Neoprene	-51°C to 107°C (-60°F to 225°F)*
Hydrogenated Nitrile	-32°C to 149°C (-23°F to 300°F)*	Polyacrylate	-21°C to 177°C (-5°F to 350°F)*
Ethylene Propylene	-57°C to 121°C (-70°F to 250°F)*	Polyurethane	-40°C to 82°C (-40°F to 180°F)*
Fluorocarbon	-26°C to 205°C (-15°F to 400°F)*	Butyl	-59°C to 120°C (-75°F to 250°F)*
Hifluor	-26°C to 205°C (-15°F to 400°F)*	Fluorosilicone	-73°C to 177°C (-100°F to 350°F)*
Perfluoroelastomer (Parofluor)	-26°C to 320°C (-15°F to 608°F)*	Silicone	-115°C to 232°C (-175°F to 450°F)*

NOTE: *These temperature ranges will apply to the majority of media for which the material is potentially recommended. With some media however, the service temperature range may be significantly different. ALWAYS TEST UNDER ACTUAL SERVICE CONDITIONS.

WARNING: These products can expose you to chemicals including carbon black (airborne and extracts), antimony trioxide, titanium dioxide, silica (crystalline), di(2-ethylhexyl) phthalate, ethylene thiourea, acrylonitrile, 1,3-butadiene, epichlorohydrin, toluenediisocyanate, tetrafluoroethylene, ethylbenzene, formaldehyde, furfuryl alcohol, glass fibers, methyl isobutyl ketone, nickel (metallic and compounds), lead and lead compounds which are known to the State of California to cause cancer; and 1,3-butadiene, epichlorohydrin, di(2-ethylhexyl)phthalate, di-isodecyl phthalate, ethylene thiourea, methyl isobutyl ketone, methanol, toluene, lead and lead compounds which are known to the State of California to cause birth defects and other reproductive harm. For more information go to www.P65Warnings.ca.gov.

COMPOUND COMPATIBILITY RATING
 1 - Satisfactory
 2 - Fair (usually OK for static seal)
 3 - Doubtful (sometimes OK for static seal)
 4 - Unsatisfactory
 x - Insufficient Data

	Recommended	Nitrile NBR	Hydrogenated Nitrile HNBR	Ethylene Propylene EPDM	Fluorocarbon FKM	Hifluor FKM	Perfluoroelastomer FFKM	Aflas (TFE/Propylene) FEPDM	Neoprene/Chloroprene CR	Styrene-Butadiene SBR	Polyacrylate ACM	Polyurethane AU, EU	Butyl IIR	Butadiene BR	Isoprene IR	Natural Rubber NR	Hypalon CSM	Fluorosilicone FVMQ	Silicone MQ, VMQ, PVMQ
Sunoco SAE 10	N0674-70	1	1	4	1	1	1	X	2	4	1	1	4	4	4	4	2	1	4
Sunsafe (Fire resist. hydr. fluid)	N0674-70	1	1	4	1	1	1	X	2	4	4	4	4	4	4	4	2	1	X
Super Shell Gas	N1500-75	1	1	4	1	1	1	X	2	4	2	2	4	4	4	4	4	2	4
Surfuryl Chloride	E0540-80	3	3	1	3	1	1	X	1	1	4	4	1	1	1	1	1	1	2
Swan Finch EP Lube	N0674-70	1	1	4	1	1	1	X	4	4	1	1	4	4	4	4	4	1	4
Swan Finch Hypoid-90	N0674-70	1	1	4	1	1	1	X	2	4	1	1	4	4	4	4	4	1	4
- T -																			
Tallow	N0674-70	1	1	4	1	1	1	X	2	4	1	1	4	4	4	4	2	1	2
Tannic Acid (10%)	N0674-70	1	1	1	1	1	1	X	1	2	4	X	1	1	1	1	1	1	2
Tar, bituminous	V1164-75	2	2	4	1	1	1	X	3	4	4	X	4	4	2	3	4	1	2
Tartaric Acid	N0674-70	1	1	2	1	1	1	X	2	4	X	1	2	2	1	3	1	1	1
Tellone II	V3819-75	X	X	X	X	1	1	X	X	X	X	X	X	X	X	X	X	X	X
Terephthalic Acid	E0540-80	3	3	1	3	1	1	X	1	1	4	4	1	1	1	1	1	1	2
Terpineol	V1164-75	2	2	3	1	1	1	X	4	4	X	2	3	4	4	4	4	1	X
Terpinyl Acetate	V1164-75	2	2	4	1	1	1	X	4	4	4	3	4	4	4	4	4	2	X
Tertiary Amyl Methyl Ether (TAME)	V3819-75	X	X	X	X	2	1	X	X	X	X	X	X	X	X	X	X	X	X
Tertiary Butyl Catechol or p-tert-butylcatechol	V1164-75	4	4	2	1	1	1	X	2	2	4	4	2	2	4	4	2	1	X
Tertiary Butyl Mercaptan	V1164-75	4	4	4	1	1	1	X	X	X	X	X	X	X	X	X	X	X	X
Tetrabromoethane	V1164-75	4	4	4	1	1	1	X	4	4	4	X	4	4	4	4	4	2	4
Tetrabromomethane	V1164-75	2	2	4	1	1	1	X	4	4	4	3	4	4	4	4	4	2	X
Tetrabutyl Titanate	E0540-80	2	2	1	1	1	1	X	2	2	X	X	2	2	2	2	4	4	4
Tetrachloroethylene	V1164-75	4	4	4	1	1	1	X	4	4	4	4	4	4	4	4	4	2	4
Tetrachoroethane	V1164-75	4	4	4	1	1	1	X	4	4	4	4	4	4	4	4	4	2	X
Tetraethyl Lead	V1164-75	2	2	4	1	1	1	X	2	4	X	X	4	4	4	4	4	2	X
Tetraethyl Lead "Blend"	V1164-75	2	2	4	1	1	1	X	4	4	X	X	4	4	4	4	4	2	X
Tetraethyl Orthosilicate (TEOS)	V3819-75	X	X	X	X	1	1	X	X	X	X	X	X	X	X	X	X	X	X
Tetrahydrofuran	FF500-75	4	4	2	4	1	1	X	4	4	4	3	2	4	4	4	4	4	4
Tetrahydrothiophen	V1164-75	X	X	X	X	X	X	X	X	X	X	X	X	X	X	X	X	X	X
Tetralin	V1164-75	4	4	4	1	1	1	X	4	4	X	X	4	4	4	4	4	1	4
Tetramethyl Ammonium Hydroxide	E0540-80	3	3	1	3	1	1	X	1	1	4	4	1	1	1	1	1	X	2
Tetramethylcyclotetrasiloxane (TMCTS)	V3819-75	X	X	X	X	1	1	X	X	X	X	X	X	X	X	X	X	X	X
Tetramethyldihydropyridine	V1164-75	2	2	4	1	1	1	X	4	4	4	3	4	4	4	4	4	2	X
Tetraphosphoglucosate	E0540-80	3	3	1	3	1	1	X	1	1	4	4	1	1	1	1	1	1	2
Tetraphosphoric Acid	V3819-75	X	X	X	X	1	1	X	X	X	X	X	X	X	X	X	X	X	X
Tetrasodium Pyrophosphate	E0540-80	X	X	X	X	X	X	X	X	X	X	X	X	X	X	X	X	X	X
Texaco 3450 Gear Oil	N0674-70	1	1	4	1	1	1	X	4	4	1	1	4	4	4	4	4	1	4
Texaco Capella A and AA	N0674-70	1	1	4	1	1	1	X	2	4	1	2	4	4	4	4	4	1	4

Approximate Service Temperature Ranges for Commonly Used Basic Polymer Types*

Nitrile (General Service)	-34°C to 121°C (-30°F to 250°F)*	AFLAS	-9°C to 232°C (15°F to 450°F)*
Nitrile (Low Temperature)	-55°C to 107°C (-65°F to 225°F)*	Neoprene	-51°C to 107°C (-60°F to 225°F)*
Hydrogenated Nitrile	-32°C to 149°C (-23°F to 300°F)*	Polyacrylate	-21°C to 177°C (-5°F to 350°F)*
Ethylene Propylene	-57°C to 121°C (-70°F to 250°F)*	Polyurethane	-40°C to 82°C (-40°F to 180°F)*
Fluorocarbon	-26°C to 205°C (-15°F to 400°F)*	Butyl	-59°C to 120°C (-75°F to 250°F)*
Hifluor	-26°C to 205°C (-15°F to 400°F)*	Fluorosilicone	-73°C to 177°C (-100°F to 350°F)*
Perfluoroelastomer (Parofluor)	-26°C to 320°C (-15°F to 608°F)*	Silicone	-115°C to 232°C (-175°F to 450°F)*

NOTE: *These temperature ranges will apply to the majority of media for which the material is potentially recommended. With some media however, the service temperature range may be significantly different. ALWAYS TEST UNDER ACTUAL SERVICE CONDITIONS.

WARNING: These products can expose you to chemicals including carbon black (airborne and extracts), antimony trioxide, titanium dioxide, silica (crystalline), di(2-ethylhexyl) phthalate, ethylene thiourea, acrylonitrile, 1,3-butadiene, epichlorohydrin, toluenediisocyanate, tetrafluoroethylene, ethylbenzene, formaldehyde, furfuryl alcohol, glass fibers, methyl isobutyl ketone, nickel (metallic and compounds), lead and lead compounds which are known to the State of California to cause cancer; and 1,3-butadiene, epichlorohydrin, di(2-ethylhexyl)phthalate, di-isodecyl phthalate, ethylene thiourea, methyl isobutyl ketone, methanol, toluene, lead and lead compounds which are known to the State of California to cause birth defects and other reproductive harm. For more information go to www.P65Warnings.ca.gov.

COMPOUND COMPATIBILITY RATING
 1 - Satisfactory
 2 - Fair (usually OK for static seal)
 3 - Doubtful (sometimes OK for static seal)
 4 - Unsatisfactory
 x - Insufficient Data

	Recommended	Nitrile NBR	Hydrogenated Nitrile HNBR	Ethylene Propylene EPDM	Fluorocarbon FKM	Hifluor FKM	Perfluoroelastomer FFKM	Aflas (TFE/Propylene) FEPDM	Neoprene/Chloroprene CR	Styrene-Butadiene SBR	Polyacrylate ACM	Polyurethane AU, EU	Butyl IIR	Butadiene BR	Isoprene IR	Natural Rubber NR	Hypalon CSM	Fluorosilicone FVMQ	Silicone MQ, VMQ, PVMQ
Texaco Meropa 220 (No Lead)	N0674-70	1	1	4	1	1	1	X	2	4	1	2	4	4	4	4	4	1	4
Texaco Regal B	N0674-70	1	1	4	1	1	1	X	4	4	1	1	4	4	4	4	4	1	4
Texaco Uni-Temp Grease	N0674-70	1	1	4	1	1	1	X	2	4	1	1	4	4	4	4	4	1	2
Texamatic "A" 1581 Fluid	N0674-70	1	1	4	1	1	1	X	2	4	1	2	4	4	4	4	4	2	4
Texamatic "A" 3401 Fluid	N0674-70	1	1	4	1	1	1	X	2	4	1	2	4	4	4	4	4	2	4
Texamatic "A" 3525 Fluid	N0674-70	1	1	4	1	1	1	X	2	4	1	2	4	4	4	4	4	2	4
Texamatic "A" 3528 Fluid	N0674-70	1	1	4	1	1	1	X	2	4	1	2	4	4	4	4	4	2	4
Texamatic "A" Transmission Oil	N0674-70	1	1	4	1	1	1	X	2	4	1	2	4	4	4	4	4	2	4
Texas 1500 Oil	N0674-70	1	1	4	1	1	1	X	2	4	1	1	4	4	4	4	4	1	2
Therminol 44	V1164-75	4	4	4	1	1	1	X	4	X	4	X	4	X	X	X	X	X	4
Therminol 55	V1164-75	2	2	4	1	1	1	X	4	X	2	X	4	X	X	X	X	X	4
Therminol 66	V3819-75	X	X	X	X	1	1	X	X	X	X	X	X	X	X	X	X	X	X
Therminol FR	V3819-75	X	X	X	X	1	1	X	X	X	X	X	X	X	X	X	X	X	X
Therminol VP-1, 60, 65	V1164-75	4	4	4	1	1	1	X	4	X	4	X	4	X	X	X	X	X	2
Thio Acid Chloride	V3819-75	X	X	X	X	1	1	X	X	X	X	X	X	X	X	X	X	X	X
Thioamyl Alcohol	N0674-70	1	1	4	1	1	1	X	2	4	1	1	4	4	4	4	2	1	2
Thiodiacetic Acid	E0540-80	3	3	1	3	1	1	X	1	1	4	4	1	1	1	1	1	1	2
Thioethanol	E0540-80	3	3	1	3	1	1	X	1	1	4	4	1	1	1	1	1	1	2
Thioglycolic Acid	E0540-80	3	3	1	3	1	1	X	1	1	4	4	1	1	1	1	1	1	2
Thiokol TP-90B	E0540-80	4	4	1	1	1	1	X	2	4	X	X	1	X	X	X	2	2	X
Thiokol TP-95	E0540-80	4	4	1	1	1	1	X	2	4	X	X	1	X	X	X	2	2	X
Thionyl Chloride	V1164-75	2	2	4	1	1	1	X	4	4	4	3	4	4	4	4	4	2	X
Thiophene (Thiofuran)	V1164-75	2	2	4	1	1	1	X	4	4	4	3	4	4	4	4	4	2	X
Thiophosphoryl Chloride	E0540-80	3	3	1	3	1	1	X	1	1	4	4	1	1	1	1	1	1	2
Thiourea	E0540-80	3	3	1	3	1	1	X	1	1	4	4	1	1	1	1	1	1	2
Thorium Nitrate	E0540-80	3	3	1	3	1	1	X	1	1	4	4	1	1	1	1	1	1	2
Tidewater Multigear, 140 EP Lube	N0674-70	1	1	4	1	1	1	X	2	4	1	1	4	4	4	4	2	1	4
Tidewater Oil-Beedol	N0674-70	1	1	4	1	1	1	X	2	4	1	1	4	4	4	4	4	1	2
Tin Ammonium Chloride	E0540-80	3	3	1	3	1	1	X	1	1	4	4	1	1	1	1	1	1	2
Tin Chloride	N0674-70	1	1	4	1	1	1	X	2	4	1	1	4	4	4	4	2	1	2
Tin Tetrachloride	N0674-70	1	1	4	1	1	1	X	2	4	1	1	4	4	4	4	2	1	2
Titanic Acid	E0540-80	3	3	1	3	1	1	X	1	1	4	4	1	1	1	1	1	1	2
Titanium Chloride	V1164-75	X	X	X	X	X	X	X	X	X	X	X	X	X	X	X	X	X	X
Titanium Dioxide	E0540-80	3	3	1	3	1	1	X	1	1	4	4	1	1	1	1	1	1	2
Titanium Sulfate	E0540-80	3	3	1	3	1	1	X	1	1	4	4	1	1	1	1	1	1	2
Titanium Tetrachloride	V1164-75	2	2	4	1	1	1	X	4	4	4	4	4	4	4	4	4	2	4
Toluene	V1164-75	4	4	4	1	2	1	X	4	4	4	4	4	4	4	4	4	2	4
Toluene Bisodium Sulfite	V3819-75	X	X	X	X	1	1	X	X	X	X	X	X	X	X	X	X	X	X
Toluene Diisocyanate (TDI)	E0540-80	4	4	2	4	1	1	X	4	4	4	X	2	4	4	4	4	4	4
Toluene Sulfonyl Chloride	V1164-75	2	2	4	1	1	1	X	4	4	4	3	4	4	4	4	4	2	X

Approximate Service Temperature Ranges for Commonly Used Basic Polymer Types*

Nitrile (General Service)	-34°C to 121°C (-30°F to 250°F)*	AFLAS	-9°C to 232°C (15°F to 450°F)*
Nitrile (Low Temperature)	-55°C to 107°C (-65°F to 225°F)*	Neoprene	-51°C to 107°C (-60°F to 225°F)*
Hydrogenated Nitrile	-32°C to 149°C (-23°F to 300°F)*	Polyacrylate	-21°C to 177°C (-5°F to 350°F)*
Ethylene Propylene	-57°C to 121°C (-70°F to 250°F)*	Polyurethane	-40°C to 82°C (-40°F to 180°F)*
Fluorocarbon	-26°C to 205°C (-15°F to 400°F)*	Butyl	-59°C to 120°C (-75°F to 250°F)*
Hifluor	-26°C to 205°C (-15°F to 400°F)*	Fluorosilicone	-73°C to 177°C (-100°F to 350°F)*
Perfluoroelastomer (Parofluor)	-26°C to 320°C (-15°F to 608°F)*	Silicone	-115°C to 232°C (-175°F to 450°F)*

NOTE: *These temperature ranges will apply to the majority of media for which the material is potentially recommended. With some media however, the service temperature range may be significantly different. ALWAYS TEST UNDER ACTUAL SERVICE CONDITIONS.

WARNING: These products can expose you to chemicals including carbon black (airborne and extracts), antimony trioxide, titanium dioxide, silica (crystalline), di(2-ethylhexyl) phthalate, ethylene thiourea, acrylonitrile, 1,3-butadiene, epichlorohydrin, toluenediisocyanate, tetrafluoroethylene, ethylbenzene, formaldehyde, furfuryl alcohol, glass fibers, methyl isobutyl ketone, nickel (metallic and compounds), lead and lead compounds which are known to the State of California to cause cancer; and 1,3-butadiene, epichlorohydrin, di(2-ethylhexyl)phthalate, di-isodecyl phthalate, ethylene thiourea, methyl isobutyl ketone, methanol, toluene, lead and lead compounds which are known to the State of California to cause birth defects and other reproductive harm. For more information go to www.P65Warnings.ca.gov.

COMPOUND COMPATIBILITY RATING
 1 - Satisfactory
 2 - Fair (usually OK for static seal)
 3 - Doubtful (sometimes OK for static seal)
 4 - Unsatisfactory
 x - Insufficient Data

	Recommended	Nitrile NBR	Hydrogenated Nitrile HNBR	Ethylene Propylene EPDM	Fluorocarbon FKM	Hifluor FKM	Perfluoroelastomer FFKM	Aflas (TFE/Propylene) FFKM	Neoprene/Chloroprene CR	Styrene-Butadiene SBR	Polyacrylate ACM	Polyurethane AU, EU	Butyl IIR	Butadiene BR	Isoprene IR	Natural Rubber NR	Hypalon CSM	Fluorosilicone FVMQ	Silicone MQ, VMQ, PVMQ
Toluenesulfonic Acid	E0540-80	3	3	1	3	1	1	X	1	1	4	4	1	1	1	1	1	1	2
Toluidine	V1164-75	2	2	4	1	1	1	X	4	4	4	3	4	4	4	4	4	2	X
Toluol	E0540-80	3	3	1	3	1	1	X	1	1	4	4	1	1	1	1	1	1	2
Toluquinone	V1164-75	2	2	4	1	1	1	X	4	4	4	3	4	4	4	4	4	2	X
Tolylaldehyde	E0540-80	3	3	1	3	1	1	X	1	1	4	4	1	1	1	1	1	1	2
Toothpaste	E3609-70	1	1	1	1	1	1	1	1	1	2	3	1	1	1	1	1	1	1
Transformer Oil	N0674-70	1	1	4	1	1	1	X	2	4	2	1	4	4	4	4	4	1	2
Transmission Fluid Type A	N0674-70	1	1	4	1	1	1	X	2	4	1	1	4	4	4	4	2	1	2
Triacetin	E0540-80	2	2	1	4	1	1	X	2	3	4	4	1	2	2	2	2	4	X
Triaryl Phosphate	E0540-80	4	4	1	1	1	1	X	4	4	4	4	1	4	4	4	4	2	3
Tribromomethylbenzene	V1164-75	2	2	4	1	1	1	X	4	4	4	3	4	4	4	4	4	2	X
Tributoxyethyl Phosphate	E0540-80	4	4	1	1	1	1	X	4	2	4	4	1	2	4	2	4	2	X
Tributyl Citrate	E0540-80	3	3	1	3	1	1	X	1	1	4	4	1	1	1	1	1	1	2
Tributyl Mercaptan	V1164-75	4	4	4	1	1	1	X	4	4	4	X	4	4	4	4	4	3	4
Tributyl Phosphate	E0540-80	4	4	1	4	1	1	X	4	4	4	4	2	4	2	2	4	4	4
Tributylamine	FF500-75	X	X	X	X	1	1	X	X	X	X	X	X	X	X	X	X	X	X
Trichloroacetic Acid	E0540-80	2	2	2	3	1	1	X	4	2	4	4	2	2	2	2	4	4	X
Trichloroacetyl Chloride	V1164-75	2	2	4	1	1	1	X	4	4	4	3	4	4	4	4	4	2	X
Trichlorobenzene	V1164-75	2	2	4	1	1	1	X	4	4	4	3	4	4	4	4	4	2	X
Trichloroethane	V1164-75	4	4	4	1	1	1	X	4	4	4	4	4	4	4	4	4	2	4
Trichloroethanolamine	E0540-80	3	3	1	3	1	1	X	1	1	4	4	1	1	1	1	1	1	2
Trichloroethylene	V1164-75	3	3	4	1	1	1	X	4	4	4	4	4	4	4	4	4	2	4
Trichloromethane	V1164-75	4	4	4	1	1	1	X	4	4	4	4	4	4	4	4	4	2	4
Trichloronitromethane (Chloropicrin)	E0540-80	3	3	1	3	1	1	X	1	1	4	4	1	1	1	1	1	1	2
Trichlorophenylsilane	V3819-75	X	X	X	X	1	1	X	X	X	X	X	X	X	X	X	X	X	X
Trichloropropane	V1164-75	4	4	4	1	1	1	X	4	4	4	4	4	4	4	4	4	2	4
Trichlorosilane	V1164-75	4	4	4	1	1	1	X	4	4	4	4	4	4	4	4	4	2	4
Tricresyl Phosphate	E0540-80	4	4	1	2	1	1	X	3	2	4	4	1	4	4	4	4	2	3
Triethanol Amine	E0540-80	3	3	2	4	1	1	X	2	2	4	4	2	2	2	2	2	4	X
Triethyl Phosphate	V1164-75	2	2	4	1	1	1	X	4	4	4	3	4	4	4	4	4	2	X
Triethylaluminum	V3819-75	X	X	X	X	1	1	X	X	X	X	X	X	X	X	X	X	X	X
Triethylborane	V3819-75	X	X	X	X	1	1	X	X	X	X	X	X	X	X	X	X	X	X
Triethylene Glycol	E0540-80	3	3	1	3	1	1	X	1	1	4	4	1	1	1	1	1	1	2
Triethylenetetramine	E0540-80	3	3	1	3	1	1	X	1	1	4	4	1	1	1	1	1	1	2
Trifluoroacetic Acid	E0540-80	3	3	1	3	2	2	X	1	1	4	4	1	1	1	1	1	1	2
Trifluoroethane (R-23)	V1164-75	4	4	4	1	1	1	X	4	4	4	4	4	4	4	4	4	2	4
Trifluoromethane	V1164-75	4	4	4	1	1	1	X	4	4	4	4	4	4	4	4	4	2	4
Trifluorovinylchloride	V1164-75	2	2	4	1	1	1	X	4	4	4	3	4	4	4	4	4	2	X
Triisopropylbenzylchloride	V1164-75	2	2	4	1	1	1	X	4	4	4	3	4	4	4	4	4	2	X
Trimethylamine (TMA)	E0540-80	3	3	1	3	1	1	X	1	1	4	4	1	1	1	1	1	1	2

Approximate Service Temperature Ranges for Commonly Used Basic Polymer Types*

Nitrile (General Service)	-34°C to 121°C (-30°F to 250°F)*	AFLAS	-9°C to 232°C (15°F to 450°F)*
Nitrile (Low Temperature)	-55°C to 107°C (-65°F to 225°F)*	Neoprene	-51°C to 107°C (-60°F to 225°F)*
Hydrogenated Nitrile	-32°C to 149°C (-23°F to 300°F)*	Polyacrylate	-21°C to 177°C (-5°F to 350°F)*
Ethylene Propylene	-57°C to 121°C (-70°F to 250°F)*	Polyurethane	-40°C to 82°C (-40°F to 180°F)*
Fluorocarbon	-26°C to 205°C (-15°F to 400°F)*	Butyl	-59°C to 120°C (-75°F to 250°F)*
Hifluor	-26°C to 205°C (-15°F to 400°F)*	Fluorosilicone	-73°C to 177°C (-100°F to 350°F)*
Perfluoroelastomer (Parofluor)	-26°C to 320°C (-15°F to 608°F)*	Silicone	-115°C to 232°C (-175°F to 450°F)*

NOTE: *These temperature ranges will apply to the majority of media for which the material is potentially recommended. With some media however, the service temperature range may be significantly different. ALWAYS TEST UNDER ACTUAL SERVICE CONDITIONS.

WARNING: These products can expose you to chemicals including carbon black (airborne and extracts), antimony trioxide, titanium dioxide, silica (crystalline), di(2-ethylhexyl) phthalate, ethylene thiourea, acrylonitrile, 1,3-butadiene, epichlorohydrin, toluenediisocyanate, tetrafluoroethylene, ethylbenzene, formaldehyde, furfuryl alcohol, glass fibers, methyl isobutyl ketone, nickel (metallic and compounds), lead and lead compounds which are known to the State of California to cause cancer; and 1,3-butadiene, epichlorohydrin, di(2-ethylhexyl)phthalate, di-isodecyl phthalate, ethylene thiourea, methyl isobutyl ketone, methanol, toluene, lead and lead compounds which are known to the State of California to cause birth defects and other reproductive harm. For more information go to www.P65Warnings.ca.gov.

Compatibility Tables for Gases, Fluids, Solids

COMPOUND COMPATIBILITY RATING
 1 - Satisfactory
 2 - Fair (usually OK for static seal)
 3 - Doubtful (sometimes OK for static seal)
 4 - Unsatisfactory
 x - Insufficient Data

	Recommended	Nitrile NBR	Hydrogenated Nitrile HNBR	Ethylene Propylene EPDM	Fluorocarbon FKM	Hifluor FKM	Perfluoroelastomer FFKM	Aflas (TFE/Propylene) FFKM	Neoprene/Chloroprene CR	Styrene-Butadiene SBR	Polyacrylate ACM	Polyurethane AU, EU	Butyl IIR	Butadiene BR	Isoprene IR	Natural Rubber NR	Hypalon CSM	Fluorosilicone FVMQ	Silicone MQ, VMQ, PVMQ
Trimethylbenzene	V1164-75	2	2	4	1	1	1	X	4	4	4	3	4	4	4	4	4	2	X
Trimethylborate (TMB)	V1164-75	2	2	4	1	1	1	X	4	4	4	3	4	4	4	4	4	2	X
Trimethylpentane	N0674-70	1	1	4	1	1	1	X	2	4	1	1	4	4	4	4	2	1	2
Trinitrolozene (TNT)	V1164-75	4	4	4	2	1	1	X	2	4	4	X	4	4	4	4	2	2	X
Trioctyl Phosphate	E0540-80	4	4	1	2	1	1	X	4	4	4	4	1	4	4	4	4	2	3
Triphenylphosphite	E0540-80	3	3	1	3	1	1	X	1	1	4	4	1	1	1	1	1	1	2
Tripoly Phosphate	E0540-80	4	4	1	2	1	1	X	3	4	4	4	1	4	4	4	4	1	3
Tripotassium Phosphate	E0540-80	3	3	1	3	1	1	X	1	1	4	4	1	1	1	1	1	1	2
Trisodium Phosphate	E0540-80	3	3	1	3	1	1	X	1	1	4	4	1	1	1	1	1	1	2
Tritium	Factory	X	X	X	X	X	X	X	X	X	X	X	X	X	X	X	X	X	X
Tung Oil (China Wood Oil)	N0674-70	1	1	4	1	1	1	X	2	4	X	3	3	4	4	4	3	2	4
Tungsten Hexafluoride	V3819-75	X	X	X	X	2	2	X	X	X	X	X	X	X	X	X	X	X	X
Tungstic Acid	V3819-75	X	X	X	X	1	1	X	X	X	X	X	X	X	X	X	X	X	X
Turbine Oil	N0674-70	1	1	4	1	1	1	X	4	4	1	1	4	4	4	4	4	1	4
Turbine Oil #15 (MIL-L-7808A)	V1164-75	2	2	4	1	1	1	X	4	4	2	4	4	4	4	4	4	2	4
Turbo Oil #35	N0674-70	1	1	4	1	1	1	X	2	4	1	1	4	4	4	4	4	1	4
Turpentine	N0674-70	1	1	4	1	1	1	X	4	4	2	4	4	4	4	4	4	2	4
Type I Fuel (MIL-S-3136)(ASTM Ref. Fuel A)	N0602-70	1	1	4	1	1	1	X	2	4	1	1	4	4	4	4	2	1	4
Type II Fuel MIL-S-3136	N0602-70	2	2	4	1	1	1	X	4	4	3	2	4	4	4	4	4	2	4
Type III Fuel MIL-S-3136(ASTM Ref. Fuel B)	N0602-70	2	2	4	1	1	1	X	4	4	3	2	4	4	4	4	4	2	4
- U -																			
Ucon Hydrolube J-4	N0674-70	1	1	1	1	1	1	X	2	1	4	4	1	2	X	X	X	2	1
Ucon Lubricant 50-HB-100	N0674-70	1	1	1	1	1	1	X	1	1	X	X	1	1	1	1	1	1	1
Ucon Lubricant 50-HB-260	N0674-70	1	1	1	1	1	1	X	1	1	X	X	1	1	1	1	1	1	1
Ucon Lubricant 50-HB-5100	N0674-70	1	1	1	1	1	1	X	1	1	X	X	1	1	1	1	1	1	1
Ucon Lubricant 50-HB55	N0674-70	1	1	1	1	1	1	X	1	1	X	X	1	1	1	1	1	1	1
Ucon Lubricant 50-HB-660	N0674-70	1	1	1	1	1	1	X	1	1	X	X	1	1	1	1	1	1	1
Ucon Lubricant LB-1145	N0674-70	1	1	1	1	1	1	X	1	1	X	X	1	1	1	1	1	1	1
Ucon Lubricant LB-135	N0674-70	1	1	1	1	1	1	X	1	1	X	X	1	1	1	1	1	1	1
Ucon Lubricant LB-285	N0674-70	1	1	1	1	1	1	X	1	1	X	X	1	1	1	1	1	1	1
Ucon Lubricant LB-300X	N0674-70	1	1	1	1	1	1	X	1	1	X	X	1	1	1	1	1	1	1
Ucon Lubricant LB-625	N0674-70	1	1	1	1	1	1	X	1	1	X	X	1	1	1	1	1	1	1
Ucon Lubricant LB-65	N0674-70	1	1	1	1	1	1	X	1	2	X	X	1	2	2	2	2	1	1
Ucon Oil 50-HB-280x	E0540-80	2	2	1	3	1	1	2	X	X	X	X	X	X	X	X	X	X	X
Ucon Oil Heat Transfer Fluid 500 (Polyalkylene Glycol)	N0674-70	1	1	1	1	1	1	X	1	1	X	X	1	1	1	1	1	1	1
Ucon Oil LB-385	N0674-70	1	1	1	1	1	1	X	1	1	X	X	1	1	1	1	1	1	1
Ucon Oil LB-400X	N0674-70	1	1	1	1	1	1	X	1	1	X	X	1	1	1	1	1	1	1
Undecylenic Acid	V1164-75	2	2	4	1	1	1	X	4	4	4	3	4	4	4	4	4	2	X
Undecylic Acid	V1164-75	2	2	4	1	1	1	X	4	4	4	3	4	4	4	4	4	2	X
Univis 40 (Hydr. Fluid)	N0674-70	1	1	4	1	1	1	X	2	4	1	1	4	4	4	4	2	1	4
Univolt #35 (Mineral Oil)	N0674-70	1	1	4	1	1	1	X	2	4	1	1	4	4	4	4	4	1	4

Approximate Service Temperature Ranges for Commonly Used Basic Polymer Types*

Nitrile (General Service)	-34°C to 121°C (-30°F to 250°F)*	AFLAS	-9°C to 232°C (15°F to 450°F)*
Nitrile (Low Temperature)	-55°C to 107°C (-65°F to 225°F)*	Neoprene	-51°C to 107°C (-60°F to 225°F)*
Hydrogenated Nitrile	-32°C to 149°C (-23°F to 300°F)*	Polyacrylate	-21°C to 177°C (-5°F to 350°F)*
Ethylene Propylene	-57°C to 121°C (-70°F to 250°F)*	Polyurethane	-40°C to 82°C (-40°F to 180°F)*
Fluorocarbon	-26°C to 205°C (-15°F to 400°F)*	Butyl	-59°C to 120°C (-75°F to 250°F)*
Hifluor	-26°C to 205°C (-15°F to 400°F)*	Fluorosilicone	-73°C to 177°C (-100°F to 350°F)*
Perfluoroelastomer (Parofluor)	-26°C to 320°C (-15°F to 608°F)*	Silicone	-115°C to 232°C (-175°F to 450°F)*

NOTE: *These temperature ranges will apply to the majority of media for which the material is potentially recommended. With some media however, the service temperature range may be significantly different. ALWAYS TEST UNDER ACTUAL SERVICE CONDITIONS.



WARNING: These products can expose you to chemicals including carbon black (airborne and extracts), antimony trioxide, titanium dioxide, silica (crystalline), di(2-ethylhexyl) phthalate, ethylene thiourea, acrylonitrile, 1,3-butadiene, epichlorohydrin, toluenediisocyanate, tetrafluoroethylene, ethylbenzene, formaldehyde, furfuryl alcohol, glass fibers, methyl isobutyl ketone, nickel (metallic and compounds), lead and lead compounds which are known to the State of California to cause cancer; and 1,3-butadiene, epichlorohydrin, di(2-ethylhexyl)phthalate, di-isodecyl phthalate, ethylene thiourea, methyl isobutyl ketone, methanol, toluene, lead and lead compounds which are known to the State of California to cause birth defects and other reproductive harm. For more information go to www.P65Warnings.ca.gov.

COMPOUND COMPATIBILITY RATING
 1 - Satisfactory
 2 - Fair (usually OK for static seal)
 3 - Doubtful (sometimes OK for static seal)
 4 - Unsatisfactory
 x - Insufficient Data

	Recommended	Nitrile NBR	Hydrogenated Nitrile HNBR	Ethylene Propylene EPDM	Fluorocarbon FKM	Hifluor FKM	Perfluoroelastomer FFKM	Aflas (TFE/Propylene) FEPDM	Neoprene/Chloroprene CR	Styrene-Butadiene SBR	Polyacrylate ACM	Polyurethane AU, EU	Butyl IIR	Butadiene BR	Isoprene IR	Natural Rubber NR	Hypalon CSM	Fluorosilicone FVMQ	Silicone MQ, VMQ, PVMQ
Unsymmetrical Dimethyl Hydrazine (UDMH)	E0540-80	2	2	1	4	1	1	X	2	2	X	X	1	1	1	1	1	4	4
UPDI(Ultrapur Deionized Water)	E0540-80	3	3	1	3	1	1	X	1	1	4	4	1	1	1	1	1	1	2
Uranium Hexachloride	V1164-75	X	X	X	1	1	1	X	X	X	X	X	X	X	X	X	X	X	X
Uranium Hexafluoride	Factory	X	X	X	X	X	X	X	X	X	X	X	X	X	X	X	X	X	X
Uranium Sulfate	Factory	X	X	X	X	X	X	X	X	X	X	X	X	X	X	X	X	X	X
Uric Acid	E0540-80	3	3	1	3	1	1	X	1	1	4	4	1	1	1	1	1	3	2
- V -																			
Valeraldehyde	E0540-80	3	3	1	3	1	1	X	1	1	4	4	1	1	1	1	1	1	2
Valeric Acid	E0540-80	3	3	1	3	1	1	X	1	1	4	4	1	1	1	1	1	1	2
Vanadium Oxide	N0674-70	1	1	4	1	1	1	X	2	4	1	1	4	4	4	4	2	1	2
Vanadium Pentoxide	N0674-70	1	1	4	1	1	1	X	2	4	1	1	4	4	4	4	2	1	2
Varnish	V1164-75	2	2	4	1	1	1	X	4	4	4	3	4	4	4	4	4	2	4
Vegetable Oil	N0674-70	1	1	3	1	1	1	X	3	4	1	X	3	4	4	4	X	1	1
Versilube F44, F55	N0674-70	1	1	1	1	1	1	1	X	X	X	X	X	X	X	X	X	X	X
Versilube F-50	E0540-80	1	1	1	1	1	1	X	1	1	1	1	1	1	1	1	1	1	3
Vinegar	E0540-80	2	2	2	3	1	1	X	2	2	4	4	2	2	2	2	X	3	3
Vinyl Acetate	E0540-80	2	2	1	3	2	1	1	2	X	X	X	X	X	X	X	X	X	X
Vinyl Benzene	V1164-75	2	2	4	1	1	1	X	4	4	4	3	4	4	4	4	4	2	X
Vinyl Benzoate	V1164-75	2	2	4	1	1	1	X	4	4	4	3	4	4	4	4	4	2	X
Vinyl Chloride	V1164-75	2	2	4	1	1	1	X	4	4	4	3	4	4	4	4	4	2	X
Vinyl Fluoride	V1164-75	2	2	4	1	1	1	X	4	4	4	3	4	4	4	4	4	2	X
Vinylidene Chloride	V1164-75	2	2	4	1	1	1	X	4	4	4	3	4	4	4	4	4	2	X
Vinylpyridine	V1164-75	2	2	4	1	1	1	X	4	4	4	3	4	4	4	4	4	2	X
Vitriol (White)	E0540-80	3	3	1	3	1	1	X	1	1	4	4	1	1	1	1	1	1	2
VV-H-910	E0540-80	3	3	1	1	1	1	X	2	1	2	4	2	2	2	2	2	2	2
V V-L-825	C0873-70	1	X	4	X	1	1	X	1	X	1	2	4	X	X	X	X	1	3
- W -																			
Wagner 21B Brake Fluid	E0667-70	3	3	1	4	1	1	X	2	1	X	X	2	X	X	2	2	4	3
Water	E0540-80	1	2	1	2	1	1	X	2	1	4	4	1	1	1	1	1	1	1
Wemco C	N0674-70	1	1	4	1	1	1	X	2	4	1	1	4	4	4	4	4	1	4
Whiskey and Wines	E3609-70	1	1	1	1	1	1	X	1	1	4	4	1	1	1	1	1	1	1
White Liquor	N0674-70	1	1	1	1	1	1	1	1	X	X	X	X	X	X	X	X	X	X
White Oil	N0674-70	1	1	4	1	1	1	X	2	4	1	1	4	4	4	4	4	1	4
White Pine Oil	V1164-75	2	2	4	1	1	1	X	4	4	X	X	4	4	4	4	4	1	4
Wolmar Salt	N0674-70	1	1	1	1	1	1	X	2	1	2	1	1	1	1	1	1	1	1
Wood Alcohol	N0674-70	1	1	1	4	1	1	X	1	1	4	4	1	1	1	1	1	1	1
Wood Oil	N0674-70	1	1	4	1	1	1	X	2	4	1	3	3	4	4	4	3	2	4

Approximate Service Temperature Ranges for Commonly Used Basic Polymer Types*

Nitrile (General Service)	-34°C to 121°C (-30°F to 250°F)*	AFLAS	-9°C to 232°C (15°F to 450°F)*
Nitrile (Low Temperature)	-55°C to 107°C (-65°F to 225°F)*	Neoprene	-51°C to 107°C (-60°F to 225°F)*
Hydrogenated Nitrile	-32°C to 149°C (-23°F to 300°F)*	Polyacrylate	-21°C to 177°C (-5°F to 350°F)*
Ethylene Propylene	-57°C to 121°C (-70°F to 250°F)*	Polyurethane	-40°C to 82°C (-40°F to 180°F)*
Fluorocarbon	-26°C to 205°C (-15°F to 400°F)*	Butyl	-59°C to 120°C (-75°F to 250°F)*
Hifluor	-26°C to 205°C (-15°F to 400°F)*	Fluorosilicone	-73°C to 177°C (-100°F to 350°F)*
Perfluoroelastomer (Parofluor)	-26°C to 320°C (-15°F to 608°F)*	Silicone	-115°C to 232°C (-175°F to 450°F)*

NOTE: *These temperature ranges will apply to the majority of media for which the material is potentially recommended. With some media however, the service temperature range may be significantly different. ALWAYS TEST UNDER ACTUAL SERVICE CONDITIONS.

WARNING: These products can expose you to chemicals including carbon black (airborne and extracts), antimony trioxide, titanium dioxide, silica (crystalline), di(2-ethylhexyl) phthalate, ethylene thiourea, acrylonitrile, 1,3-butadiene, epichlorohydrin, toluenediisocyanate, tetrafluoroethylene, ethylbenzene, formaldehyde, furfuryl alcohol, glass fibers, methyl isobutyl ketone, nickel (metallic and compounds), lead and lead compounds which are known to the State of California to cause cancer; and 1,3-butadiene, epichlorohydrin, di(2-ethylhexyl)phthalate, di-isodecyl phthalate, ethylene thiourea, methyl isobutyl ketone, methanol, toluene, lead and lead compounds which are known to the State of California to cause birth defects and other reproductive harm. For more information go to www.P65Warnings.ca.gov.

COMPOUND COMPATIBILITY RATING
 1 - Satisfactory
 2 - Fair (usually OK for static seal)
 3 - Doubtful (sometimes OK for static seal)
 4 - Unsatisfactory
 x - Insufficient Data

	Recommended	Nitrile NBR	Hydrogenated Nitrile HNBR	Ethylene Propylene EPDM	Fluorocarbon FKM	Hifluor FKM	Perfluoroelastomer FFKM	Aflas (TFE/Propylene) FFKM	Neoprene/Chloroprene CR	Styrene-Butadiene SBR	Polyacrylate ACM	Polyurethane AU, EU	Butyl IIR	Butadiene BR	Isoprene IR	Natural Rubber NR	Hypalon CSM	Fluorosilicone FVMQ	Silicone MQ, VMQ, PVMQ
- X -																			
Xenon	N0674-70	1	1	1	1	1	1	X	1	1	1	1	1	1	1	1	1	1	1
Xylene	V1164-75	4	4	4	1	1	1	X	4	4	4	4	4	4	4	4	4	1	4
Xylenes-Mixed-Aromatic Amines	E0540-80	3	3	1	4	1	1	X	4	4	4	4	4	4	4	4	4	4	4
Xylol	V1164-75	4	4	4	1	1	1	X	4	4	4	4	4	4	4	4	4	1	4
- Z -																			
Zeolites	N0674-70	1	1	1	1	1	1	X	1	1	X	X	1	1	1	1	1	1	X
Zinc Acetate	E0540-80	2	2	1	4	1	1	X	2	4	4	4	1	4	1	1	4	4	4
Zinc Ammonium Chloride	E0540-80	3	3	1	3	1	1	X	1	1	4	4	1	1	1	1	1	1	2
Zinc Bromide Completion Fluid	V1164-75	X	X	X	X	X	X	X	X	X	X	X	X	X	X	X	X	X	X
Zinc Chloride	N0674-70	1	1	1	1	1	1	X	1	1	4	X	1	1	1	1	1	1	X
Zinc Chromate	E0540-80	3	3	1	3	1	1	X	1	1	4	4	1	1	1	1	1	1	2
Zinc Cyanide	E0540-80	3	3	1	3	1	1	X	1	1	4	4	1	1	1	1	1	1	2
Zinc Diethyldithiocarbamate	E0540-80	3	3	1	3	1	1	X	1	1	4	4	1	1	1	1	1	1	2
Zinc Dihydrogen Phosphate	E0540-80	3	3	1	3	1	1	X	1	1	4	4	1	1	1	1	1	1	2
Zinc Fluorosilicate	V3819-75	X	X	X	X	1	1	X	X	X	X	X	X	X	X	X	X	X	X
Zinc Hydrosulfite	E0540-80	3	3	1	3	1	1	X	1	1	4	4	1	1	1	1	1	1	2
Zinc Naphthenate	V3819-75	X	X	X	X	1	1	X	X	X	X	X	X	X	X	X	X	X	X
Zinc Nitrate	N0674-70	1	1	1	1	1	1	X	X	1	4	X	1	1	1	1	1	1	X
Zinc Oxide	N0674-70	1	1	1	1	1	1	X	X	1	4	X	1	1	1	1	1	1	X
Zinc Phenolsulfonate	E0540-80	3	3	1	3	1	1	X	1	1	4	4	1	1	1	1	1	1	2
Zinc Phosphate	N0674-70	1	1	1	1	1	1	X	1	1	4	1	1	1	1	1	1	1	1
Zinc Salts	N0674-70	1	1	1	1	1	1	X	1	1	4	1	1	1	1	1	1	1	1
Zinc Silicofluoride	V3819-75	X	X	X	X	1	1	X	X	X	X	X	X	X	X	X	X	X	X
Zinc Stearate	E0540-80	3	3	1	3	1	1	X	1	1	4	4	1	1	1	1	1	1	2
Zinc Sulfate	N0674-70	1	1	1	1	1	1	X	1	2	4	4	1	2	2	2	1	1	1
Zinc Sulfide	E0540-80	3	3	1	3	1	1	X	1	1	4	4	1	1	1	1	1	1	2
Zirconium Nitrate	N0674-70	1	1	1	1	1	1	X	1	2	4	4	1	2	2	2	1	1	1

Approximate Service Temperature Ranges for Commonly Used Basic Polymer Types*

Nitrile (General Service)	-34°C to 121°C (-30°F to 250°F)*	AFLAS	-9°C to 232°C (15°F to 450°F)*
Nitrile (Low Temperature)	-55°C to 107°C (-65°F to 225°F)*	Neoprene	-51°C to 107°C (-60°F to 225°F)*
Hydrogenated Nitrile	-32°C to 149°C (-23°F to 300°F)*	Polyacrylate	-21°C to 177°C (-5°F to 350°F)*
Ethylene Propylene	-57°C to 121°C (-70°F to 250°F)*	Polyurethane	-40°C to 82°C (-40°F to 180°F)*
Fluorocarbon	-26°C to 205°C (-15°F to 400°F)*	Butyl	-59°C to 120°C (-75°F to 250°F)*
Hifluor	-26°C to 205°C (-15°F to 400°F)*	Fluorosilicone	-73°C to 177°C (-100°F to 350°F)*
Perfluoroelastomer (Parofluor)	-26°C to 320°C (-15°F to 608°F)*	Silicone	-115°C to 232°C (-175°F to 450°F)*

NOTE: *These temperature ranges will apply to the majority of media for which the material is potentially recommended. With some media however, the service temperature range may be significantly different. ALWAYS TEST UNDER ACTUAL SERVICE CONDITIONS.

WARNING: These products can expose you to chemicals including carbon black (airborne and extracts), antimony trioxide, titanium dioxide, silica (crystalline), di(2-ethylhexyl) phthalate, ethylene thiourea, acrylonitrile, 1,3-butadiene, epichlorohydrin, toluenediisocyanate, tetrafluoroethylene, ethylbenzene, formaldehyde, furfuryl alcohol, glass fibers, methyl isobutyl ketone, nickel (metallic and compounds), lead and lead compounds which are known to the State of California to cause cancer; and 1,3-butadiene, epichlorohydrin, di(2-ethylhexyl)phthalate, di-isodecyl phthalate, ethylene thiourea, methyl isobutyl ketone, methanol, toluene, lead and lead compounds which are known to the State of California to cause birth defects and other reproductive harm. For more information go to www.P65Warnings.ca.gov.

Section VIII – Specifications

8.1 How To Order O-Rings and Other Parts	8-2	8.2 International O-Ring Standards and Test Methods	
8.1.1 Parker Compound Numbering System.	8-2	Germany	8-8
Table 8-2 Military Fluid		International	8-8
Specification Description.	8-3	United Kingdom	8-8
Table 8-3 Military Rubber Specifications	8-4	France	8-8
Table 8-4 AMS and NAS Rubber Specifications	8-5	Italy	8-8
Table 8-5 Compound Specifications		Sweden	8-8
for Commonly Used SAE		United States	8-8
and ASTM Specifications	8-6	8.3 Ordering Addresses	8-8

 **WARNING:** These products can expose you to chemicals including carbon black (airborne and extracts), antimony trioxide, titanium dioxide, silica (crystalline), di(2-ethylhexyl) phthalate, ethylene thiourea, acrylonitrile, 1,3-butadiene, epichlorohydrin, toluenediisocyanate, tetrafluoroethylene, ethylbenzene, formaldehyde, furfuryl alcohol, glass fibers, methyl isobutyl ketone, nickel (metallic and compounds), lead and lead compounds which are known to the State of California to cause cancer; and 1,3-butadiene, epichlorohydrin, di(2-ethylhexyl)phthalate, di-isodecyl phthalate, ethylene thiourea, methyl isobutyl ketone, methanol, toluene, lead and lead compounds which are known to the State of California to cause birth defects and other reproductive harm. For more information go to www.P65Warnings.ca.gov.

How to Order

8.1 How to Order O-Rings and Other Parts

8.1.1 Parker Compound Numbering System

From time to time, you will see Parker compound numbers shown in a three digit format without a zero (0) preceding the numerical designation. For example, compound N0674-70 may be shown as N674-70. The three digit format was previously used, but Parker has updated to the four digit format to allow utilization of a computer format for listing new compounds beyond 999. There is no difference in compounds shown with or without the zero (0) preceding the older three digit compound designations.

The information in these tables may be used as a guide in selecting the most suitable Parker O-ring compound to seal any common fluid, and in specifying the necessary size number for the desired dimensions.

For further assistance, please feel free to call your Parker Seal Territory Sales Manager or Parker O-ring Distributor. You may also contact the Inside Sales Department at the Parker Seal O-ring Division, 2360 Palumbo Drive, P.O. Box 11751, Lexington, Kentucky 40512; telephone number (859) 269-2351.

Parker compound numbers, with one notable exceptions, indicate the base polymer by a prefix letter, and the type A durometer hardness by a two digit suffix number. The basic number is merely a sequential number and has no particular significance. In some instances, the prefix letter is followed by a secondary letter. This indicates a specialty property. See the following examples:

Example 1:

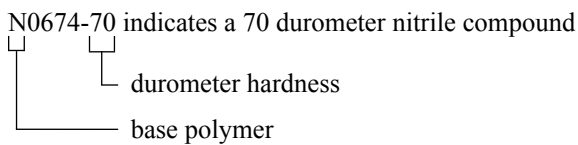

Example 2:

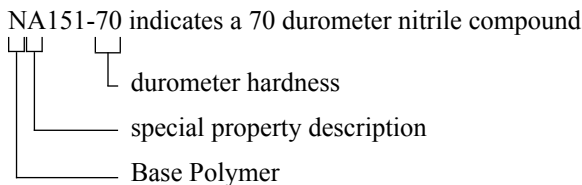

Prefix letters on compound designations used by Parker Seal, and the base polymers and specialty property description they indicate are identified in Table 8-1a and 8-1b.

Note that there is only one base polymer and one hardness associated with each basic number (i.e. there is not both N0674-70 and N0674-90).

Active Compound Designation Codes	
Letter	Polymer
A	Polyacrylate, Ethylene Acrylic
B	Butyl
C	Neoprene
E	Ethylene, Propylene
L	Fluorosilicone
N	Nitrile, Hydrogenated, Carboxylated
P	Polyurethane
S	Silicone
V	Fluorocarbon, Perfluorinated elastomer, AFLAS

Table 8-1a: Compound Designation Codes

Specialty Property	
Letter	Description
A	General purpose
B	Low compression set
E	Ethylene acrylate
F	Fuel resistant or fully fluorinated
G	Higher fluorine content
J	NSF / FDA / WRAS approvals
L	Internally lubed
M	Mil / AMS specifications
P	Low temperature flexible or tetrafluoroethylene - propylene
W	Non-black compound
X	Carboxylated

Table 8-1b: Compound Specialty Property

WARNING: These products can expose you to chemicals including carbon black (airborne and extracts), antimony trioxide, titanium dioxide, silica (crystalline), di(2-ethylhexyl) phthalate, ethylene thiourea, acrylonitrile, 1,3-butadiene, epichlorohydrin, toluenediisocyanate, tetrafluoroethylene, ethylbenzene, formaldehyde, furfuryl alcohol, glass fibers, methyl isobutyl ketone, nickel (metallic and compounds), lead and lead compounds which are known to the State of California to cause cancer; and 1,3-butadiene, epichlorohydrin, di(2-ethylhexyl)phthalate, di-isodecyl phthalate, ethylene thiourea, methyl isobutyl ketone, methanol, toluene, lead and lead compounds which are known to the State of California to cause birth defects and other reproductive harm. For more information go to www.P65Warnings.ca.gov.

Military Fluid Specification Description

Fluid Specification	Parker O-Ring Compound	Description	Fluid Specification	Parker O-Ring Compound	Description
MIL-L-2104	N0304-75	Oil, Engine	MIL-E-8500	E1267-80	Ethylene Glycol, Technical, Uninhibited
MIL-S-3136	N0602-70	Standard Test Fluids, Hydrocarbon	MIL-G-10924	N0304-75	Automotive Grease
MIL-L-3150	N0304-75	Oil, Preservative	MIL-H-13910	E1267-80	Hydraulic Fluid, Non-petroleum Automotive Brake
MIL-G-3278	LM159-70	Aircraft Grease	MIL-L-15017	N0304-75	Oil, Hydraulic
MIL-O-3503	N0304-75	Oil, Preservative	MIL-G-15793	N0304-75	Grease, Instrument
MIL-G-3545	N0304-75	Hi-Temperature Grease	MIL-F-16884	N0304-75	Fuel Oil, Diesel, Marine
MIL-G-4339	N0304-75	Soluble Oil	MIL-F-17111	N0304-75	Power Transmission Fluid
MIL-G-4343	N0304-75	Pneumatic System Grease	MIL-L-17331	V1164-75	Lubricating Oil, Non-corrosive, Steam Turbine
MIL-J-5161	N0602-70	Jet Fuel, Referee	MIL-H-19457	E1267-80	Fire Resistant Hydraulic Fluid (phosphate-ester base)
MIL-F-5566	E1267-80	Isopropyl Alcohol	MIL-L-21260	N0304-75	Lubricating Oil, Engine, Preservative
MIL-G-5572	N0602-70	Fuel, Aircraft Reciprocating Engine, Grades 80/87 91/96, 100/130,115/145 Aviation Gas	MIL-S-21568	E1267-80	Silicone Fluid, Dimethyl Polysiloxane
MIL-H-5606	(1)	Hydraulic Fluid, Petroleum Base, Aircraft and Ordnance	MIL-H-22251	E1267-80	Hydrazine Solution, 22%
MIL-T-5624	N0602-70	Jet Fuel JP-4, JP-5	MIL-L-23699	V1164-75	Lubricating Oil, Aircraft Turbine Engine, Synthetic Base
MIL-L-6081	N0304-75	Jet Engine Oil	MIL-G-23827	N0602-70	Grease, Aircraft and Instrument
MIL-L-6082	N0304-75	Lubricating Oil, Aircraft Reciprocating Piston Engine	MIL-G-25013	V1164-75	Bearing Grease, Extreme High Temperature
MIL-H-6083	N0304-75	Hydraulic Fluid, Preservative	MIL-G-25537	N0304-75	Aircraft, Helicopter Oscillating Bearing Grease
MIL-L-6085	V1164-75	Synthetic Di-ester Base Fluid	MIL-F-25558	N0602-70	Fuel, Ram Jet (RJ1)
MIL-A-6091	E1267-80	Denatured Ethyl Alcohol	MIL-C-25576	N0602-70	Rocket and Ram Jet Fuel (RP1)
MIL-L-6387	V1164-74	Synthetic Di-ester Base Lubricating Oil	MIL-F-25656	N0602-70	Jet Fuel, Grade JP6
MIL-C-7024	N0602-70	Aircraft Calibrating Fluid	MIL-L-25681	V1164-75	Oil, Moly Disulphide, Silicone Base, High Temperature
MIL-H-7083	E1267-70	Hydraulic Fluid, Hydrolube	MIL-G-25760	V1164-75	Bearing Grease, Wide Temp. Range
MIL-G-7118	N0304-75	Actuator Grease	MIL-P-27402		Propellant, Aerozine-50
MIL-G-7187	N0304-75	Grease, Graphite	MIL-H-27601	V1164-75	Hydraulic Fluid, Petroleum Base, High Temperature, Flight Vehicle
MLO-7277	V1164-75	Hydraulic Fluid, Petroleum Base, Hi-Temp.	MIL-L-46167	N0304-75	Lubricating Oil, Internal Combustion Engine, Arctic
MIL-G-7421	LM159-70	Grease, Extreme Low Temp.	MIL-H-46170	(2)	Hydraulic Fluid, Rust Inhibited, Fire Resistant, Synthetic
MLO-7557	V1164-75	Hydraulic Fluid, Petroleum Base, Hi-Temp.	MIL-F-81912	V1164-75	Fuel, Expendable, Turbine Engine
MIL-G-7711	N0304-75	Grease, General Purpose	MIL-F-82522	N0602-75	Fuel, Ramjet Engine, T-H Dimer Grade RJ-4
MIL-L-7808	V1164-75	Lubricating Oil, Aircraft Turbine Engine, Synthetic Di-ester Base	MIL-T-83133	47-071	Turbine Fuel, Aviation, Kerosene Type, Grade JP-8
MIL-L-7870	N0304-75	Lubricating Oil, Low Temperature, General Purpose	MIL-H-83282	(2)	Hydraulic Fluid, Fire Resistant, Synthetic Hydrocarbon Base, Aircraft
MIL-C-8188	V1164-75	Corrosion Preventive Oil, Syn. Base	MIL-H-87257	(2)	Hydraulic Fluid, Fire Resistant, Synthetic Hydrocarbon Base, Aircraft, Low Temperature
MLO-8200	V1164-75	Hydraulic Fluid, Aircraft and Missile, Silicate-ester Base			
MIL-H-8446	V1164-75	Hydraulic Fluid, Silicate-ester Base (MLO-8515)			
MLO-8515	V1164-75	Hydraulic Fluid, Silicate-ester Base (MIL-H-8446)			
MIL-L-9000	N0304-75	Lubricating Oil, Diesel			
MIL-L-9236	V1164-75	Synthetic Lubricating Oil, Turbine			

(1) -48°C to +113°C (-55°F to +235°F), cpd. N0304-75
-54°C to +135°C (-65°F to +275°F), cpd. N0756-75

(2) -26°C to +204°C (-15°F to +400°F), cpd. V1164-75
-29°C to +135°C (-20°F to +275°F), cpd. N0951-75
-54°C to +135°C (-65°F to +275°F), cpd. N0756-75

Recommended compounds are military quality, meeting military material specifications. Appropriate industrial compounds may be selected from the Fluid Compatibility Table in [Section VII](#).

Table 8-2: Military Fluid Specification Description

WARNING: These products can expose you to chemicals including carbon black (airborne and extracts), antimony trioxide, titanium dioxide, silica (crystalline), di(2-ethylhexyl) phthalate, ethylene thiourea, acrylonitrile, 1,3-butadiene, epichlorohydrin, toluenediisocyanate, tetrafluoroethylene, ethylbenzene, formaldehyde, furfuryl alcohol, glass fibers, methyl isobutyl ketone, nickel (metallic and compounds), lead and lead compounds which are known to the State of California to cause cancer; and 1,3-butadiene, epichlorohydrin, di(2-ethylhexyl)phthalate, di-isodecyl phthalate, ethylene thiourea, methyl isobutyl ketone, methanol, toluene, lead and lead compounds which are known to the State of California to cause birth defects and other reproductive harm. For more information go to www.P65Warnings.ca.gov.

Military Rubber Specifications

Note: In keeping with the Federal Acquisition Streamlining Act (FASA), most of these specifications are in the process of being revised to AMS specifications. For the most current information, contact the O-Ring Division.

Rubber Specification		Parker Compound	Temperature Range ⁽²⁾	Description
Class	Grade			
ZZ-R-765E				
1a. 1b. 2a. 2b.	40	S1198-40	- 103 to 437°F (-75 to 225°C)	Rubber, Silicone
1a. 1b. 2a. 2b.	50	S0899-50	- 103 to 437°F (-75 to 225°C)	Low and High Temperature Resistant, Low Compression Set
1a. 1b.	70	S0383-70	- 103 to 437°F (-75 to 225°C)	Low and High Temperature Resistant, Low Compression Set
2a. 2b.	80	S0614-80	- 80 to 437°F (-62 to 225°C)	Low Temperature Resistant, Low Compression Set
2a. 2b.	70	S1224-70	- 80 to 437°F (-62 to 225°C)	High Temperature Resistant, Low Compression Set
2b.	60	S0613-60	- 80 to 437°F (-62 to 225°C)	High Temperature Resistant, Low Compression Set
Note: A-A-59588 supercedes ZZR-R-765E				
MIL-G-1149C- Gasket Materials, Synthetic Rubber, 50 and 65 Durometer Hardness				
Type I		C0267-50	(-20 to 212°F) (-29 to 100°C) ⁽²⁾	
Class 1				
MIL-R-3533B - Rubber, Synthetic; Sheet, Strip and Molded				
Type I		N0602-70	(-20 to 158°F) (-29 to 70°C) ⁽²⁾	
Grade B				
MIL-P-5315B - Packing, O-ring, Hydrocarbon Fuel Resistant (Jet Fuels)				
		N0602-70	(-65 to 160°F) (-54 to 71°C)	(Military O-ring series MS29512 and MS29513)
Note: AMS-P-5315 supercedes MIL-P-53158				
MIL-P-5510C - Gasket, Straight Thread Tube Fitting Boss (MIL-H-5606 Petroleum Based Hydraulic Fluid,				
		N0507-90	(-45 to 160°F) (-43 to 71°C) ⁽²⁾	(Military O-ring series MS28778)
Note: AMS-P-5510 supercedes MIL-P-5510				
MIL-DTL-7362D - Rubber, Sheet, Molded and Extruded Shapes, Synthetic Oil Resistant (AMS3021)				
Types I, II		47-071	Synthetic, Di-Ester Base Lubricant (-65 to 275°F) (-54 to 135°C) ⁽²⁾	(Military O-ring series MS29561 and WAS617)
Note: AMS-R-7362 supercedes MIL-R-7362D				
MIL-G-21569B - Gaskets, Cylinder Liner Seal, Synthetic				
Class I		N0674-70 ⁽¹⁾		(Room temperature to 194°F) (RT to 90°C)
Class II		S0604-70		
MIL-DTL-25732C - Packing, Preformed, Petroleum Hydraulic Fluid Resistant (MIL-H-5606)				
		N0304-75		Petroleum Base Hydraulic Fluid (-65 to 275°F) (-54 to 135°C) ⁽²⁾ (Military O-ring series MS28775)
MIL-R-25988 - Rubber Fluorosilicone Elastomer, Oil and Fuel Resistant (MIL-H-5606 Petroleum Base)				
Type 1, Class 1, Grade 60/3		LM158-60		Hydraulic Fluid, Fuel, Air (-90 to 350°F)(-68 to 176°C) ⁽²⁾
Type 1, Class 1, Grade 70/1		LM159-70		
Type 1, Class 1, Grade 80/4		LM160-80		
Type 1, Class 3, Grade 75/2		L1077-75 ⁽¹⁾		
Note: AMS-R-25988 supercedes MIL-R-35988				
MIL-P-82744 - Packing, Preformed, Otto Fuel Compatible				
		E0515-80		(-65 to 250°F) (-54 to 121°C)
MIL-R-83248C, Type I - Rubber, Fluorocarbon Elastomer, High Temperature Fluid and Compression				
Class I		V0747-75, V1164-75, V1226-75		Set Resistant (-15 to 400°F) (-5 to 105°C)
Class 2		V0709-90		
Note: AMS-R-83248 supercedes MIL-R-83248C				
MIL-R-83485				
	Grade 80	VM835-75		Rubber, fluorocarbon Elastomer, Improved performance @ Low Temp (-40 to 400°C)
Note: AMS-R-83485 supercedes MIL-R-83485				
MIL-P-83461B - Packings, Preformed, Petroleum Hydraulic Fluid Resistant, Improved Performance				
		N0756-75		(-65 to 275°F) (-54 to 135°C) ⁽²⁾
Note: AMS-P-5315 supercedes MIL-P-53158				

Notes: When ordering parts made with a military, AMS or NAS specification material, see the section on ordering.

(1) Extra charges may apply for testing and documentation.

(2) These temperatures are limits for particular tests required by the specifications, but they do not necessarily represent operating temperature limits.

(3) Inactive for new design, refer to MIL-P-25732. See discussion on "Temperature" in the Basic O-Ring Elastomers Section (II).

Table 8-3: Military Rubber Specifications

WARNING: These products can expose you to chemicals including carbon black (airborne and extracts), antimony trioxide, titanium dioxide, silica (crystalline), di(2-ethylhexyl) phthalate, ethylene thiourea, acrylonitrile, 1,3-butadiene, epichlorohydrin, toluenediisocyanate, tetrafluoroethylene, ethylbenzene, formaldehyde, furfuryl alcohol, glass fibers, methyl isobutyl ketone, nickel (metallic and compounds), lead and lead compounds which are known to the State of California to cause cancer; and 1,3-butadiene, epichlorohydrin, di(2-ethylhexyl)phthalate, di-isodecyl phthalate, ethylene thiourea, methyl isobutyl ketone, methanol, toluene, lead and lead compounds which are known to the State of California to cause birth defects and other reproductive harm. For more information go to www.P65Warnings.ca.gov.

AMS⁽¹⁾ and NAS⁽²⁾ Rubber Specification Descriptions

Rubber Specification	Parker Compound	Description	
		Durometer	Title
AMS3201	N0545-40	35-45	Dry Heat Resistance
AMS3205	N0299-50	45-55	Low Temperature Resistance
AMS3208	C0267-50	45-55	Weather Resistant, Chloroprene Type
AMS3209	C1124-70	65-75	Weather Resistant, Chloroprene Type
AMS3212	N0525-60	55-65	Aromatic Fuel Resistant
AMS 3238	B0318-70	65-75	Phosphate-Ester Resistant, Butyl Type
AMS3301	S0469-40	35-45	Silicone, General Purpose
AMS3302	S0595-50	45-55	Silicone, General Purpose
AMS3303	S0613-60	55-65	Silicone, General Purpose
AMS3304	S1224-70	65-75	Silicone, General Purpose
AMS3305	S0614-80	75-85	Silicone, General Purpose
AMS3325	LM158-60	55-65	Fluorosilicone Rubber, Fuel and Oil Resistant
AMS3337	S0383-70	65-75	Silicone, Extreme Low Temperature Resistant
AMS3345	S0899-50	45-55	Silicone Rubber
AMS3357	S1224-70	65-75	Silicone Rubber, Lubricating Oil, Compression Set Resistant
AMS7257	FF200-75	70-80	Sealing Rings, Perfluorocarbon, High Temperature Resistant
AMS7259	V0709-90	85-95	High Temp, Fluid Resistant, Very Low Compression Set FKM
AMS7267	S0355-75	70-80	Silicone, Heat Resistant, Low Compression Set
AMS7271	N0506-65	60-70	Fuel and Low Temperature Resistant
AMS7272	N0287-70	65-75	Synthetic Lubricant Resistant
AMS7276	V1164-75	70-80	High Temp. Fluid Resistant, Very Low Compression Set FKM
NAS1613 Rev 2	E0515	80-75	Packing, O-ring, Phosphate Ester Resistant
NAS1613 Rev 5	E1267-80	75-85	Packing, O-ring, Phosphate Ester Resistant
AMS-P-5315	N0602-70	65-75	Packing O-ring, Hydrocarbon Fuel Resistant
AMS-P-5510	N0507-90	85-95	Gasket, Straight Thread Tube Fitting Boss
AMS-R-7362	47-071	65-75	Rubber, Sheet, Molded and Extruded Shapes, Synthetic Oil Resistant
AMS-P-25732	N0304-75	70-80	Packing, Preformed, Petroleum Hydraulic Fluid Resistant, Limited Performance
AMS-R-25988	LM158-60, LM159-70, LM160-80, L1077-75	55-85	Rubber, Fluorosilicone Elastomer, Oil and Fuel Resistant
AMS-R-83248	V1164-75, V1226-75, V0709-90	70-95	Rubber, Fluorocarbon Elastomer, High Temperature Fluid and Compression Set Resistant
AMS-P-83461	N0756-75	70-80	Packings, Preformed, Petroleum Hydraulic Fluid Resistant, Improved Performance
AMS-R-83485	VM835-75	70-80	Rubber, Fluorocarbon Elastomer, Improved Performance at Low Temperatures

Note: When ordering parts made with military, AMS, or NAS specification material, see section on ordering.

(1) Aerospace Material Specification issued by the Society of Automotive Engineers, Inc.

(2) National Aerospace Standard issued by Aerospace Industries Association of America, Inc.

Table 8-4: AMS⁽¹⁾ and NAS⁽²⁾ Rubber Specification Descriptions

WARNING: These products can expose you to chemicals including carbon black (airborne and extracts), antimony trioxide, titanium dioxide, silica (crystalline), di(2-ethylhexyl) phthalate, ethylene thiourea, acrylonitrile, 1,3-butadiene, epichlorohydrin, toluenediisocyanate, tetrafluoroethylene, ethylbenzene, formaldehyde, furfuryl alcohol, glass fibers, methyl isobutyl ketone, nickel (metallic and compounds), lead and lead compounds which are known to the State of California to cause cancer; and 1,3-butadiene, epichlorohydrin, di(2-ethylhexyl)phthalate, di-isodecyl phthalate, ethylene thiourea, methyl isobutyl ketone, methanol, toluene, lead and lead compounds which are known to the State of California to cause birth defects and other reproductive harm. For more information go to www.P65Warnings.ca.gov.

Compound Selections for Commonly Used SAE and ASTM Specifications

This table is in accordance with the 1997 revision of ASTM D2000, which requires that minimum tensile strength indications shall be expressed in SI units (Megapascals). The “M” prefix in these callouts signifies this fact, and the requirement is shown in the 6th and 7th characters of each specification (excluding the “ASTM D2000”). For example,

in the specification number M2BC614, the “14” indicates that the tensile strength of the material shall not fall below 14 MPa. To convert this value to psi (pounds per square inch), multiply by 145. In this example, the equivalent is 104.1 Bar (2030 psi) .

Compound Selections For Commonly Used SAE and ASTM Specifications

ASTM D200-97 Specification	MIL-R-3065 ASTM D735-58/ SAE J14 Specification	Parker Compound Number
M2AA708 A13 EA14 F17		E0603-70
M2AA810 A13 EA14 F17 Z1 (Purple)		E0893-80
M2AA810 A13 EA14 F17	R810BF ₂	E0515-80
M2AA810 A13 EA14 F17	R810BF ₂	E0540-80
M2AA907 A13 EA14 F17		E0652-90
M3BA707 A14		B0612-70
M2BC510 A14 B14 EO14 EO34 F17	SC515BE ₁ E ₃ F ₂	C0267-50
M3BC614 A14 B14 EO14 EO34 F17	SC615BE ₁ E ₃ F ₁	C0518-60
M3BC710 A14 B14 EO14 EO34	SC715BE ₃ F ₁	C0873-70
M3BC710 A14 B14 EO14 EO34 F17	SC715BE ₃ F ₂	C1124-70
M2BE510 A14 B14 EO14 EO34 F17		C0267-50
M2BE614 A14 B14 EO14 EO34 F17		C0518-60
M3BE710 A14 B14 EO14 EO34		C0873-70
M2BE710 A14 B14 EO14 EO34 F17		C0147-70
M2BF714 B34 EO14 EO34		N0674-70
M2BG410 B34 EA14 EF11 EF21 EO14 EO34	SB415BE ₁ E ₃ F ₁	N0545-40
M5BG410 A14 B34 EO14 EO34		N0545-40
M2BG510 B14 EA14 EF11 EF21 EO14 EO34 F17	SB515A ₁ BE ₁ E ₃ F ₂	N0299-50
M2BG510 A14 B14		N0299-50
M2BG608 B34 EA14 EO14 F17 Z1 (65 ± 5 Type A Durometer)	SB712BE ₁ F ₂	N0506-65
M2BG614 B34 EA14 EF11 EF21 EO14 EO34 F17	SB620BE ₁ F ₁	N0525-60
M2BG708 EA14 EF11 EF21 EO14 EO34 F17		N0602-70
M2BG708 EF11 EF21 EO34 F17		47-071
M5BG710 A14 B14		N0497-70
M2BG710 B14 B34 EA14 EF11 EF21		N0497-70
M2BG714 B14 B34 EA14 EF11 EF21 EO14 EO34	SB715A ₁ BE ₁ E ₃	N0674-70
M(5)BG714 A14 B14 B34 EO14 EO34		N0103-70
M2BG714 B14 B34 EA14 EF11 EF21 EO14 EO34 F17	SB715BE ₁ E ₃ F ₂	N0103-70
M4BG721 B14 EO14 EO34		P0642-70
M7BG810 EA14 EF11 EF21 EO14 EO34 Z1 (75 ± 5 Type A Durometer) Z2 (1)		N0951-75
M7BG810 EA14 EF11 EO14 EO34 F16 Z1 (75 ± 5 Type A Durometer)	SB708E ₁ E ₃ F ₂	N0304-75
M7BG910 B14 EA14 EF11 EF21 EO14 EO34 F16	SB915BE ₁ E ₃	N0507-90
M2BG910 B14 EA14 EF21 EO14 EO34	SB915BE ₁ E ₃	N0552-90
M(2)CA614 A25 B44		E0529-60
M3CA710 A25 B44 EA14		E1244-70
M4CA714 A25 B35 EA14 F17 G21		E0803-70
M8CA814 A25 B35 EA14 F17		E0810-80

Prefix (grade) numbers and suffix letters in parenthesis are technically “not permitted”, but nevertheless, they describe a property of the material. Explanations in parenthesis apply to the Z suffix letters.

(1) Compression Set = 20% max. after 70 hours at 125°C when tested on plied discs per ASTM D395.

Table 8-5: Compound Selections for Commonly Used SAE and ASTM Specifications



WARNING: These products can expose you to chemicals including carbon black (airborne and extracts), antimony trioxide, titanium dioxide, silica (crystalline), di(2-ethylhexyl) phthalate, ethylene thiourea, acrylonitrile, 1,3-butadiene, epichlorohydrin, toluenediisocyanate, tetrafluoroethylene, ethylbenzene, formaldehyde, furfuryl alcohol, glass fibers, methyl isobutyl ketone, nickel (metallic and compounds), lead and lead compounds which are known to the State of California to cause cancer; and 1,3-butadiene, epichlorohydrin, di(2-ethylhexyl)phthalate, di-isodecyl phthalate, ethylene thiourea, methyl isobutyl ketone, methanol, toluene, lead and lead compounds which are known to the State of California to cause birth defects and other reproductive harm. For more information go to www.P65Warnings.ca.gov.

Compound Selections for Commonly Used SAE and ASTM Specifications (Continued)

ASTM D200-97 Specification	MIL-R-3065 ASTM D735-58/ SAE J14 Specification	Parker Compound Number
M2CH608 A25 B34 F17 Z1 (65 ± 5 Type A Durometer)		N0506-65
M3CH708 A25 B14 B34 EO16 EO36 EF31		N0497-70
M2CH708 A25 EO35 F17		47-071
M3CH714 A25 B14 EO16 EO36		N0674-70
M3CH714 A25 B34 EO16 EO36		N0674-70
M3CH810 A25 EO16 Z1 (75 ± 5 Type A Durometer) Z2 (1)		N0951-75
M3CH810 A25 EO16 Z1 (75 ± 5 Type A Durometer)		N0304-75
M3CH910 B34 EO16 EO36		N0552-90
M2CH910 EO15 EO35 Z1 (80% Min Elongation)		N1210-90
M3DA710 A26 B36 EA14 Z1 (75+/-5 type A Durometer) Z2 (130% Min Elongation)		EO692-75
M3DA810 A26 B36 EA14		E0540-80
M2DH710 A26 B16 EO16 EO36Z1 (175% Min Elongation)		N1173-70
M2DH810 A26 B16 EO16		N1231-80
M3DH710 A26 B16 EO16 EO36 F13	TB715E ₁ E ₃	AA150-70
M2DH910 A26 B36 EO16 EO36		KB163-90
M2FK606 A19 EA36		LM158-60
M2FK606 A19 EF31 Z1 (70+/-5 type A Durometer)		LM159-70
M2GE405 A19 B37 EA14 EO16 EO36 F19 G11		S0469-40
M3GE503 A19 B37 EA14 EO16 EO36 F19 G11	TA507BE ₁ E ₃ F ₂	S0595-50
M3GE603 A19 B37 EA14 EO16 EO36 F19 G11	TA605BE ₁ E ₃ F ₂	S0613-60
M3GE603 A19 EO16 F19		S0317-60
M7GE705 A19 B37 EA14 EO16 EO36 F19 G11	TA705BE ₁ E ₃ F ₂	S0455-70
M7GE705 A19 B37 EA14 EO16 EO36 F19 G11	TA705BE ₁ E ₃ F ₂	S1224-70
M7GE705 F19		S0383-70
M6GE803 A19 B37 EA14 EO16 EO36 F19 G11	TA805BE ₁ E ₃ F ₂	S0614-80
M2HK710 A1 - 10 B37 B38 EF31 EO78 Z1 (75 ± 5 Type A Durometer)		V1164-75
M2HK710 A1 - 10 B37 B38 EF31 EO78 Z1 (75 ± 5 Type A Durometer) Z2 (Brown)		V1226-75
M4HK710 A1 - 11 B38 EF31 EO78 Z1 (75 ± 5 Type A Durometer)		V1164-75
M4HK710 A1 - 11 B38 EF31 EO78 Z1 (75 ± 5 Type A Durometer) Z2 (Brown) Z3 (150% Min Elongation)		V1226-75
M6HK810 A1-10 B38 EF31 EO78 EO88 Z1 (75 ± 5 Type A Durometer)		V0747-75
M7HK810 A1-11 B38 Z1 (75 ± 5 Type A Durometer) Z2 (130% Min Elongation)		VM835-75
M3HK910 A1 - 10 B37 EF31 EO78		V0709-90
M3HK910 A1 - 10 B37 B38 EF31 EO78 Z1 (Brown)		V0894-90
M5HK910 A1 - 11 B38 EF31 EO78		V0709-90
M5HK910 A1 - 11 B38 EF31 EO78 Z1 (Brown)		V0894-90
M2HK910 B37 C12 EF31 Z1 (95 ± 5 Type A Durometer) Z2 (80% Min Elongation)		V1238-95
SAE 120RI Class 1		NA151-70
SAE 120R1 Class 2		N0497-70
SAE J515 Type 1		N0552-90
SAE J515 Type 2		E0652-90

Prefix (grade) numbers and suffix letters in parenthesis are technically “not permitted,” but nevertheless, they describe a property of the material. Explanations in parenthesis apply to the Z suffix letters.

(1) Compression Set = 20% max. after 70 hours at 125°C when tested on plied discs per ASTM D395.

Table 8-5: Compound Selectons for Commonly Used SAE and ASTM Specifications

Revisions from Older Versions of ASTM

Old		New
E14	=	E014
E34	=	E034
L14	=	EA14
E51	=	EF11
E61	=	EF21
E71	=	EF31



WARNING: These products can expose you to chemicals including carbon black (airborne and extracts), antimony trioxide, titanium dioxide, silica (crystalline), di(2-ethylhexyl) phthalate, ethylene thiourea, acrylonitrile, 1,3-butadiene, epichlorohydrin, toluenediisocyanate, tetrafluoroethylene, ethylbenzene, formaldehyde, furfuryl alcohol, glass fibers, methyl isobutyl ketone, nickel (metallic and compounds), lead and lead compounds which are known to the State of California to cause cancer; and 1,3-butadiene, epichlorohydrin, di(2-ethylhexyl)phthalate, di-isodecyl phthalate, ethylene thiourea, methyl isobutyl ketone, methanol, toluene, lead and lead compounds which are known to the State of California to cause birth defects and other reproductive harm. For more information go to www.P65Warnings.ca.gov.

8.2 International O-Ring Standards and Test Methods

Germany	
DIN 3770	Sealing rings (O-rings) with special accuracy made of elastomeric materials. This standard should not be used for new designs.
DIN 3771 Part 1	Fluid systems, O-rings, sizes to ISO 3601-1. This standard contains sizes and tolerances of O-rings with special accuracy for general applications in fluid systems.
DIN 3771 Part 2	Fluid systems, O-rings, testing, marking. This standard applies to DIN 3771 Part 1, testing and marking of O-rings.
DIN 3771 Part 3	Fluid systems, O-rings, field of application, materials. This standard covers materials, their hardness range and fields of application of O-rings to DIN 3771 Part 1.
DIN 3771 Part 4	Fluid systems, O-rings, quality acceptance criteria, surface finish and form. This standard covers acceptance criteria for surface finish and form.
DIN 7715	Rubber parts; tolerances, molded shapes from soft rubber (elastomers).
DIN 7716	Products from rubber; requirements for storage, cleaning and servicing.
DIN 9088	Aerospace; shelf-life of parts from elastomers (under preparation).
DIN 24 320	Fire resistant hydraulic fluids, group HFA-1, properties and requirements.
DIN 40 080	Procedures and tables for inspection by attributes – statistical sampling.
DIN 50 049	Certification of material testing.
DIN 51 524	Hydraulic fluids, hydraulic oils H and H-L; minimum requirements.
DIN 51 525	Hydraulic fluids; hydraulic oils H-LP; minimum requirements.
DIN 51 600	Liquid fuels, leaded petroleum oils; minimum requirements.
DIN 51 601	Liquid fuels, Diesel oil; minimum requirements.
DIN 51 603 Part 1	Liquid fuels; heating oils, heating oil EL; minimum requirements.
DIN 51 603 Part 2	Liquid fuels; heating oils, heating oils L, M and S; minimum requirements.
DIN 53 479	Testing of plastics and elastomers; measurement of specific gravity.
DIN 53 504	Testing of elastomers; measurement of tensile strength, maximum stress, elongation at break and stress values at tensile test.
DIN 53 505	Testing of elastomers; Shore A and D hardness tests.
DIN 53 507	Testing of elastomers; determination of tear growth, strip specimen.
DIN 53 512	Testing of rubbers; determination of rebound resilience.
DIN 53 516	Testing of rubbers and elastomers; determination of abrasion resistance.
DIN 53 517	Testing of elastomers - determination of compression set.
DIN 53 519 Part 1	Testing of elastomers; determination of indentation hardness of soft rubber (IRHD), hardness test on samples.
DIN 53 519 Part 2	Testing of elastomers; determination of indentation hardness of soft rubber (IRHD), microhardness on samples of minor dimensions.
DIN 53 521	Testing of rubber and elastomers; determination of the resistance to liquids, vapors and gases.
DIN 53 522	Testing of elastomers; determination of resistance to flex-cracking and crack growth.
DIN 53 538	Standard reference elastomer; nitrile-butadiene rubber (NBR), cross-linked by peroxide to characterize working fluids with respect to their reaction on NBR.
DIN 53 545	Testing of rubber; determination of the behavior at low temperature (behaviour to cold), principles, testing methods.
DIN 53 670	Testing of rubber or elastomers; testing of rubber in standard text mixtures, equipment and procedures.
DIN ISO 1629	Rubber and latex; difference and abbreviations.
VDMA 24 317	Fluid systems; hydraulic, fire-resistant hydraulic fluids, guidelines.
LN 9214	Aerospace; toroidal sealing rings (O-rings) for solderless tube fittings with coupling sleeves, flareless.

International	
ISO 3601/1	Fluid systems, O-rings - Part 1. Inner diameters, cross-sections, tolerances and size coding.
ISO 3601/2 (under preparation)	Fluid systems, O-rings - Part 2. Design criteria for O-ring grooves.
ISO 3601/3 (under preparation)	Fluid systems, O-rings - Part 3. Quality acceptance levels.
ISO 3601/4 (under preparation)	Fluid systems, O-rings - Part 4. O-ring grooves with back-up rings.
ISO 3601/5 (under preparation)	Fluid systems, O-rings - Part 5. O-rings for connectors to ISO 6149.
United Kingdom	
BS 1806	Specifies dimensions (inches) for inner diameters and cross-sections and their tolerances including grooves. O-ring dimensions are identical with the Parker 2-xxx series. Table 11.1 gives a cross-reference among the various European standard specifications.
BS 4518	Specifies dimensions and tolerances together with groove dimensions. Cross-section diameters are: 1.6 / 2.4 / 3.0 / 5.7 and 8.4 mm
France The following French standards base upon ISO 3601 Parts 1 to 3:	
NF-T-47-501	is comparable with ISO 3601 Part 1.
NF-T-47-502	is comparable with ISO 3601 Part 2.
NF-T-47-503	is comparable with ISO 3601 Part 3.
French purchase codes R 1 to R 27 are identical with Parker sizes 5-578 to 5-606. R 28 to R 88 are identical with Parker sizes 2-325 to 2-349 and 2-425 to 2-460. For more details, cf European O-ring codes, Table 11.1.	
Italy	
A committee for seal and hose standardization exists in the UNI which recommends the use of the American AS 568 A standard specification. In certain areas the French R 1 to R 88 are used.	
Sweden	
O-rings are standardized under SMS 1586, Swedish military standard. Cross sections 1.6 / 2.4 / 3.0 / 5.7 and 8.4 mm are recommended.	
United States	
AS 568 B (Aerospace Standard)	Published by the SAE (Society of Automotive Engineers) specifies sizes and tolerances. The cross-section tolerances correspond to ISO 3601/1 and DIN 3771 Part 1 (within a few hundredths of a millimeter), see Table 11.1, Cross Reference List.

8.3 Ordering Addresses

DIN and DIN ISO standard specifications and VDMA recommendations can be obtained from:

Beuth Verlag GmbH
Burggrafenstrasse 4-10, D-10787
Berlin

AMS and SAE specifications can be obtained from:

SAE
400 Commonwealth Dr.
Warrendale, PA 15096-0001

ASTM standard specifications can be obtained from:

ASTM
100 Barr Harbor Drive.
West Conshohocken, PA 19428

Military specifications can be obtained from:

Defense Automated Printing Service
700 Robbins Ave., Building 4/D
Philadelphia, PA 19111-5094
ATTN: DODSSP



WARNING: These products can expose you to chemicals including carbon black (airborne and extracts), antimony trioxide, titanium dioxide, silica (crystalline), di(2-ethylhexyl) phthalate, ethylene thiourea, acrylonitrile, 1,3-butadiene, epichlorohydrin, toluenediisocyanate, tetrafluoroethylene, ethylbenzene, formaldehyde, furfuryl alcohol, glass fibers, methyl isobutyl ketone, nickel (metallic and compounds), lead and lead compounds which are known to the State of California to cause cancer; and 1,3-butadiene, epichlorohydrin, di(2-ethylhexyl)phthalate, di-isodecyl phthalate, ethylene thiourea, methyl isobutyl ketone, methanol, toluene, lead and lead compounds which are known to the State of California to cause birth defects and other reproductive harm. For more information go to www.P65Warnings.ca.gov.

Section IX Sizes

Parker Series 2-XXX O-Ring Sizes	9-2
Parker Series 3-XXX O-Ring Sizes	9-11
Parker Series 5-XXX O-Ring Sizes	9-12
Series 5- XXX Locator Table	9-17
ISO 3601-1, Series A Sizes	9-19
ISO 3601-1, Series G Sizes	9-20
JIS B2401 Sizes	9-21
Unusual Size Cross Reference to European O-Ring Codes and Sizes	9-23
ISO 6149 O-rings for Metric Tube Fittings	9-25

 **WARNING:** These products can expose you to chemicals including carbon black (airborne and extracts), antimony trioxide, titanium dioxide, silica (crystalline), di(2-ethylhexyl) phthalate, ethylene thiourea, acrylonitrile, 1,3-butadiene, epichlorohydrin, toluenediisocyanate, tetrafluoroethylene, ethylbenzene, formaldehyde, furfuryl alcohol, glass fibers, methyl isobutyl ketone, nickel (metallic and compounds), lead and lead compounds which are known to the State of California to cause cancer; and 1,3-butadiene, epichlorohydrin, di(2-ethylhexyl)phthalate, di-isodecyl phthalate, ethylene thiourea, methyl isobutyl ketone, methanol, toluene, lead and lead compounds which are known to the State of California to cause birth defects and other reproductive harm. For more information go to www.P65Warnings.ca.gov.

Sizes

Parker Series 2-XXX O-Ring Sizes

1 Parker Size No. (Size Only) (a)	2 Size Only AS 568A Uniform Dash No.	3 Nominal Size (Inches) (Ref. Only)			4 Standard O-Ring Size (Units are in Inches) Actual (b) Per AS 568A				5 (Ref. Only) Basic Volume Cu. In.	6 Metric O-Ring Size (Units are in Millimeters) Actual (b) Per AS 568A				7 Parker Size No. (Size Only) (a)
		I.D.	O.D.	W.	I.D.	Tolerance ±	W	±		I.D.	Tolerance ±	W	±	
2-001	-001	1/32	3/32	1/32	.029	.004	.040	.003	.0003	0,74	0,10	1,02	0,08	2-001
2-002	-002	3/64	9/64	3/64	.042	.004	.050	.003	.0006	1,07	0,10	1,27	0,08	2-002
2-003	-003	1/16	3/16	1/16	.056	.004	.060	.003	.0010	1,42	0,10	1,52	0,08	2-003
2-004	-004	5/64	13/64	1/16	.070	.005	.070	.003	.0017	1,78	0,13	1,78	0,08	2-004
2-005	-005	3/32	7/32	1/16	.101	.005	.070	.003	.0021	2,57	0,13	1,78	0,08	2-005
2-006	-006	1/8	1/4	1/16	.114	.005	.070	.003	.0022	2,90	0,13	1,78	0,08	2-006
2-007	-007	5/32	9/32	1/16	.145	.005	.070	.003	.0026	3,68	0,13	1,78	0,08	2-007
2-008	-008	3/16	5/16	1/16	.176	.005	.070	.003	.0030	4,47	0,13	1,78	0,08	2-008
2-009	-009	7/32	11/32	1/16	.208	.005	.070	.003	.0034	5,28	0,13	1,78	0,08	2-009
2-010	-010	1/4	3/8	1/16	.239	.005	.070	.003	.0037	6,07	0,13	1,78	0,08	2-010
2-011	-011	5/16	7/16	1/16	.301	.005	.070	.003	.0045	7,65	0,13	1,78	0,08	2-011
2-012	-012	3/8	1/2	1/16	.364	.005	.070	.003	.0052	9,25	0,13	1,78	0,08	2-012
2-013	-013	7/16	9/16	1/16	.426	.005	.070	.003	.0060	10,82	0,13	1,78	0,08	2-013
2-014	-014	1/2	5/8	1/16	.489	.005	.070	.003	.0068	12,42	0,13	1,78	0,08	2-014
2-015	-015	9/16	11/16	1/16	.551	.007	.070	.003	.0075	14,00	0,18	1,78	0,08	2-015
2-016	-016	5/8	3/4	1/16	.614	.009	.070	.003	.0083	15,60	0,23	1,78	0,08	2-016
2-017	-017	11/16	13/16	1/16	.676	.009	.070	.003	.0090	17,17	0,23	1,78	0,08	2-017
2-018	-018	3/4	7/8	1/16	.739	.009	.070	.003	.0098	18,77	0,23	1,78	0,08	2-018
2-019	-019	13/16	15/16	1/16	.801	.009	.070	.003	.0105	20,35	0,23	1,78	0,08	2-019
2-020	-020	7/8	1	1/16	.864	.009	.070	.003	.0113	21,95	0,23	1,78	0,08	2-020
2-021	-021	15/16	1-1/16	1/16	.926	.009	.070	.003	.0120	23,52	0,23	1,78	0,08	2-021
2-022	-022	1	1/8	1/16	.989	.010	.070	.003	.0128	25,12	0,25	1,78	0,08	2-022
2-023	-023	1-1/16	1-3/16	1/16	1.051	.010	.070	.003	.0136	26,70	0,25	1,78	0,08	2-023
2-024	-024	1-1/8	1-1/4	1/16	1.114	.010	.070	.003	.0143	28,30	0,25	1,78	0,08	2-024
2-025	-025	1-3/16	1-5/16	1/16	1.176	.011	.070	.003	.0151	29,87	0,28	1,78	0,08	2-025
2-026	-026	1-1/4	1-3/8	1/16	1.239	.011	.070	.003	.0158	31,47	0,28	1,78	0,08	2-026
2-027	-027	1-5/16	1-7/16	1/16	1.301	.011	.070	.003	.0166	33,05	0,28	1,78	0,08	2-027
2-028	-028	1-3/8	1-1/2	1/16	1.364	.013	.070	.003	.0173	34,65	0,33	1,78	0,08	2-028
2-029	-029	1-1/2	1-5/8	1/16	1.489	.013	.070	.003	.0188	37,82	0,33	1,78	0,08	2-029
2-030	-030	1-5/8	1-3/4	1/16	1.614	.013	.070	.003	.0204	41,00	0,33	1,78	0,08	2-030
2-031	-031	1-3/4	1-7/8	1/16	1.739	.015	.070	.003	.0219	44,17	0,38	1,78	0,08	2-031
2-032	-032	1-7/8	2	1/16	1.864	.015	.070	.003	.0234	47,35	0,38	1,78	0,08	2-032
2-033	-033	2	2-1/8	1/16	1.989	.018	.070	.003	.0249	50,52	0,46	1,78	0,08	2-033
2-034	-034	2-1/8	2-1/4	1/16	2.114	.018	.070	.003	.0264	53,70	0,46	1,78	0,08	2-034
2-035	-035	2-1/4	2-3/8	1/16	2.239	.018	.070	.003	.0279	56,87	0,46	1,78	0,08	2-035
2-036	-036	2-3/8	2-1/2	1/16	2.364	.018	.070	.003	.0294	60,05	0,46	1,78	0,08	2-036
2-037	-037	2-1/2	2-5/8	1/16	2.489	.018	.070	.003	.0309	63,22	0,46	1,78	0,08	2-037
2-038	-038	2-5/8	2-3/4	1/16	2.614	.020	.070	.003	.0324	66,40	0,51	1,78	0,08	2-038
2-039	-039	2-3/4	2-7/8	1/16	2.739	.020	.070	.003	.0340	69,57	0,51	1,78	0,08	2-039
2-040	-040	2-7/8	3	1/16	2.864	.020	.070	.003	.0355	72,75	0,51	1,78	0,08	2-040

- (a) The rubber compound must be added when ordering by the 2-size number (i.e., N0674-70 2-007). .040 Area = .001256
 (b) This chart provides dimensions for standard (AN) shrinkage materials ONLY. These correspond to AS568A dimensions. .050 Area = .001964
 O-rings manufactured out of compounds with different shrinkage rates (other than AN) will produce slightly different .060 Area = .002827
 dimensions and tolerances. For more information on shrinkage rates, see the Appendix. .070 Area = .003848
 (c) When ordering O-rings to a Military, AMS or NAS material Specification, see Section VIII, Specifications, for (sq. in.)
 more information.

Table 9-1: Parker Series 2-XXX O-Ring Sizes

WARNING: These products can expose you to chemicals including carbon black (airborne and extracts), antimony trioxide, titanium dioxide, silica (crystalline), di(2-ethylhexyl) phthalate, ethylene thiourea, acrylonitrile, 1,3-butadiene, epichlorohydrin, toluenediisocyanate, tetrafluoroethylene, ethylbenzene, formaldehyde, furfuryl alcohol, glass fibers, methyl isobutyl ketone, nickel (metallic and compounds), lead and lead compounds which are known to the State of California to cause cancer; and 1,3-butadiene, epichlorohydrin, di(2-ethylhexyl)phthalate, di-isodecyl phthalate, ethylene thiourea, methyl isobutyl ketone, methanol, toluene, lead and lead compounds which are known to the State of California to cause birth defects and other reproductive harm. For more information go to www.P65Warnings.ca.gov.

Parker Series 2-XXX O-Ring Sizes (Continued)

1 Parker Size No. (Size Only) (a)	2 Size Only AS 568A Uniform Dash No.	3 Nominal Size (Inches) (Ref. Only)			4 Standard O-Ring Size (Units are in Inches) Actual (b) Per AS 568A				5 (Ref. Only) Basic Volume Cu. In.	6 Metric O-Ring Size (Units are in Millimeters) Actual (b) Per AS 568A				7 Parker Size No. (Size Only) (a)
		I.D.	O.D.	W.	I.D.	Tolerance ±	W	±		I.D.	Tolerance ±	W	±	
2-041	-041	3	3-1/8	1/16	2.989	.024	.070	.003	.0370	75,92	0,61	1,78	0,08	2-041
2-042	-042	3-1/4	3-3/8	1/16	3.239	.024	.070	.003	.0400	82,27	0,61	1,78	0,08	2-042
2-043	-043	3-1/2	3-5/8	1/16	3.489	.024	.070	.003	.0430	88,62	0,61	1,78	0,08	2-043
2-044	-044	3-3/4	3-7/8	1/16	3.739	.027	.070	.003	.0460	94,97	0,69	1,78	0,08	2-044
2-045	-045	4	4-1/8	1/16	3.989	.027	.070	.003	.0491	101,32	0,69	1,78	0,08	2-045
2-046	-046	4-1/4	4-3/8	1/16	4.239	.030	.070	.003	.0521	107,67	0,76	1,78	0,08	2-046
2-047	-047	4-1/2	4-5/8	1/16	4.489	.030	.070	.003	.0551	114,02	0,76	1,78	0,08	2-047
2-048	-048	4-3/4	4-7/8	1/16	4.739	.030	.070	.003	.0581	120,37	0,76	1,78	0,08	2-048
2-049	-049	5	5-1/8	1/16	4.989	.037	.070	.003	.0612	126,72	0,94	1,78	0,08	2-049
2-050	-050	5-1/4	5-3/8	1/16	5.239	.037	.070	.003	.0642	133,07	0,94	1,78	0,08	2-050
2-102	-102	1/16	1/4	3/32	.049	.005	.103	.003	.0040	1,24	0,13	2,62	0,08	2-102
2-103	-103	3/32	9/32	3/32	.081	.005	.103	.003	.0048	2,06	0,13	2,62	0,08	2-103
2-104	-104	1/8	5/16	3/32	.112	.005	.103	.003	.0056	2,84	0,13	2,62	0,08	2-104
2-105	-105	5/32	11/32	3/32	.143	.005	.103	.003	.0064	3,63	0,13	2,62	0,08	2-105
2-106	-106	3/16	3/8	3/32	.174	.005	.103	.003	.0072	4,42	0,13	2,62	0,08	2-106
2-107	-107	7/32	13/32	3/32	.206	.005	.103	.003	.0081	5,23	0,13	2,62	0,08	2-107
2-108	-108	1/4	7/16	3/32	.237	.005	.103	.003	.0089	6,02	0,13	2,62	0,08	2-108
2-109	-109	5/16	1/2	3/32	.299	.005	.103	.003	.0105	7,59	0,13	2,62	0,08	2-109
2-110	-110	3/8	9/16	3/32	.362	.005	.103	.003	.0122	9,19	0,13	2,62	0,08	2-110
2-111	-111	7/16	5/8	3/32	.424	.005	.103	.003	.0138	10,77	0,13	2,62	0,08	2-111
2-112	-112	1/2	11/16	3/32	.487	.005	.103	.003	.0154	12,37	0,13	2,62	0,08	2-112
2-113	-113	9/16	3/4	3/32	.549	.007	.103	.003	.0171	13,94	0,18	2,62	0,08	2-113
2-114	-114	5/8	13/16	3/32	.612	.009	.103	.003	.0187	15,54	0,23	2,62	0,08	2-114
2-115	-115	11/16	7/8	3/32	.674	.009	.103	.003	.0203	17,12	0,23	2,62	0,08	2-115
2-116	-116	3/4	15/16	3/32	.737	.009	.103	.003	.0220	18,72	0,23	2,62	0,08	2-116
2-117	-117	13/16	1	3/32	.799	.010	.103	.003	.0236	20,29	0,25	2,62	0,08	2-117
2-118	-118	7/8	1-1/16	3/32	.862	.010	.103	.003	.0253	21,89	0,25	2,62	0,08	2-118
2-119	-119	15/16	1-1/8	3/32	.924	.010	.103	.003	.0269	23,47	0,25	2,62	0,08	2-119
2-120	-120	1	1-3/16	3/32	.987	.010	.103	.003	.0285	25,07	0,25	2,62	0,08	2-120
2-121	-121	1-1/16	1-1/4	3/32	1.049	.010	.103	.003	.0302	26,64	0,25	2,62	0,08	2-121
2-122	-122	1-1/8	1-5/16	3/32	1.112	.010	.103	.003	.0318	28,24	0,25	2,62	0,08	2-122
2-123	-123	1-3/16	1-3/8	3/32	1.174	.012	.103	.003	.0334	29,82	0,30	2,62	0,08	2-123
2-124	-124	1-1/4	1-7/16	3/32	1.237	.012	.103	.003	.0351	31,42	0,30	2,62	0,08	2-124
2-125	-125	1-5/16	1-1/2	3/32	1.299	.012	.103	.003	.0367	32,99	0,30	2,62	0,08	2-125
2-126	-126	1-3/8	1-9/16	3/32	1.362	.012	.103	.003	.0383	34,59	0,30	2,62	0,08	2-126
2-127	-127	1-7/16	1-5/8	3/32	1.424	.012	.103	.003	.0400	36,17	0,30	2,62	0,08	2-127
2-128	-128	1-1/2	1-11/16	3/32	1.487	.012	.103	.003	.0416	37,77	0,30	2,62	0,08	2-128
2-129	-129	1-9/16	1-3/4	3/32	1.549	.015	.103	.003	.0432	39,34	0,38	2,62	0,08	2-129
2-130	-130	1-5/8	1-13/16	3/32	1.612	.015	.103	.003	.0449	40,94	0,38	2,62	0,08	2-130
2-131	-131	1-11/16	1-7/8	3/32	1.674	.015	.103	.003	.0465	42,52	0,38	2,62	0,08	2-131

(a) The rubber compound must be added when ordering by the 2-size number (i.e., N0674-70 2-007).

(b) This chart provides dimensions for standard (AN) shrinkage materials ONLY. These correspond to AS568A dimensions.

O-rings manufactured out of compounds with different shrinkage rates (other than AN) will produce slightly different dimensions and tolerances. For more information on shrinkage rates, see the Appendix.

(c) When ordering O-rings to a Military, AMS or NAS material Specification, see Section VIII, Specifications, for more information.

Table 9-1: Parker Series 2-XXX O-Ring Sizes

WARNING: These products can expose you to chemicals including carbon black (airborne and extracts), antimony trioxide, titanium dioxide, silica (crystalline), di(2-ethylhexyl) phthalate, ethylene thiourea, acrylonitrile, 1,3-butadiene, epichlorohydrin, toluenediisocyanate, tetrafluoroethylene, ethylbenzene, formaldehyde, furfuryl alcohol, glass fibers, methyl isobutyl ketone, nickel (metallic and compounds), lead and lead compounds which are known to the State of California to cause cancer; and 1,3-butadiene, epichlorohydrin, di(2-ethylhexyl)phthalate, di-isodecyl phthalate, ethylene thiourea, methyl isobutyl ketone, methanol, toluene, lead and lead compounds which are known to the State of California to cause birth defects and other reproductive harm. For more information go to www.P65Warnings.ca.gov.

Parker Series 2-XXX O-Ring Sizes (Continued)

1 Parker Size No. (Size Only) (a)	2 Size Only AS 568A Uniform Dash No.	3 Nominal Size (Inches) (Ref. Only)			4 Standard O-Ring Size (Units are in Inches) Actual (b) Per AS 568A				5 (Ref. Only)	6 Metric O-Ring Size (Units are in Millimetres) Actual (b) Per AS 568A				7 Parker Size No. (Size Only) (a)
		I.D.	O.D.	W.	I.D.	Tolerance ±	W	±	Basic Volume Cu. In.	I.D.	Tolerance ±	W	±	
2-132	-132	1-3/4	1-15/16	3/32	1.737	.015	.103	.003	.0482	44,12	0,38	2,62	0,08	2-132
2-133	-133	1-13/16	2	3/32	1.799	.015	.103	.003	.0498	45,69	0,38	2,62	0,08	2-133
2-134	-134	1-7/8	2-1/16	3/32	1.862	.015	.103	.003	.0514	47,29	0,38	2,62	0,08	2-134
2-135	-135	1-15/16	2-1/8	3/32	1.925	.017	.103	.003	.0531	48,90	0,43	2,62	0,08	2-135
2-136	-136	2	2-3/16	3/32	1.987	.017	.103	.003	.0547	50,47	0,43	2,62	0,08	2-136
2-137	-137	2-1/16	2-1/4	3/32	2.050	.017	.103	.003	.0564	52,07	0,43	2,62	0,08	2-137
2-138	-138	2-1/8	2-5/16	3/32	2.112	.017	.103	.003	.0580	53,64	0,43	2,62	0,08	2-138
2-139	-139	2-3/16	2-3/8	3/32	2.175	.017	.103	.003	.0596	55,25	0,43	2,62	0,08	2-139
2-140	-140	2-1/4	2-7/16	3/32	2.237	.017	.103	.003	.0612	56,82	0,43	2,62	0,08	2-140
2-141	-141	2-5/16	2-1/2	3/32	2.300	.020	.103	.003	.0629	58,42	0,51	2,62	0,08	2-141
2-142	-142	2-3/8	2-9/16	3/32	2.362	.020	.103	.003	.0645	59,99	0,51	2,62	0,08	2-142
2-143	-143	2-7/16	2-5/8	3/32	2.425	.020	.103	.003	.0662	61,60	0,51	2,62	0,08	2-143
2-144	-144	2-1/2	2-11/16	3/32	2.487	.020	.103	.003	.0678	63,17	0,51	2,62	0,08	2-144
2-145	-145	2-9/16	2-3/4	3/32	2.550	.020	.103	.003	.0694	64,77	0,51	2,62	0,08	2-145
2-146	-146	2-5/8	2-13/16	3/32	2.612	.020	.103	.003	.0711	66,34	0,51	2,62	0,08	2-146
2-147	-147	2-11/16	2-7/8	3/32	2.675	.022	.103	.003	.0727	67,95	0,56	2,62	0,08	2-147
2-148	-148	2-3/4	2-15/16	3/32	2.737	.022	.103	.003	.0743	69,52	0,56	2,62	0,08	2-148
2-149	-149	2-13/16	3	3/32	2.800	.022	.103	.003	.0760	71,12	0,56	2,62	0,08	2-149
2-150	-150	2-7/8	3-1/16	3/32	2.862	.022	.103	.003	.0776	72,69	0,56	2,62	0,08	2-150
2-151	-151	3	3-3/16	3/32	2.987	.024	.103	.003	.0809	75,87	0,61	2,62	0,08	2-151
2-152	-152	3-1/4	3-7/16	3/32	3.237	.024	.103	.003	.0874	82,22	0,61	2,62	0,08	2-152
2-153	-153	3-1/2	3-11/16	3/32	3.487	.024	.103	.003	.0940	88,57	0,61	2,62	0,08	2-153
2-154	-154	3-3/4	3-15/16	3/32	3.737	.028	.103	.003	.1005	94,92	0,71	2,62	0,08	2-154
2-155	-155	4	4-3/16	3/32	3.987	.028	.103	.003	.1071	101,27	0,71	2,62	0,08	2-155
2-156	-156	4-1/4	4-7/16	3/32	4.237	.030	.103	.003	.1136	107,62	0,76	2,62	0,08	2-156
2-157	-157	4-1/2	4-11/16	3/32	4.487	.030	.103	.003	.1202	113,97	0,76	2,62	0,08	2-157
2-158	-158	4-3/4	4-15/16	3/32	4.737	.030	.103	.003	.1267	120,32	0,76	2,62	0,08	2-158
2-159	-159	5	5-3/16	3/32	4.987	.035	.103	.003	.1332	126,67	0,89	2,62	0,08	2-159
2-160	-160	5-1/4	5-7/16	3/32	5.237	.035	.103	.003	.1398	133,02	0,89	2,62	0,08	2-160
2-161	-161	5-1/2	5-11/16	3/32	5.487	.035	.103	.003	.1463	139,37	0,89	2,62	0,08	2-161
2-162	-162	5-3/4	5-15/16	3/32	5.737	.035	.103	.003	.1529	145,72	0,89	2,62	0,08	2-162
2-163	-163	6	6-3/16	3/32	5.987	.035	.103	.003	.1594	152,07	0,89	2,62	0,08	2-163
2-164	-164	6-1/4	6-7/16	3/32	6.237	.040	.103	.003	.1660	158,42	1,02	2,62	0,08	2-164
2-165	-165	6-1/2	6-11/16	3/32	6.487	.040	.103	.003	.1725	164,77	1,02	2,62	0,08	2-165
2-166	-166	6-3/4	6-15/16	3/32	6.737	.040	.103	.003	.1790	171,12	1,02	2,62	0,08	2-166
2-167	-167	7	7-3/16	3/32	6.987	.040	.103	.003	.1856	177,47	1,02	2,62	0,08	2-167
2-168	-168	7-1/4	7-7/16	3/32	7.237	.045	.103	.003	.1921	183,82	1,14	2,62	0,08	2-168
2-169	-169	7-1/2	7-11/16	3/32	7.487	.045	.103	.003	.1987	190,17	1,14	2,62	0,08	2-169
2-170	-170	7-3/4	7-15/16	3/32	7.737	.045	.103	.003	.2052	196,52	1,14	2,62	0,08	2-170
2-171	-171	8	8-3/16	3/32	7.987	.045	.103	.003	.2118	202,87	1,14	2,62	0,08	2-171

- (a) The rubber compound must be added when ordering by the 2-size number (i.e., N0674-70 2-007). .103 Area = .008332 (sq. in.)
- (b) This chart provides dimensions for standard (AN) shrinkage materials ONLY. These correspond to AS568A dimensions.
- O-rings manufactured out of compounds with different shrinkage rates (other than AN) will produce slightly different dimensions and tolerances. For more information on shrinkage rates, see the Appendix.
- (c) When ordering O-rings to a Military, AMS or NAS material Specification, see Section VIII, Specifications, for more information.

Table 9-1: Parker Series 2-XXX O-Ring Sizes

WARNING: These products can expose you to chemicals including carbon black (airborne and extracts), antimony trioxide, titanium dioxide, silica (crystalline), di(2-ethylhexyl) phthalate, ethylene thiourea, acrylonitrile, 1,3-butadiene, epichlorohydrin, toluenediisocyanate, tetrafluoroethylene, ethylbenzene, formaldehyde, furfuryl alcohol, glass fibers, methyl isobutyl ketone, nickel (metallic and compounds), lead and lead compounds which are known to the State of California to cause cancer; and 1,3-butadiene, epichlorohydrin, di(2-ethylhexyl)phthalate, di-isodecyl phthalate, ethylene thiourea, methyl isobutyl ketone, methanol, toluene, lead and lead compounds which are known to the State of California to cause birth defects and other reproductive harm. For more information go to www.P65Warnings.ca.gov.

Parker Series 2-XXX O-Ring Sizes (Continued)

1 Parker Size No. (Size Only) (a)	2 Size Only AS 568A Uniform Dash No.	3 Nominal Size (Inches) (Ref. Only)			4 Standard O-Ring Size (Units are in Inches) Actual (b) Per AS 568A				5 (Ref. Only)	6 Metric O-Ring Size (Units are in Millimetres) Actual (b) Per AS 568A				7 Parker Size No. (Size Only) (a)
		I.D.	O.D.	W.	I.D.	Tolerance ±	W	±	Basic Volume Cu. In.	I.D.	Tolerance ±	W	±	
2-172	-172	8-1/4	8-7/16	3/32	8.237	.050	.103	.003	.2183	209,22	1,27	2,62	0,08	2-172
2-173	-173	8-1/2	8-11/16	3/32	8.487	.050	.103	.003	.2249	215,57	1,27	2,62	0,08	2-173
2-174	-174	8-3/4	8-15/16	3/32	8.737	.050	.103	.003	.2314	221,92	1,27	2,62	0,08	2-174
2-175	-175	9	9-3/16	3/32	8.987	.050	.103	.003	.2379	228,27	1,27	2,62	0,08	2-175
2-176	-176	9-1/4	9-7/16	3/32	9.237	.055	.103	.003	.2445	234,62	1,40	2,62	0,08	2-176
2-177	-177	9-1/2	9-11/16	3/32	9.487	.055	.103	.003	.2510	240,97	1,40	2,62	0,08	2-177
2-178	-178	9-3/4	9-15/16	3/32	9.737	.055	.103	.003	.2576	247,32	1,40	2,62	0,08	2-178
2-201	-201	3/16	7/16	1/8	.171	.055	.139	.004	.0148	4,34	0,13	3,53	0,10	2-201
2-202	-202	1/4	1/2	1/8	.234	.005	.139	.004	.0178	5,94	0,13	3,53	0,10	2-202
2-203	-203	5/16	9/16	1/8	.296	.005	.139	.004	.0207	7,52	0,13	3,53	0,10	2-203
2-204	-204	3/8	5/8	1/8	.359	.005	.139	.004	.0237	9,12	0,13	3,53	0,10	2-204
2-205	-205	7/16	11/16	1/8	.421	.005	.139	.004	.0267	10,69	0,13	3,53	0,10	2-205
2-206	-206	1/2	3/4	1/8	.484	.005	.139	.004	.0297	12,29	0,13	3,53	0,10	2-206
2-207	-207	9/16	13/16	1/8	.546	.007	.139	.004	.0327	13,87	0,18	3,53	0,10	2-207
2-208	-208	5/8	7/8	1/8	.609	.009	.139	.004	.0357	15,47	0,23	3,53	0,10	2-208
2-209	-209	11/16	15/16	1/8	.671	.010	.139	.004	.0386	17,04	0,23	3,53	0,10	2-209
2-210	-210	3/4	1	1/8	.734	.010	.139	.004	.0416	18,64	0,25	3,53	0,10	2-210
2-211	-211	13/16	1-1/16	1/8	.796	.010	.139	.004	.0446	20,22	0,25	3,53	0,10	2-211
2-212	-212	7/8	1-1/8	1/8	.859	.010	.139	.004	.0476	21,82	0,25	3,53	0,10	2-212
2-213	-213	15/16	1-3/16	1/8	.921	.010	.139	.004	.0505	23,39	0,25	3,53	0,10	2-213
2-214	-214	1	1-1/4	1/8	.984	.010	.139	.004	.0535	24,99	0,25	3,53	0,10	2-214
2-215	-215	1-1/16	1-5/16	1/8	1.046	.010	.139	.004	.0565	26,57	0,25	3,53	0,10	2-215
2-216	-216	1-1/8	1-3/8	1/8	1.109	.012	.139	.004	.0595	28,17	0,30	3,53	0,10	2-216
2-217	-217	1-3/16	1-7/16	1/8	1.171	.012	.139	.004	.0624	29,74	0,30	3,53	0,10	2-217
2-218	-218	1-1/4	1-1/2	1/8	1.234	.012	.139	.004	.0654	31,34	0,30	3,53	0,10	2-218
2-219	-219	1-5/16	1-9/16	1/8	1.296	.012	.139	.004	.0684	32,92	0,30	3,53	0,10	2-219
2-220	-220	1-3/8	1-5/8	1/8	1.359	.012	.139	.004	.0714	34,52	0,30	3,53	0,10	2-220
2-221	-221	1-7/16	1-11/16	1/8	1.421	.012	.139	.004	.0744	36,09	0,30	3,53	0,10	2-221
2-222	-222	1-1/2	1-3/4	1/8	1.484	.015	.139	.004	.0774	37,69	0,38	3,53	0,10	2-222
2-223	-223	1-5/8	1-7/8	1/8	1.609	.015	.139	.004	.0833	40,87	0,38	3,53	0,10	2-223
2-224	-224	1-3/4	2	1/8	1.734	.015	.139	.004	.0893	44,04	0,38	3,53	0,10	2-224
2-225	-225	1-7/8	2-1/8	1/8	1.859	.018	.139	.004	.0952	47,22	0,46	3,53	0,10	2-225
2-226	-226	2	2-1/4	1/8	1.984	.018	.139	.004	.1012	50,39	0,46	3,53	0,10	2-226
2-227	-227	2-1/16	2-3/8	1/8	2.109	.018	.139	.004	.1072	53,57	0,46	3,53	0,10	2-227
2-228	-228	2-1/4	2-1/2	1/8	2.234	.020	.139	.004	.1131	56,74	0,51	3,53	0,10	2-228
2-229	-229	2-3/8	2-5/8	1/8	2.359	.020	.139	.004	.1191	59,92	0,51	3,53	0,10	2-229
2-230	-230	2-1/2	2-3/4	1/8	2.484	.020	.139	.004	.1250	63,09	0,51	3,53	0,10	2-230
2-231	-231	2-5/8	2-7/8	1/8	2.609	.020	.139	.004	.1310	66,27	0,51	3,53	0,10	2-231
2-232	-232	2-3/4	3	1/8	2.734	.024	.139	.004	.1370	69,44	0,61	3,53	0,10	2-232
2-233	-233	2-7/8	3-1/8	1/8	2.859	.024	.139	.004	.1429	72,62	0,61	3,53	0,10	2-233

- (a) The rubber compound must be added when ordering by the 2-size number (i.e., N0674-70 2-007). .103 Area = .008332
 (b) This chart provides dimensions for standard (AN) shrinkage materials ONLY. These correspond to AS568A dimensions. .139 Area = .015175
 O-rings manufactured out of compounds with different shrinkage rates (other than AN) will produce slightly different dimensions and tolerances. For more information on shrinkage rates, see the Appendix. (sq. in.)
 (c) When ordering O-rings to a Military, AMS or NAS material Specification, see Section VIII, Specifications, for more information.

Table 9-1: Parker Series 2-XXX O-Ring Sizes

WARNING: These products can expose you to chemicals including carbon black (airborne and extracts), antimony trioxide, titanium dioxide, silica (crystalline), di(2-ethylhexyl) phthalate, ethylene thiourea, acrylonitrile, 1,3-butadiene, epichlorohydrin, toluenediisocyanate, tetrafluoroethylene, ethylbenzene, formaldehyde, furfuryl alcohol, glass fibers, methyl isobutyl ketone, nickel (metallic and compounds), lead and lead compounds which are known to the State of California to cause cancer; and 1,3-butadiene, epichlorohydrin, di(2-ethylhexyl)phthalate, di-isodecyl phthalate, ethylene thiourea, methyl isobutyl ketone, methanol, toluene, lead and lead compounds which are known to the State of California to cause birth defects and other reproductive harm. For more information go to www.P65Warnings.ca.gov.

Parker Series 2-XXX O-Ring Sizes (Continued)

1 Parker Size No. (Size Only) (a)	2 Size Only AS 568A Uniform Dash No.	3 Nominal Size (Inches) (Ref. Only)			4 Standard O-Ring Size (Units are in Inches) Actual (b) Per AS 568A				5 (Ref. Only) Basic Volume Cu. In.	6 Metric O-Ring Size (Units are in Millimeters) Actual (b) Per AS 568A				7 Parker Size No. (Size Only) (a)
		I.D.	O.D.	W.	I.D.	Tolerance ±	W	±		I.D.	Tolerance ±	W	±	
2-234	-234	3	3-1/4	1/8	2.984	.024	.139	.004	.1489	75,79	0,61	3,53	0,10	2-234
2-235	-235	3-1/8	3-3/8	1/8	3.109	.024	.139	.004	.1548	78,97	0,61	3,53	0,10	2-235
2-236	-236	3-1/4	3-1/2	1/8	3.234	.024	.139	.004	.1608	82,14	0,61	3,53	0,10	2-236
2-237	-237	3-3/8	3-5/8	1/8	3.359	.024	.139	.004	.1668	85,32	0,61	3,53	0,10	2-237
2-238	-238	3-1/2	3-3/4	1/8	3.484	.024	.139	.004	.1727	88,49	0,61	3,53	0,10	2-238
2-239	-239	3-5/8	3-7/8	1/8	3.609	.028	.139	.004	.1787	91,67	0,71	3,53	0,10	2-239
2-240	-240	3-3/4	4	1/8	3.734	.028	.139	.004	.1846	94,84	0,71	3,53	0,10	2-240
2-241	-241	3-7/8	4-1/8	1/8	3.859	.028	.139	.004	.1906	98,02	0,71	3,53	0,10	2-241
2-242	-242	4	4-1/4	1/8	3.984	.028	.139	.004	.1966	101,19	0,71	3,53	0,10	2-242
2-243	-243	4-1/8	4-3/8	1/8	4.109	.028	.139	.004	.2025	104,37	0,71	3,53	0,10	2-243
2-244	-244	4-1/4	4-1/2	1/8	4.234	.030	.139	.004	.2085	107,54	0,76	3,53	0,10	2-244
2-245	-245	4-3/8	4-5/8	1/8	4.359	.030	.139	.004	.2144	110,72	0,76	3,53	0,10	2-245
2-246	-246	4-1/2	4-3/4	1/8	4.484	.030	.139	.004	.2204	113,89	0,76	3,53	0,10	2-246
2-247	-247	4-5/8	4-7/8	1/8	4.609	.030	.139	.004	.2264	117,07	0,76	3,53	0,10	2-247
2-248	-248	4-3/4	5	1/8	4.734	.030	.139	.004	.2323	120,24	0,76	3,53	0,10	2-248
2-249	-249	4-7/8	5-1/8	1/8	4.859	.035	.139	.004	.2383	123,42	0,89	3,53	0,10	2-249
2-250	-250	5	5-1/4	1/8	4.984	.035	.139	.004	.2442	126,59	0,89	3,53	0,10	2-250
2-251	-251	5-1/8	5-3/8	1/8	5.109	.035	.139	.004	.2502	129,77	0,89	3,53	0,10	2-251
2-252	-252	5-1/4	5-1/2	1/8	5.234	.035	.139	.004	.2561	132,94	0,89	3,53	0,10	2-252
2-253	-253	5-3/8	5-5/8	1/8	5.359	.035	.139	.004	.2621	136,12	0,89	3,53	0,10	2-253
2-254	-254	5-1/2	5-3/4	1/8	5.484	.035	.139	.004	.2681	139,29	0,89	3,53	0,10	2-254
2-255	-255	5-5/8	5-7/8	1/8	5.609	.035	.139	.004	.2740	142,47	0,89	3,53	0,10	2-255
2-256	-256	5-3/4	6	1/8	5.734	.035	.139	.004	.2800	145,64	0,89	3,53	0,10	2-256
2-257	-257	5-7/8	6-1/8	1/8	5.859	.035	.139	.004	.2859	148,82	0,89	3,53	0,10	2-257
2-258	-258	6	6-1/4	1/8	5.984	.035	.139	.004	.2919	151,99	0,89	3,53	0,10	2-258
2-259	-259	6-1/4	6-1/2	1/8	6.234	.040	.139	.004	.3038	158,34	1,02	3,53	0,10	2-259
2-260	-260	6-1/2	6-3/4	1/8	6.484	.040	.139	.004	.3157	164,69	1,02	3,53	0,10	2-260
2-261	-261	6-3/4	7	1/8	6.734	.040	.139	.004	.3277	171,04	1,02	3,53	0,10	2-261
2-262	-262	7	7-1/4	1/8	6.984	.040	.139	.004	.3396	177,39	1,02	3,53	0,10	2-262
2-263	-263	7-1/4	7-1/2	1/8	7.234	.045	.139	.004	.3515	183,74	1,14	3,53	0,10	2-263
2-264	-264	7-1/2	7-3/4	1/8	7.484	.045	.139	.004	.3634	190,09	1,14	3,53	0,10	2-264
2-265	-265	7-3/4	8	1/8	7.734	.045	.139	.004	.3753	196,44	1,14	3,53	0,10	2-265
2-266	-266	8	8-1/4	1/8	7.984	.045	.139	.004	.3872	202,79	1,14	3,53	0,10	2-266
2-267	-267	8-1/4	8-1/2	1/8	8.234	.050	.139	.004	.3992	209,14	1,27	3,53	0,10	2-267
2-268	-268	8-1/2	8-3/4	1/8	8.484	.050	.139	.004	.4111	215,49	1,27	3,53	0,10	2-268
2-269	-269	8-3/4	9	1/8	8.734	.050	.139	.004	.4230	221,84	1,27	3,53	0,10	2-269
2-270	-270	9	9-1/4	1/8	8.984	.050	.139	.004	.4349	228,19	1,27	3,53	0,10	2-270
2-271	-271	9-1/4	9-1/2	1/8	9.234	.055	.139	.004	.4468	234,54	1,40	3,53	0,10	2-271
2-272	-272	9-1/2	9-3/4	1/8	9.484	.055	.139	.004	.4588	240,89	1,40	3,53	0,10	2-272
2-273	-273	9-3/4	10	1/8	9.734	.055	.139	.004	.4707	247,24	1,40	3,53	0,10	2-273

- (a) The rubber compound must be added when ordering by the 2-size number (i.e., N0674-70 2-007). .139 Area = .015175 (sq. in.)
 (b) This chart provides dimensions for standard (AN) shrinkage materials ONLY. These correspond to AS568A dimensions.
 O-rings manufactured out of compounds with different shrinkage rates (other than AN) will produce slightly different dimensions and tolerances. For more information on shrinkage rates, see the Appendix.
 (c) When ordering O-rings to a Military, AMS or NAS material Specification, see Section VIII, Specifications, for more information.

Table 9-1: Parker Series 2-XXX O-Ring Sizes

WARNING: These products can expose you to chemicals including carbon black (airborne and extracts), antimony trioxide, titanium dioxide, silica (crystalline), di(2-ethylhexyl) phthalate, ethylene thiourea, acrylonitrile, 1,3-butadiene, epichlorohydrin, toluenediisocyanate, tetrafluoroethylene, ethylbenzene, formaldehyde, furfuryl alcohol, glass fibers, methyl isobutyl ketone, nickel (metallic and compounds), lead and lead compounds which are known to the State of California to cause cancer; and 1,3-butadiene, epichlorohydrin, di(2-ethylhexyl)phthalate, di-isodecyl phthalate, ethylene thiourea, methyl isobutyl ketone, methanol, toluene, lead and lead compounds which are known to the State of California to cause birth defects and other reproductive harm. For more information go to www.P65Warnings.ca.gov.

Parker Series 2-XXX O-Ring Sizes (Continued)

1 Parker Size No. (Size Only) (a)	2 Size Only AS 568A Uniform Dash No.	3 Nominal Size (Inches) (Ref. Only)			4 Standard O-Ring Size (Units are in Inches) Actual (b) Per AS 568A				5 (Ref. Only) Basic Volume Cu. In.	6 Metric O-Ring Size (Units are in Millimetres) Actual (b) Per AS 568A				7 Parker Size No. (Size Only) (a)
		I.D.	O.D.	W.	I.D.	Tolerance ±	W	±		I.D.	Tolerance ±	W	±	
2-274	-274	10	10-1/4	1/8	9.984	.055	.139	.004	.4826	253,59	1,40	3,53	0,10	2-274
2-275	-275	10-1/2	10-3/4	1/8	10.484	.055	.139	.004	.5064	266,29	1,40	3,53	0,10	2-275
2-276	-276	11	11-1/4	1/8	10.984	.065	.139	.004	.5303	278,99	1,65	3,53	0,10	2-276
2-277	-277	11-1/2	11-3/4	1/8	11.484	.065	.139	.004	.5541	291,69	1,65	3,53	0,10	2-277
2-278	-278	12	12-1/4	1/8	11.984	.065	.139	.004	.5779	304,39	1,65	3,53	0,10	2-278
2-279	-279	13	13-1/4	1/8	12.984	.065	.139	.004	.6256	329,79	1,65	3,53	0,10	2-279
2-280	-280	14	14-1/4	1/8	13.984	.065	.139	.004	.6733	355,19	1,65	3,53	0,10	2-280
2-281	-281	15	15-1/4	1/8	14.984	.065	.139	.004	.7210	380,59	1,65	3,53	0,10	2-281
2-282	-282	16	16-1/4	1/8	15.955	.075	.139	.004	.7672	405,26	1,91	3,53	0,10	2-282
2-283	-283	17	17-1/4	1/8	16.955	.080	.139	.004	.8149	430,66	2,03	3,53	0,10	2-283
2-284	-284	18	18-1/4	1/8	17.955	.085	.139	.004	.8626	456,06	2,16	3,53	0,10	2-284
2-309	-309	7/16	13/16	3/16	.412	.005	.210	.005	.0677	10,46	0,13	5,33	0,13	2-309
2-310	-310	1/2	7/8	3/16	.475	.005	.210	.005	.0745	12,07	0,13	5,33	0,13	2-310
2-311	-311	9/16	15/16	3/16	.537	.007	.210	.005	.0813	13,64	0,18	5,33	0,13	2-311
2-312	-312	5/8	1	3/16	.600	.009	.210	.005	.0881	15,24	0,23	5,33	0,13	2-312
2-313	-313	11/16	1-1/16	3/16	.662	.009	.210	.005	.0949	16,81	0,23	5,33	0,13	2-313
2-314	-314	3/4	1-1/8	3/16	.725	.010	.210	.005	.1017	18,42	0,25	5,33	0,13	2-314
2-315	-315	13/16	1-3/16	3/16	.787	.010	.210	.005	.1085	19,99	0,25	5,33	0,13	2-315
2-316	-316	7/8	1-1/4	3/16	.850	.010	.210	.005	.1153	21,59	0,25	5,33	0,13	2-316
2-317	-317	15/16	1-5/16	3/16	.912	.010	.210	.005	.1221	23,16	0,25	5,33	0,13	2-317
2-318	-318	1	1-3/8	3/16	.975	.010	.210	.005	.1289	24,77	0,25	5,33	0,13	2-318
2-319	-319	1-1/16	1-7/16	3/16	1.037	.010	.210	.005	.1357	26,34	0,25	5,33	0,13	2-319
2-320	-320	1-1/8	1-1/2	3/16	1.100	.012	.210	.005	.1425	27,94	0,30	5,33	0,13	2-320
2-321	-321	1-3/16	1-9/16	3/16	1.162	.012	.210	.005	.1493	29,51	0,30	5,33	0,13	2-321
2-322	-322	1-1/4	1-5/8	3/16	1.225	.012	.210	.005	.1561	31,12	0,30	5,33	0,13	2-322
2-323	-323	1-5/16	1-11/16	3/16	1.287	.012	.210	.005	.1629	32,69	0,30	5,33	0,13	2-323
2-324	-324	1-3/8	1-3/4	3/16	1.350	.012	.210	.005	.1697	34,29	0,30	5,33	0,13	2-324
2-325	-325	1-1/2	1-7/8	3/16	1.475	.015	.210	.005	.1833	37,47	0,38	5,33	0,13	2-325
2-326	-326	1-5/8	2	3/16	1.600	.015	.210	.005	.1970	40,64	0,38	5,33	0,13	2-326
2-327	-327	1-3/4	2-1/8	3/16	1.725	.015	.210	.005	.2106	43,82	0,38	5,33	0,13	2-327
2-328	-328	1-7/8	2-1/4	3/16	1.850	.015	.210	.005	.2242	46,99	0,38	5,33	0,13	2-328
2-329	-329	2	2-3/8	3/16	1.975	.018	.210	.005	.2378	50,17	0,46	5,33	0,13	2-329
2-330	-330	2-1/8	2-1/2	3/16	2.100	.018	.210	.005	.2514	53,34	0,46	5,33	0,13	2-330
2-331	-331	2-1/4	2-5/8	3/16	2.225	.018	.210	.005	.2650	56,52	0,46	5,33	0,13	2-331
2-332	-332	2-3/8	2-3/4	3/16	2.350	.018	.210	.005	.2786	59,69	0,46	5,33	0,13	2-332
2-333	-333	2-1/2	2-7/8	3/16	2.475	.020	.210	.005	.2922	62,87	0,51	5,33	0,13	2-333
2-334	-334	2-5/8	3	3/16	2.600	.020	.210	.005	.3058	66,04	0,51	5,33	0,13	2-334
2-335	-335	2-3/4	3-1/8	3/16	2.725	.020	.210	.005	.3194	69,22	0,51	5,33	0,13	2-335
2-336	-336	2-7/8	3-1/4	3/16	2.850	.020	.210	.005	.3330	72,39	0,51	5,33	0,13	2-336
2-337	-337	3	3-3/8	3/16	2.975	.024	.210	.005	.3466	75,57	0,61	5,33	0,13	2-337

- (a) The rubber compound must be added when ordering by the 2-size number (i.e., N0674-70 2-007). .139 Area = .015175
- (b) This chart provides dimensions for standard (AN) shrinkage materials ONLY. These correspond to AS568A dimensions. .210 Area = .034636
 O-rings manufactured out of compounds with different shrinkage rates (other than AN) will produce slightly different dimensions and tolerances. For more information on shrinkage rates, see the Appendix. (sq. in.)
- (c) When ordering O-rings to a Military, AMS or NAS material Specification, see Section VIII, Specifications, for more information.

Table 9-1: Parker Series 2-XXX O-Ring Sizes

WARNING: These products can expose you to chemicals including carbon black (airborne and extracts), antimony trioxide, titanium dioxide, silica (crystalline), di(2-ethylhexyl) phthalate, ethylene thiourea, acrylonitrile, 1,3-butadiene, epichlorohydrin, toluenediisocyanate, tetrafluoroethylene, ethylbenzene, formaldehyde, furfuryl alcohol, glass fibers, methyl isobutyl ketone, nickel (metallic and compounds), lead and lead compounds which are known to the State of California to cause cancer; and 1,3-butadiene, epichlorohydrin, di(2-ethylhexyl)phthalate, di-isodecyl phthalate, ethylene thiourea, methyl isobutyl ketone, methanol, toluene, lead and lead compounds which are known to the State of California to cause birth defects and other reproductive harm. For more information go to www.P65Warnings.ca.gov.

Parker Series 2-XXX O-Ring Sizes (Continued)

1 Parker Size No. (Size Only) (a)	2 Size Only AS 568A Uniform Dash No.	3 Nominal Size (Inches) (Ref. Only)			4 Standard O-Ring Size (Units are in Inches) Actual (b) Per AS 568A				5 (Ref. Only) Basic Volume Cu. In.	6 Metric O-Ring Size (Units are in Millimetres) Actual (b) Per AS 568A				7 Parker Size No. (Size Only) (a)
		I.D.	O.D.	W.	I.D.	Tolerance ±	W	±		I.D.	Tolerance ±	W	±	
2-338	-338	3-1/8	3-1/2	3/16	3.100	.024	.210	.005	.3602	78,74	0,61	5,33	0,13	2-338
2-339	-339	3-1/4	3-5/8	3/16	3.225	.024	.210	.005	.3738	81,92	0,61	5,33	0,13	2-339
2-340	-340	3-3/8	3-3/4	3/16	3.350	.024	.210	.005	.3874	85,09	0,61	5,33	0,13	2-340
2-341	-341	3-1/2	3-7/8	3/16	3.475	.024	.210	.005	.4010	88,27	0,61	5,33	0,13	2-341
2-342	-342	3-5/8	4	3/16	3.600	.028	.210	.005	.4146	91,44	0,71	5,33	0,13	2-342
2-343	-343	3-3/4	4-1/8	3/16	3.725	.028	.210	.005	.4282	94,62	0,71	5,33	0,13	2-343
2-344	-344	3-7/8	4-1/4	3/16	3.850	.028	.210	.005	.4418	97,79	0,71	5,33	0,13	2-344
2-345	-345	4	4-3/8	3/16	3.975	.028	.210	.005	.4554	100,97	0,71	5,33	0,13	2-345
2-346	-346	4-1/8	4-1/2	3/16	4.100	.028	.210	.005	.4690	104,14	0,71	5,33	0,13	2-346
2-347	-347	4-1/4	4-5/8	3/16	4.225	.030	.210	.005	.4826	107,32	0,76	5,33	0,13	2-347
2-348	-348	4-3/8	4-3/4	3/16	4.350	.030	.210	.005	.4962	110,49	0,76	5,33	0,13	2-348
2-349	-349	4-1/2	4-7/8	3/16	4.475	.030	.210	.005	.5098	113,67	0,76	5,33	0,13	2-349
2-350	-350	4-5/8	5	3/16	4.600	.030	.210	.005	.5234	116,84	0,76	5,33	0,13	2-350
2-351	-351	4-3/4	5-1/8	3/16	4.725	.030	.210	.005	.5370	120,02	0,76	5,33	0,13	2-351
2-352	-352	4-7/8	5-1/4	3/16	4.850	.030	.210	.005	.5506	123,19	0,76	5,33	0,13	2-352
2-353	-353	5	5-3/8	3/16	4.975	.037	.210	.005	.5642	126,37	0,94	5,33	0,13	2-353
2-354	-354	5-1/8	5-1/2	3/16	5.100	.037	.210	.005	.5778	129,54	0,94	5,33	0,13	2-354
2-355	-355	5-1/4	5-5/8	3/16	5.225	.037	.210	.005	.5914	132,72	0,94	5,33	0,13	2-355
2-356	-356	5-3/8	5-3/4	3/16	5.350	.037	.210	.005	.6050	135,89	0,94	5,33	0,13	2-356
2-357	-357	5-1/2	5-7/8	3/16	5.475	.037	.210	.005	.6186	139,07	0,94	5,33	0,13	2-357
2-358	-358	5-5/8	6	3/16	5.600	.037	.210	.005	.6322	142,24	0,94	5,33	0,13	2-358
2-359	-359	5-3/4	6-1/8	3/16	5.725	.037	.210	.005	.6458	145,42	0,94	5,33	0,13	2-359
2-360	-360	5-7/8	6-1/4	3/16	5.850	.037	.210	.005	.6594	148,59	0,94	5,33	0,13	2-360
2-361	-361	6	6-3/8	3/16	5.975	.037	.210	.005	.6730	151,77	0,94	5,33	0,13	2-361
2-362	-362	6-1/4	6-5/8	3/16	6.225	.040	.210	.005	.7002	158,12	1,02	5,33	0,13	2-362
2-363	-363	6-1/2	6-7/8	3/16	6.475	.040	.210	.005	.7274	164,47	1,02	5,33	0,13	2-363
2-364	-364	6-3/4	7-1/8	3/16	6.725	.040	.210	.005	.7546	170,82	1,02	5,33	0,13	2-364
2-365	-365	7	7-3/8	3/16	6.975	.040	.210	.005	.7818	177,17	1,02	5,33	0,13	2-365
2-366	-366	7-1/4	7-5/8	3/16	7.225	.045	.210	.005	.8090	183,52	1,14	5,33	0,13	2-366
2-367	-367	7-1/2	7-7/8	3/16	7.475	.045	.210	.005	.8362	189,87	1,14	5,33	0,13	2-367
2-368	-368	7-3/4	8-1/8	3/16	7.725	.045	.210	.005	.8634	196,22	1,14	5,33	0,13	2-368
2-369	-369	8	8-3/8	3/16	7.975	.045	.210	.005	.8906	202,57	1,14	5,33	0,13	2-369
2-370	-370	8-1/4	8-5/8	3/16	8.225	.050	.210	.005	.9178	208,92	1,27	5,33	0,13	2-370
2-371	-371	8-1/2	8-7/8	3/16	8.475	.050	.210	.005	.9450	215,27	1,27	5,33	0,13	2-371
2-372	-372	8-3/4	9-1/8	3/16	8.725	.050	.210	.005	.9722	221,62	1,27	5,33	0,13	2-372
2-373	-373	9	9-3/8	3/16	8.975	.050	.210	.005	.9994	227,97	1,27	5,33	0,13	2-373
2-374	-374	9-1/4	9-5/8	3/16	9.225	.055	.210	.005	1.0266	234,32	1,40	5,33	0,13	2-374
2-375	-375	9-1/2	9-7/8	3/16	9.475	.055	.210	.005	1.0538	240,67	1,40	5,33	0,13	2-375
2-376	-376	9-3/4	10-1/8	3/16	9.725	.055	.210	.005	1.0810	247,02	1,40	5,33	0,13	2-376
2-377	-377	10	10-3/8	3/16	9.975	.055	.210	.005	1.1083	253,37	1,40	5,33	0,13	2-377

- (a) The rubber compound must be added when ordering by the 2-size number (i.e., N0674-70 2-007). .210 Area = .034636
- (b) This chart provides dimensions for standard (AN) shrinkage materials ONLY. These correspond to AS568A dimensions. (sq. in.)
- O-rings manufactured out of compounds with different shrinkage rates (other than AN) will produce slightly different dimensions and tolerances. For more information on shrinkage rates, see the Appendix.
- (c) When ordering O-rings to a Military, AMS or NAS material Specification, see Section VIII, Specifications, for more information.

Table 9-1: Parker Series 2-XXX O-Ring Sizes

WARNING: These products can expose you to chemicals including carbon black (airborne and extracts), antimony trioxide, titanium dioxide, silica (crystalline), di(2-ethylhexyl) phthalate, ethylene thiourea, acrylonitrile, 1,3-butadiene, epichlorohydrin, toluenediisocyanate, tetrafluoroethylene, ethylbenzene, formaldehyde, furfuryl alcohol, glass fibers, methyl isobutyl ketone, nickel (metallic and compounds), lead and lead compounds which are known to the State of California to cause cancer; and 1,3-butadiene, epichlorohydrin, di(2-ethylhexyl)phthalate, di-isodecyl phthalate, ethylene thiourea, methyl isobutyl ketone, methanol, toluene, lead and lead compounds which are known to the State of California to cause birth defects and other reproductive harm. For more information go to www.P65Warnings.ca.gov.

Parker Series 2-XXX O-Ring Sizes (Continued)

1 Parker Size No. (Size Only) (a)	2 Size Only AS 568A Uniform Dash No.	3 Nominal Size (Inches) (Ref. Only)			4 Standard O-Ring Size (Units are in Inches) Actual (b) Per AS 568A				5 (Ref. Only) Basic Volume Cu. In.	6 Metric O-Ring Size (Units are in Millimetres) Actual (b) Per AS 568A				7 Parker Size No. (Size Only) (a)
		I.D.	O.D.	W.	I.D.	Tolerance ±	W	±		I.D.	Tolerance ±	W	±	
2-378	-378	10-1/2	10-7/8	3/16	10.475	.060	.210	.005	1.1627	266,07	1,52	5,33	0,13	2-378
2-379	-379	11	11-3/8	3/16	10.975	.060	.210	.005	1.2171	278,77	1,52	5,33	0,13	2-379
2-380	-380	11-1/2	11-7/8	3/16	11.475	.065	.210	.005	1.2715	291,47	1,65	5,33	0,13	2-380
2-381	-381	12	12-3/8	3/16	11.975	.065	.210	.005	1.3259	304,17	1,65	5,33	0,13	2-381
2-382	-382	13	13-3/8	3/16	12.975	.065	.210	.005	1.4347	329,57	1,65	5,33	0,13	2-382
2-383	-383	14	14-3/8	3/16	13.975	.070	.210	.005	1.5435	354,97	1,78	5,33	0,13	2-383
2-384	-384	15	15-3/8	3/16	14.975	.070	.210	.005	1.6523	380,37	1,78	5,33	0,13	2-384
2-385	-385	16	16-3/8	3/16	15.955	.075	.210	.005	1.7590	405,26	1,91	5,33	0,13	2-385
2-386	-386	17	17-3/8	3/16	16.955	.080	.210	.005	1.8678	430,66	2,03	5,33	0,13	2-386
2-387	-387	18	18-3/8	3/16	17.955	.085	.210	.005	1.9766	456,06	2,16	5,33	0,13	2-387
2-388	-388	19	19-3/8	3/16	18.955	.090	.210	.005	2.0854	481,46	2,29	5,33	0,13	2-388
2-389	-389	20	20-3/8	3/16	19.955	.095	.210	.005	2.1942	506,86	2,41	5,33	0,13	2-389
2-390	-390	21	21-3/8	3/16	20.955	.095	.210	.005	2.3030	532,26	2,41	5,33	0,13	2-390
2-391	-391	22	22-3/8	3/16	21.955	.100	.210	.005	2.4118	557,66	2,54	5,33	0,13	2-391
2-392	-392	23	23-3/8	3/16	22.940	.105	.210	.005	2.5190	582,68	2,67	5,33	0,13	2-392
2-393	-393	24	24-3/8	3/16	23.940	.110	.210	.005	2.6278	608,08	2,79	5,33	0,13	2-393
2-394	-394	25	25-3/8	3/16	24.940	.115	.210	.005	2.7366	633,48	2,92	5,33	0,13	2-394
2-395	-395	26	26-3/8	3/16	25.940	.120	.210	.005	2.8454	658,88	3,05	5,33	0,13	2-395
2-425	-425	4-1/2	5	1/4	4.475	.033	.275	.006	.8863	113,67	0,84	6,99	0,15	2-425
2-426	-426	4-5/8	5-1/8	1/4	4.600	.033	.275	.006	.9097	116,84	0,84	6,99	0,15	2-426
2-427	-427	4-3/4	5-1/4	1/4	4.725	.033	.275	.006	.9330	120,02	0,84	6,99	0,15	2-427
2-428	-428	4-7/8	5-3/8	1/4	4.850	.033	.275	.006	.9563	123,19	0,84	6,99	0,15	2-428
2-429	-429	5	5-1/2	1/4	4.975	.037	.275	.006	.9796	126,37	0,94	6,99	0,15	2-429
2-430	-430	5-1/8	5-5/8	1/4	5.100	.037	.275	.006	1.0030	129,54	0,94	6,99	0,15	2-430
2-431	-431	5-1/4	5-3/4	1/4	5.225	.037	.275	.006	1.0263	132,72	0,94	6,99	0,15	2-431
2-432	-432	5-3/8	5-7/8	1/4	5.350	.037	.275	.006	1.0496	135,89	0,94	6,99	0,15	2-432
2-433	-433	5-1/2	6	1/4	5.475	.037	.275	.006	1.0729	139,07	0,94	6,99	0,15	2-433
2-434	-434	5-5/8	6-1/8	1/4	5.600	.037	.275	.006	1.0963	142,24	0,94	6,99	0,15	2-434
2-435	-435	5-3/4	6-1/4	1/4	5.725	.037	.275	.006	1.1196	145,42	0,94	6,99	0,15	2-435
2-436	-436	5-7/8	6-3/8	1/4	5.850	.037	.275	.006	1.1429	148,59	0,94	6,99	0,15	2-436
2-437	-437	6	6-1/2	1/4	5.975	.037	.275	.006	1.1662	151,77	0,94	6,99	0,15	2-437
2-438	-438	6-1/4	6-3/4	1/4	6.225	.040	.275	.006	1.2129	158,12	1,02	6,99	0,15	2-438
2-439	-439	6-1/2	7	1/4	6.475	.040	.275	.006	1.2595	164,47	1,02	6,99	0,15	2-439
2-440	-440	6-3/4	7-1/4	1/4	6.725	.040	.275	.006	1.3062	170,82	1,02	6,99	0,15	2-440
2-441	-441	7	7-1/2	1/4	6.975	.040	.275	.006	1.3528	177,17	1,02	6,99	0,15	2-441
2-442	-442	7-1/4	7-3/4	1/4	7.225	.045	.275	.006	1.3995	183,52	1,14	6,99	0,15	2-442
2-443	-443	7-1/2	8	1/4	7.475	.045	.275	.006	1.4461	189,87	1,14	6,99	0,15	2-443
2-444	-444	7-3/4	8-1/4	1/4	7.725	.045	.275	.006	1.4928	196,22	1,14	6,99	0,15	2-444
2-445	-445	8	8-1/2	1/4	7.975	.045	.275	.006	1.5394	202,57	1,14	6,99	0,15	2-445
2-446	-446	8-1/2	9	1/4	8.475	.055	.275	.006	1.6327	215,27	1,40	6,99	0,15	2-446

- (a) The rubber compound must be added when ordering by the 2-size number (i.e., N0674-70 2-007). .210 Area = .034636
 (b) This chart provides dimensions for standard (AN) shrinkage materials ONLY. These correspond to AS568A dimensions. .275 Area = .059396
 O-rings manufactured out of compounds with different shrinkage rates (other than AN) will produce slightly different dimensions and tolerances. For more information on shrinkage rates, see the Appendix. (sq. in.)
 (c) When ordering O-rings to a Military, AMS or NAS material Specification, see Section VIII, Specifications, for more information.

Table 9-1: Parker Series 2-XXX O-Ring Sizes

WARNING: These products can expose you to chemicals including carbon black (airborne and extracts), antimony trioxide, titanium dioxide, silica (crystalline), di(2-ethylhexyl) phthalate, ethylene thiourea, acrylonitrile, 1,3-butadiene, epichlorohydrin, toluenediisocyanate, tetrafluoroethylene, ethylbenzene, formaldehyde, furfuryl alcohol, glass fibers, methyl isobutyl ketone, nickel (metallic and compounds), lead and lead compounds which are known to the State of California to cause cancer; and 1,3-butadiene, epichlorohydrin, di(2-ethylhexyl)phthalate, di-isodecyl phthalate, ethylene thiourea, methyl isobutyl ketone, methanol, toluene, lead and lead compounds which are known to the State of California to cause birth defects and other reproductive harm. For more information go to www.P65Warnings.ca.gov.

Parker Series 2-XXX O-Ring Sizes (Continued)

1 Parker Size No. (Size Only) (a)	2 Size Only AS 568A Uniform Dash No.	3 Nominal Size (Inches) (Ref. Only)			4 Standard O-Ring Size (Units are in Inches) Actual (b) Per AS 568A				5 (Ref. Only) Basic Volume Cu. In.	6 Metric O-Ring Size (Units are in Millimeteres) Actual (b) Per AS 568A				7 Parker Size No. (Size Only) (a)
		I.D.	O.D.	W.	I.D.	Tolerance ±	W	±		I.D.	Tolerance ±	W	±	
2-447	-447	9	9-1/2	1/4	8.975	.055	.275	.006	1.7260	227,97	1,40	6,99	0,15	2-447
2-448	-448	9-1/2	10	1/4	9.475	.055	.275	.006	1.8193	240,67	1,40	6,99	0,15	2-448
2-449	-449	10	10-1/2	1/4	9.975	.055	.275	.006	1.9126	253,37	1,40	6,99	0,15	2-449
2-450	-450	10-1/2	11	1/4	10.475	.060	.275	.006	2.0059	266,07	1,52	6,99	0,15	2-450
2-451	-451	11	11-1/2	1/4	10.975	.060	.275	.006	2.0992	278,77	1,52	6,99	0,15	2-451
2-452	-452	11 1/2	12	1/4	11.475	.060	.275	.006	2.1925	291,47	1,52	6,99	0,15	2-452
2-453	-453	12	12-1/2	1/4	11.975	.060	.275	.006	2.2858	304,17	1,52	6,99	0,15	2-453
2-454	-454	12-1/2	13	1/4	12.475	.060	.275	.006	2.3791	316,87	1,52	6,99	0,15	2-454
2-455	-455	13	13-1/2	1/4	12.975	.060	.275	.006	2.4724	329,57	1,52	6,99	0,15	2-455
2-456	-456	13-1/2	14	1/4	13.475	.070	.275	.006	2.5657	342,27	1,78	6,99	0,15	2-456
2-457	-457	14	14-1/2	1/4	13.975	.070	.275	.006	2.6590	354,97	1,78	6,99	0,15	2-457
2-458	-458	14-1/2	15	1/4	14.475	.070	.275	.006	2.7523	367,67	1,78	6,99	0,15	2-458
2-459	-459	15	15-1/2	1/4	14.975	.070	.275	.006	2.8456	380,37	1,78	6,99	0,15	2-459
2-460	-460	15-1/2	16	1/4	15.475	.070	.275	.006	2.9389	393,07	1,78	6,99	0,15	2-460
2-461	-461	16	16-1/2	1/4	15.955	.075	.275	.006	3.0285	405,26	1,91	6,99	0,15	2-461
2-462	-462	16-1/2	17	1/4	16.455	.075	.275	.006	3.1218	417,96	1,91	6,99	0,15	2-462
2-463	-463	17	17-1/2	1/4	16.955	.080	.275	.006	3.2151	430,66	2,03	6,99	0,15	2-463
2-464	-464	17-1/2	18	1/4	17.455	.085	.275	.006	3.3084	443,36	2,16	6,99	0,15	2-464
2-465	-465	18	18-1/2	1/4	17.955	.085	.275	.006	3.4017	456,06	2,16	6,99	0,15	2-465
2-466	-466	18-1/2	19	1/4	18.455	.085	.275	.006	3.4950	468,76	2,16	6,99	0,15	2-466
2-467	-467	19	19-1/2	1/4	18.955	.090	.275	.006	3.5883	481,46	2,29	6,99	0,15	2-467
2-468	-468	19-1/2	20	1/4	19.455	.090	.275	.006	3.6816	494,16	2,29	6,99	0,15	2-468
2-469	-469	20	20-1/2	1/4	19.955	.095	.275	.006	3.7749	506,86	2,41	6,99	0,15	2-469
2-470	-470	21	21-1/2	1/4	20.955	.095	.275	.006	3.9615	532,26	2,41	6,99	0,15	2-470
2-471	-471	22	22-1/2	1/4	21.955	.100	.275	.006	4.1481	557,66	2,54	6,99	0,15	2-471
2-472	-472	23	23-1/2	1/4	22.940	.105	.275	.006	4.3319	582,68	2,67	6,99	0,15	2-472
2-473	-473	24	24-1/2	1/4	23.940	.110	.275	.006	4.5185	608,08	2,79	6,99	0,15	2-473
2-474	-474	25	25-1/2	1/4	24.940	.115	.275	.006	4.7051	633,48	2,92	6,99	0,15	2-474
2-475	-475	26	26-1/2	1/4	25.940	.120	.275	.006	4.8917	658,88	3,05	6,99	0,15	2-475

- (a) The rubber compound must be added when ordering by the 2-size number (i.e., N0674-70 2-007). .275 Area = .059396
 (b) This chart provides dimensions for standard (AN) shrinkage materials ONLY. These correspond to AS568A dimensions. (sq. in.)
 O-rings manufactured out of compounds with different shrinkage rates (other than AN) will produce slightly different dimensions and tolerances. For more information on shrinkage rates, see the Appendix.
 (c) When ordering O-rings to a Military, AMS or NAS material Specification, see Section VIII, Specifications, for more information.

Table 9-1: Parker Series 2-XXX O-Ring Sizes

WARNING: These products can expose you to chemicals including carbon black (airborne and extracts), antimony trioxide, titanium dioxide, silica (crystalline), di(2-ethylhexyl) phthalate, ethylene thiourea, acrylonitrile, 1,3-butadiene, epichlorohydrin, toluenediisocyanate, tetrafluoroethylene, ethylbenzene, formaldehyde, furfuryl alcohol, glass fibers, methyl isobutyl ketone, nickel (metallic and compounds), lead and lead compounds which are known to the State of California to cause cancer; and 1,3-butadiene, epichlorohydrin, di(2-ethylhexyl)phthalate, di-isodecyl phthalate, ethylene thiourea, methyl isobutyl ketone, methanol, toluene, lead and lead compounds which are known to the State of California to cause birth defects and other reproductive harm. For more information go to www.P65Warnings.ca.gov.

Parker Series 3-XXX O-Ring Sizes

These O-rings are intended for use with internal straight thread fluid connection bosses and tube fittings. Ref. MS33656, MS33657, SAE straight thread O-ring boss and mating swivel and adjustment style fittings.

1	2	3	4	5	6	7	8	9	10	11		
3-XXX (a) Size No.	AS568A Dash No.	Tube O.D. (Ref.)	O-Ring Size – Actual (b) per AS568A (Units are in Inches)				Basic Volume Cu. In.	Metric O-Ring Size per AS568A (b) (Units are in Millimeters)				3-XXX (a) Size No.
			I.D.	Tolerance ±	W	±		I.D.	Tolerance ±	W	±	
3-901	-901	3/32	.185	.005	.056	.003	.0019	4,70	0,13	1,42	0,08	3-901
3-902	-902	1/8	.239	.005	.064	.003	.0031	6,07	0,13	1,63	0,08	3-902
3-903	-903	3/16	.301	.005	.064	.003	.0037	7,65	0,13	1,63	0,08	3-903
3-904	-904	1/4	.351	.005	.072	.003	.0055	8,92	0,13	1,83	0,08	3-904
3-905	-905	5/16	.414	.005	.072	.003	.0063	10,52	0,13	1,83	0,08	3-905
3-906	-906	3/8	.468	.005	.078	.003	.0082	11,89	0,13	1,98	0,08	3-906
3-907	-907	7/16	.530	.007	.082	.003	.0102	13,46	0,18	2,08	0,08	3-907
3-908	-908	1/2	.644	.009	.087	.003	.0137	16,36	0,23	2,21	0,08	3-908
3-909	-909	9/16	.706	.009	.097	.003	.0187	17,93	0,23	2,46	0,08	3-909
3-910	-910	5/8	.755	.009	.097	.003	.0198	19,18	0,23	2,46	0,08	3-910
3-911	-911	11/16	.863	.009	.116	.004	.0326	21,92	0,23	2,95	0,10	3-911
3-912	-912	3/4	.924	.009	.116	.004	.0346	23,47	0,23	2,95	0,10	3-912
3-913	-913	13/16	.986	.010	.116	.004	.0366	25,04	0,26	2,95	0,10	3-913
3-914	-914	7/8	1.047	.010	.116	.004	.0387	26,59	0,26	2,95	0,10	3-914
3-916	-916	1	1.171	.010	.116	.004	.0428	29,74	0,26	2,95	0,10	3-916
3-918	-918	1-1/8	1.355	.012	.116	.004	.0489	34,42	0,30	2,95	0,10	3-918
3-920	-920	1-1/4	1.475	.014	.118	.004	.0548	37,47	0,36	3,00	0,10	3-920
3-924	-924	1-1/2	1.720	.014	.118	.004	.0632	43,69	0,36	3,00	0,10	3-924
3-928	-928	1-3/4	2.090	.018	.118	.004	.0759	53,09	0,46	3,00	0,10	3-928
3-932	-932	2	2.337	.018	.118	.004	.0844	59,36	0,46	3,00	0,10	3-932

(a) The rubber compound must be added when ordering by the 3-size number (i.e., N552-90 3-910).

(b) This chart provides dimensions for standard (AN) shrinkage materials ONLY. These correspond to AS568A dimensions. O-rings manufactured out of compounds with different shrinkage rates (other than AN) will produce slightly different dimensions and tolerances. For more information on shrinkage rates, see the Appendix.

.056 Area = .00246
.064 Area = .00322
.072 Area = .00407
.078 Area = .00478
.082 Area = .00528
.087 Area = .00594
.097 Area = .00739
.116 Area = .01057
.118 Area = .01094
(sq. in.)

Table 9-2: Parker Series 3-XXX O-Rings Sizes

WARNING: These products can expose you to chemicals including carbon black (airborne and extracts), antimony trioxide, titanium dioxide, silica (crystalline), di(2-ethylhexyl) phthalate, ethylene thiourea, acrylonitrile, 1,3-butadiene, epichlorohydrin, toluenediisocyanate, tetrafluoroethylene, ethylbenzene, formaldehyde, furfuryl alcohol, glass fibers, methyl isobutyl ketone, nickel (metallic and compounds), lead and lead compounds which are known to the State of California to cause cancer; and 1,3-butadiene, epichlorohydrin, di(2-ethylhexyl)phthalate, di-isodecyl phthalate, ethylene thiourea, methyl isobutyl ketone, methanol, toluene, lead and lead compounds which are known to the State of California to cause birth defects and other reproductive harm. For more information go to www.P65Warnings.ca.gov.

Sizes

Parker Series 5-XXX O-Ring Sizes

The following 5-XXX sizes are O-rings of nonstandard dimensions for which Parker tooling was available as of January 1, 2007. This tooling will be maintained while volume demand continues. A mold scrapped as defective will not be replaced unless demand justifies the expense.

Note: These molds are cut to allow for standard “AN” shrinkage, and in materials having standard shrinkage they will normally produce rings to the dimensions listed. **Materials with other than standard shrinkage will give different dimensions and tolerances.** Please consult the factory or your local Parker Distributor for the availability of special sizes not included in this list as of this writing.

Parker Series 5-XXX O-Ring Sizes

Std 5-Size	Inches				Metric 5-Size	Millimeters				Std 5-Size	Inches				Metric 5-Size	Millimeters			
	I.D.	Tol ±	W.	Tol ±		I.D.	Tol ±	W	Tol ±		I.D.	Tol ±	W	Tol ±		I.D.	Tol ±	W	Tol ±
5-118	.059	.004	.040	.003	5-118	1.50	0.10	1.02	.08	5-204	.312	.005	.036	.003	5-204	7.92	0.13	0.91	.08
5-187	.070	.005	.036	.003	5-187	1.78	0.13	0.91	.08	5-205	.312	.005	.092	.003	5-205	7.92	0.13	2.34	.08
5-051	.070	.005	.040	.003	5-051	1.78	0.13	1.02	.08	5-160	.312	.005	.103	.003	5-160	7.92	0.13	2.62	.08
5-101	.100	.005	.038	.003	5-101	2.54	0.13	0.97	.08	5-712	.313	.005	.051	.003	5-712	7.95	0.13	1.30	.08
5-578	.102	.005	.074	.003	5-578	2.59	0.13	1.88	.08	5-585	.314	.005	.074	.003	5-585	7.98	0.13	1.88	.08
5-632	.110	.005	.040	.003	5-632	2.79	0.13	1.02	.08	5-664	.320	.005	.070	.003	5-664	8.13	0.13	1.78	.08
5-102	.116	.005	.038	.003	5-102	2.95	0.13	0.97	.08	5-1006	.322	.005	.070	.003	5-1006	8.18	0.13	1.78	.08
5-178	.120	.005	.040	.003	5-178	3.05	0.13	1.02	.08	5-206	.326	.005	.103	.003	5-206	8.28	0.13	2.62	.08
5-683	.122	.005	.063	.003	5-683	3.10	0.13	1.60	.08	5-1007	.330	.005	.050	.003	5-1007	8.38	0.13	1.27	.08
5-646	.126	.005	.040	.003	5-646	3.20	0.13	1.02	.08	5-133	.332	.005	.031	.003	5-133	8.43	0.13	0.79	.08
5-103	.128	.005	.050	.003	5-103	3.25	0.13	1.27	.08	5-612	.344	.005	.070	.003	5-612	8.74	0.13	1.78	.08
5-190	.132	.005	.070	.003	5-190	3.35	0.13	1.78	.08	5-586	.350	.005	.074	.003	5-586	8.89	0.13	1.88	.08
5-579	.133	.005	.074	.003	5-579	3.39	0.13	1.88	.08	5-587	.350	.005	.106	.004	5-587	8.89	0.13	2.69	.10
5-669	.146	.005	.040	.003	5-669	3.71	0.13	1.02	.08	5-018	.352	.005	.113	.004	5-018	8.94	0.13	2.87	.10
5-148	.154	.005	.038	.003	5-148	3.91	0.13	0.97	.08	5-699	.353	.005	.094	.003	5-699	8.97	0.13	2.39	.08
5-105	.154	.005	.050	.003	5-105	3.91	0.13	1.27	.08	5-700	.354	.005	.118	.004	5-700	8.99	0.13	3.00	.10
5-106	.154	.005	.066	.003	5-106	3.91	0.13	1.68	.08	5-716	.362	.005	.118	.004	5-716	9.19	0.13	3.00	.10
5-580	.165	.005	.074	.003	5-580	4.19	0.13	1.88	.08	5-057	.364	.005	.045	.003	5-057	9.25	0.13	1.14	.08
5-193	.176	.005	.040	.003	5-193	4.47	0.13	1.02	.08	5-209	.370	.005	.040	.003	5-209	9.40	0.13	1.02	.08
5-108	.176	.005	.050	.003	5-108	4.47	0.13	1.27	.08	5-211	.375	.005	.187	.005	5-211	9.53	0.13	4.75	.13
5-124	.176	.005	.056	.003	5-124	4.47	0.13	1.42	.08	5-212	.384	.005	.070	.003	5-212	9.75	0.13	1.78	.08
5-107	.176	.005	.066	.003	5-107	4.47	0.13	1.68	.08	5-614	.391	.005	.103	.003	5-614	9.93	0.13	2.62	.08
5-125	.180	.005	.040	.003	5-125	4.57	0.13	1.02	.08	5-718	.395	.005	.040	.003	5-718	10.03	0.13	1.02	.08
5-581	.192	.005	.074	.003	5-581	4.88	0.13	1.88	.08	5-134	.410	.005	.031	.003	5-134	10.41	0.13	0.79	.08
5-685	.208	.005	.094	.003	5-685	5.28	0.13	2.39	.08	5-588	.413	.005	.106	.004	5-588	10.49	0.13	2.69	.10
5-582	.224	.005	.074	.003	5-582	5.69	0.13	1.88	.08	5-002	.416	.005	.059	.003	5-002	10.57	0.13	1.50	.08
5-194	.228	.005	.040	.003	5-194	5.79	0.13	1.02	.08	5-215	.418	.005	.094	.003	5-215	10.62	0.13	2.39	.08
5-638	.233	.005	.076	.003	5-638	5.92	0.13	1.93	.08	5-218	.425	.005	.025	.003	5-218	10.80	0.13	0.64	.08
5-179	.239	.005	.040	.003	5-179	6.07	0.13	1.02	.08	5-682	.426	.005	.040	.003	5-682	10.82	0.13	1.02	.08
5-151	.239	.005	.051	.003	5-151	6.07	0.13	1.30	.08	5-058	.426	.005	.050	.003	5-058	10.82	0.13	1.27	.08
5-127	.239	.005	.074	.003	5-127	6.07	0.13	1.88	.08	5-613	.437	.005	.070	.003	5-613	11.10	0.13	1.78	.08
5-1002	.239	.005	.174	.005	5-1002	6.07	0.13	4.42	.13	5-1011	.447	.005	.103	.003	5-1011	11.35	0.13	2.62	.08
5-197	.242	.005	.040	.003	5-197	6.15	0.13	1.02	.08	5-222	.455	.005	.128	.004	5-222	11.56	0.13	3.25	.10
5-180	.248	.005	.048	.003	5-180	6.30	0.13	1.22	.08	5-223	.458	.005	.053	.003	5-223	11.63	0.13	1.35	.08
5-686	.248	.005	.094	.003	5-686	6.30	0.13	2.39	.08	5-225	.469	.006	.094	.003	5-225	11.91	0.15	2.39	.08
5-583	.251	.005	.074	.003	5-583	6.38	0.13	1.88	.08	5-615	.469	.006	.103	.003	5-615	11.91	0.15	2.62	.15
5-052	.270	.005	.070	.003	5-052	6.86	0.13	1.78	.08	5-652	.473	.006	.071	.003	5-652	12.01	0.15	1.80	.08
5-202	.278	.005	.046	.003	5-202	7.06	0.13	1.17	.08	5-726	.484	.006	.056	.003	5-726	12.29	0.15	1.42	.08
5-698	.283	.005	.040	.003	5-698	7.19	0.13	1.02	.08	5-566	.489	.006	.055	.003	5-566	12.42	0.15	1.40	.08
5-584	.283	.005	.074	.003	5-584	7.19	0.13	1.88	.08	5-230	.500	.006	.125	.004	5-230	12.70	0.15	3.18	.10
5-687	.287	.005	.094	.003	5-687	7.29	0.13	2.39	.08	5-231	.501	.006	.062	.003	5-231	12.73	0.15	1.57	.08
5-1004	.290	.005	.045	.003	5-1004	7.39	0.13	1.14	.08	5-675	.508	.006	.049	.003	5-675	12.90	0.15	1.24	.08
5-056	.301	.005	.038	.003	5-056	7.65	0.13	0.97	.08	5-616	.516	.006	.103	.003	5-616	13.11	0.15	2.62	.08
5-710	.301	.005	.054	.003	5-710	7.65	0.13	1.37	.08	5-1014	.525	.007	.071	.003	5-1014	13.34	0.18	1.80	.08
5-673	.305	.005	.074	.003	5-673	7.75	0.13	1.88	.08	5-135	.526	.007	.031	.003	5-135	13.36	0.18	0.79	.08

- (a) The rubber compound must be added when ordering by the 5-size number (i.e., N0674-70 5-007).
 (b) This chart provides dimensions for standard (AN) shrinkage materials ONLY. These correspond to AS568A dimensions. O-rings manufactured out of compounds with different shrinkage rates (other than AN) will produce slightly different dimensions and tolerances. For more information on shrinkage rates, see the Appendix.

Table 9-3: Parker Series 5-XXX O-Rings Size Cross Reference Table

WARNING: These products can expose you to chemicals including carbon black (airborne and extracts), antimony trioxide, titanium dioxide, silica (crystalline), di(2-ethylhexyl) phthalate, ethylene thiourea, acrylonitrile, 1,3-butadiene, epichlorohydrin, toluenediisocyanate, tetrafluoroethylene, ethylbenzene, formaldehyde, furfuryl alcohol, glass fibers, methyl isobutyl ketone, nickel (metallic and compounds), lead and lead compounds which are known to the State of California to cause cancer; and 1,3-butadiene, epichlorohydrin, di(2-ethylhexyl)phthalate, di-isodecyl phthalate, ethylene thiourea, methyl isobutyl ketone, methanol, toluene, lead and lead compounds which are known to the State of California to cause birth defects and other reproductive harm. For more information go to www.P65Warnings.ca.gov.

Parker Series 5-XXX O-Ring Sizes (Continued)

Std 5-Size	Inches				Metric 5-Size	Millimeters				Std 5-Size	Inches				Metric 5-Size	Millimeters			
	I.D.	Tol ±	W.	Tol ±		I.D.	Tol ±	W	Tol ±		I.D.	Tol ±	W.	Tol ±		I.D.	Tol ±	W	Tol ±
5-162	.554	.007	.070	.003	5-162	14.07	0.18	1.78	.08	5-004	1.070	.010	.065	.003	5-004	27.18	0.25	1.65	.08
5-239	.570	.007	.106	.004	5-239	14.48	0.18	2.69	.10	5-763	1.080	.010	.050	.003	5-763	27.43	0.25	1.27	.08
5-156	.575	.007	.060	.003	5-156	14.61	0.18	1.52	.08	5-600	1.094	.010	.141	.004	5-600	27.79	0.25	3.58	.10
5-563	.583	.007	.040	.003	5-563	14.81	0.18	1.02	.08	5-140	1.112	.010	.031	.003	5-140	28.24	0.25	0.79	.08
5-735	.583	.007	.103	.003	5-735	14.81	0.18	2.62	.08	5-601	1.153	.012	.141	.004	5-601	29.29	0.30	3.58	.10
5-736	.590	.007	.070	.003	5-736	14.99	0.18	1.78	.08	5-291	1.186	.012	.070	.003	5-291	30.12	0.30	1.78	.08
5-591	.594	.007	.106	.004	5-591	15.09	0.18	2.69	.10	5-1028	1.190	.012	.250	.006	5-1028	30.23	0.30	6.35	.15
5-609	.600	.007	.094	.003	5-609	15.24	0.18	2.39	.08	5-602	1.212	.012	.141	.004	5-602	30.78	0.30	3.58	.10
5-242	.600	.007	.105	.004	5-242	15.24	0.18	2.67	.10	5-294	1.213	.012	.149	.004	5-294	30.81	0.30	3.78	.10
5-021	.603	.007	.125	.004	5-021	15.32	0.18	3.18	.10	5-295	1.225	.012	.275	.006	5-295	31.12	0.30	6.99	.15
5-243	.604	.007	.103	.003	5-243	15.34	0.18	2.62	.08	5-141	1.226	.012	.031	.003	5-141	31.14	0.30	0.79	.08
5-676	.610	.007	.058	.003	5-676	15.49	0.18	1.47	.08	5-296	1.229	.012	.070	.003	5-296	31.22	0.30	1.78	.08
5-247	.623	.007	.125	.004	5-247	15.82	0.18	3.18	.10	5-297	1.230	.012	.197	.005	5-297	31.24	0.30	5.00	.13
5-248	.625	.007	.050	.003	5-248	15.88	0.18	1.27	.08	5-301	1.259	.012	.092	.003	5-301	31.98	0.30	2.34	.08
5-617	.625	.007	.103	.003	5-617	15.88	0.18	2.62	.08	5-603	1.279	.012	.141	.004	5-603	32.49	0.30	3.58	.10
5-250	.627	.007	.062	.003	5-250	15.93	0.18	1.57	.08	5-157	1.338	.012	.092	.003	5-157	33.99	0.30	2.34	.08
5-251	.631	.007	.062	.003	5-251	16.03	0.18	1.57	.08	5-604	1.342	.012	.141	.004	5-604	34.09	0.30	3.58	.10
5-005	.640	.007	.080	.003	5-005	16.26	0.18	2.03	.08	5-605	1.401	.014	.141	.004	5-605	35.59	0.36	3.58	.10
5-136	.643	.007	.031	.003	5-136	16.33	0.18	0.79	.08	5-780	1.412	.014	.073	.003	5-780	35.86	0.36	1.85	.08
5-643	.650	.007	.045	.003	5-643	16.51	0.18	1.14	.08	5-008	1.421	.014	.080	.003	5-008	36.09	0.36	2.03	.08
5-252	.652	.007	.070	.003	5-252	16.56	0.18	1.78	.08	5-670	1.437	.014	.070	.003	5-670	36.40	0.36	1.78	.08
5-254	.660	.007	.064	.003	5-254	16.76	0.18	1.63	.08	5-142	1.450	.014	.047	.003	5-142	36.83	0.36	1.19	.08
5-743	.660	.007	.141	.004	5-743	16.76	0.18	3.58	.10	5-312	1.454	.014	.105	.004	5-312	36.93	0.36	2.67	.10
5-592	.665	.007	.106	.004	5-592	16.89	0.18	2.69	.10	5-657	1.465	.014	.103	.003	5-657	37.21	0.36	2.62	.08
5-256	.707	.008	.103	.003	5-256	17.96	0.20	2.62	.08	5-606	1.468	.014	.141	.004	5-606	37.29	0.36	3.58	.10
5-594	.720	.008	.141	.004	5-594	18.29	0.20	3.58	.10	5-980	1.475	.014	.275	.006	5-980	37.47	0.36	6.99	.15
5-257	.722	.008	.113	.004	5-257	18.34	0.20	2.87	.10	5-024	1.515	.015	.125	.004	5-024	38.48	0.38	3.18	.10
5-593	.724	.008	.106	.004	5-593	18.39	0.20	2.69	.10	5-320	1.540	.015	.070	.003	5-320	39.12	0.38	1.78	.08
5-181	.725	.008	.040	.003	5-181	18.42	0.20	1.02	.08	5-158	1.550	.015	.092	.003	5-158	39.37	0.38	2.34	.08
5-964	.744	.008	.109	.004	5-964	18.90	0.20	2.77	.10	5-009	1.553	.015	.080	.003	5-009	39.45	0.38	2.03	.08
5-263	.750	.008	.061	.003	5-263	19.05	0.20	1.55	.08	5-321	1.559	.015	.139	.004	5-321	39.60	0.38	3.53	.10
5-264	.752	.008	.070	.003	5-264	19.10	0.20	1.78	.08	5-788	1.591	.015	.071	.003	5-788	40.41	0.38	1.80	.08
5-266	.766	.008	.080	.003	5-266	19.46	0.20	2.03	.08	5-327	1.640	.015	.139	.004	5-327	41.66	0.38	3.53	.10
5-137	.775	.008	.031	.003	5-137	19.69	0.20	0.79	.08	5-143	1.670	.015	.047	.003	5-143	42.42	0.38	1.19	.08
5-595	.779	.008	.141	.004	5-595	19.79	0.20	3.58	.10	5-329	1.670	.015	.070	.003	5-329	42.42	0.38	1.78	.08
5-006	.796	.008	.080	.003	5-006	20.22	0.20	2.03	.08	5-1018	1.671	.015	.139	.004	5-1018	42.44	0.38	3.53	.10
5-751	.820	.009	.150	.005	5-751	20.83	0.23	3.81	.13	5-330	1.674	.015	.210	.005	5-330	42.52	0.38	5.33	.13
5-003	.836	.009	.059	.003	5-003	21.23	0.23	1.50	.08	5-671	1.680	.015	.080	.003	5-671	42.67	0.38	2.03	.08
5-596	.838	.009	.141	.004	5-596	21.29	0.23	3.58	.10	5-025	1.765	.016	.125	.004	5-025	44.83	0.41	3.18	.10
5-708	.850	.009	.045	.003	5-708	21.59	0.23	1.14	.08	5-035	1.786	.016	.139	.004	5-035	45.36	0.41	3.53	.10
5-753	.857	.009	.123	.004	5-753	21.77	0.23	3.12	.10	5-1023	1.788	.016	.070	.003	5-1023	45.42	0.41	1.78	.08
5-049	.871	.009	.140	.004	5-049	22.12	0.23	3.56	.10	5-335	1.802	.016	.062	.003	5-335	45.77	0.41	1.57	.08
5-273	.879	.009	.040	.003	5-273	22.33	0.23	1.02	.08	5-794	1.812	.016	.070	.003	5-794	46.02	0.41	1.78	.08
5-022	.890	.009	.125	.004	5-022	22.61	0.23	3.18	.10	5-1042	1.817	.016	.257	.006	5-1042	46.15	0.41	6.53	.15
5-138	.898	.009	.031	.003	5-138	22.81	0.23	0.79	.08	5-795	1.850	.016	.070	.003	5-795	46.99	0.41	1.78	.08
5-597	.905	.009	.141	.004	5-597	22.99	0.23	3.58	.10	5-981	1.850	.016	.275	.006	5-981	46.99	0.41	6.99	.15
5-598	.968	.010	.141	.004	5-598	24.59	0.25	3.58	.10	5-011	1.860	.016	.080	.003	5-011	47.24	0.41	2.03	.08
5-278	.979	.010	.103	.003	5-278	24.87	0.25	2.62	.08	5-337	1.873	.016	.062	.003	5-337	47.57	0.41	1.57	.08
5-139	.987	.010	.031	.003	5-139	25.07	0.25	0.79	.08	5-1043	1.882	.017	.118	.004	5-1043	47.80	0.43	3.00	.10
5-709	1.000	.010	.055	.003	5-709	25.40	0.25	1.40	.08	5-144	1.891	.017	.047	.003	5-144	48.03	0.43	1.19	.08
5-677	1.004	.010	.081	.003	5-677	25.50	0.25	2.06	.08	5-796	1.913	.017	.070	.003	5-796	48.59	0.43	1.78	.08
5-279	1.004	.010	.218	.005	5-279	25.50	0.25	5.54	.13	5-338	1.925	.017	.210	.005	5-338	48.90	0.43	5.33	.13
5-761	1.010	.010	.062	.003	5-761	25.65	0.25	1.57	.08	5-701	1.937	.017	.139	.004	5-701	49.20	0.43	3.53	.10
5-618	1.016	.010	.139	.004	5-618	25.81	0.25	3.53	.10	5-342	1.980	.017	.038	.003	5-342	50.29	0.43	0.97	.08
5-599	1.031	.010	.141	.004	5-599	26.19	0.25	3.58	.10	5-343	2.000	.018	.075	.003	5-343	50.80	0.46	1.91	.08

(a) The rubber compound must be added when ordering by the 5-size number (i.e., N0674-70 5-007).

(b) This chart provides dimensions for standard (AN) shrinkage materials ONLY. These correspond to AS568A dimensions. O-rings manufactured out of compounds with different shrinkage rates (other than AN) will produce slightly different dimensions and tolerances. For more information on shrinkage rates, see the Appendix.

Table 9-3: Parker Series 5-XXX O-Rings Size Cross Reference Table

WARNING: These products can expose you to chemicals including carbon black (airborne and extracts), antimony trioxide, titanium dioxide, silica (crystalline), di(2-ethylhexyl) phthalate, ethylene thiourea, acrylonitrile, 1,3-butadiene, epichlorohydrin, toluenediisocyanate, tetrafluoroethylene, ethylbenzene, formaldehyde, furfuryl alcohol, glass fibers, methyl isobutyl ketone, nickel (metallic and compounds), lead and lead compounds which are known to the State of California to cause cancer; and 1,3-butadiene, epichlorohydrin, di(2-ethylhexyl)phthalate, di-isodecyl phthalate, ethylene thiourea, methyl isobutyl ketone, methanol, toluene, lead and lead compounds which are known to the State of California to cause birth defects and other reproductive harm. For more information go to www.P65Warnings.ca.gov.

Parker Series 5-XXX O-Ring Sizes (Continued)

Std 5-Size	Inches				Metric 5-Size	Millimeters				Std 5-Size	Inches				Metric 5-Size	Millimeters			
	I.D.	Tol ±	W.	Tol ±		I.D.	Tol ±	W	Tol ±		I.D.	Tol ±	W.	Tol ±		I.D.	Tol ±	W	Tol ±
5-655	2.020	.018	.070	.003	5-655	51.31	0.46	1.78	.08	5-031	3.640	.028	.125	.004	5-031	92.46	0.71	3.18	.10
5-037	2.036	.018	.139	.004	5-037	51.71	0.46	3.53	.10	5-828	3.661	.028	.090	.003	5-828	92.99	0.71	2.29	.08
5-346	2.046	.018	.139	.004	5-346	51.97	0.46	3.53	.10	5-986	3.725	.028	.275	.006	5-986	94.62	0.71	6.99	.15
5-642	2.051	.018	.070	.003	5-642	52.10	0.46	1.78	.08	5-390	3.957	.028	.147	.004	5-390	100.51	0.71	3.73	.10
5-1044	2.060	.018	.139	.004	5-1044	52.32	0.46	3.53	.10	5-987	3.975	.028	.275	.006	5-987	100.97	0.71	6.99	.15
5-027	2.140	.018	.125	.004	5-027	54.36	0.46	3.18	.10	5-831	4.020	.030	.147	.004	5-831	102.11	0.76	3.73	.10
5-1046	2.140	.018	.315	.010	5-1046	54.36	0.46	8.00	.25	5-1054	4.080	.030	.209	.005	5-1054	103.63	0.76	5.31	.13
5-145	2.141	.018	.047	.003	5-145	54.38	0.46	1.19	.08	5-833	4.085	.030	.103	.003	5-833	103.76	0.76	2.62	.08
5-347	2.163	.018	.062	.003	5-347	54.94	0.46	1.57	.08	5-394	4.096	.030	.070	.003	5-394	104.04	0.76	1.78	.08
5-348	2.172	.018	.070	.003	5-348	55.17	0.46	1.78	.08	5-988	4.100	.030	.275	.006	5-988	104.14	0.76	6.99	.15
5-800	2.225	.018	.275	.006	5-800	56.52	0.46	6.99	.15	5-395	4.117	.030	.070	.003	5-395	104.57	0.76	1.78	.08
5-1047	2.281	.020	.093	.003	5-1047	57.94	0.51	2.36	.08	5-396	4.171	.030	.070	.003	5-396	105.94	0.76	1.78	.08
5-015	2.296	.020	.080	.003	5-015	58.32	0.51	2.03	.08	5-989	4.225	.030	.275	.006	5-989	107.32	0.76	6.99	.15
5-702	2.312	.020	.139	.004	5-702	58.72	0.51	3.53	.10	5-060	4.390	.030	.044	.003	5-060	111.51	0.76	1.12	.08
5-039	2.411	.020	.139	.004	5-039	61.24	0.51	3.53	.10	5-836	4.427	.030	.140	.004	5-836	112.45	0.76	3.56	.10
5-354	2.471	.020	.070	.003	5-354	62.76	0.51	1.78	.08	5-401	4.531	.030	.070	.003	5-401	115.09	0.76	1.78	.08
5-355	2.524	.020	.103	.003	5-355	64.11	0.51	2.62	.08	5-1060	4.609	.033	.150	.004	5-1060	117.07	0.84	3.81	.10
5-805	2.535	.020	.070	.003	5-805	64.39	0.51	1.78	.08	5-840	4.630	.033	.139	.004	5-840	117.60	0.84	3.53	.10
5-703	2.563	.020	.139	.004	5-703	65.10	0.51	3.53	.10	5-842	4.664	.035	.122	.004	5-842	118.47	0.89	3.10	.10
5-358	2.576	.020	.082	.003	5-358	65.43	0.51	2.08	.08	5-844	4.682	.035	.140	.004	5-844	118.92	0.89	3.56	.10
5-361	2.671	.022	.139	.004	5-361	67.84	0.56	3.53	.10	5-402	4.750	.035	.188	.005	5-402	120.65	0.89	4.78	.13
5-159	2.683	.022	.115	.004	5-159	68.15	0.56	2.92	.10	5-848	4.875	.035	.060	.003	5-848	123.83	0.89	1.52	.08
5-982	2.725	.022	.275	.006	5-982	69.22	0.56	6.99	.15	5-850	4.925	.035	.260	.006	5-850	125.10	0.89	6.60	.15
5-807	2.782	.022	.103	.003	5-807	70.66	0.56	2.62	.08	5-403	4.930	.035	.103	.003	5-403	125.22	0.89	2.62	.08
5-704	2.812	.022	.139	.004	5-704	71.42	0.56	3.53	.10	5-851	4.984	.035	.147	.004	5-851	126.59	0.89	3.73	.10
5-042	2.846	.022	.139	.004	5-042	72.29	0.56	3.53	.10	5-852	5.030	.035	.210	.005	5-852	127.76	0.89	5.33	.13
5-697	2.878	.022	.080	.003	5-697	73.10	0.56	2.03	.08	5-853	5.057	.035	.233	.006	5-853	128.45	0.89	5.92	.15
5-367	2.924	.022	.103	.003	5-367	74.27	0.56	2.62	.08	5-559	5.236	.035	.214	.005	5-559	133.00	0.89	5.44	.13
5-705	2.937	.022	.139	.004	5-705	74.60	0.56	3.53	.10	5-407	5.249	.035	.123	.004	5-407	133.32	0.89	3.12	.10
5-368	3.020	.024	.103	.003	5-368	76.71	0.61	2.62	.08	5-408	5.265	.035	.139	.004	5-408	133.73	0.89	3.53	.10
5-044	3.036	.024	.139	.004	5-044	77.11	0.61	3.53	.10	5-410	5.340	.035	.070	.003	5-410	135.64	0.89	1.78	.08
5-369	3.037	.024	.103	.003	5-369	77.14	0.61	2.62	.08	5-412	5.414	.035	.103	.003	5-412	137.52	0.89	2.62	.08
5-810	3.041	.024	.062	.003	5-810	77.24	0.61	1.57	.08	5-855	5.444	.035	.124	.004	5-855	138.28	0.89	3.15	.10
5-811	3.060	.024	.112	.004	5-811	77.72	0.61	2.84	.10	5-856	5.465	.035	.070	.003	5-856	138.81	0.89	1.78	.08
5-1052	3.080	.024	.111	.004	5-1052	78.23	0.61	2.82	.10	5-413	5.475	.035	.164	.005	5-413	139.07	0.89	4.17	.13
5-374	3.112	.024	.070	.003	5-374	79.04	0.61	1.78	.08	5-414	5.487	.035	.062	.003	5-414	139.37	0.89	1.57	.08
5-557	3.125	.024	.103	.003	5-557	79.38	0.61	2.62	.08	5-858	5.500	.035	.168	.005	5-858	139.70	0.89	4.27	.13
5-813	3.130	.024	.100	.003	5-813	79.50	0.61	2.54	.08	5-416	5.553	.035	.120	.004	5-416	141.05	0.89	3.05	.10
5-815	3.156	.024	.060	.003	5-815	80.16	0.61	1.52	.08	5-062	5.604	.040	.070	.003	5-062	142.34	1.02	1.78	.08
5-045	3.161	.024	.139	.004	5-045	80.29	0.61	3.53	.10	5-417	5.616	.040	.127	.004	5-417	142.65	1.02	3.23	.10
5-816	3.162	.024	.070	.003	5-816	80.31	0.61	1.78	.08	5-063	5.750	.040	.070	.003	5-063	146.05	1.02	1.78	.08
5-819	3.210	.024	.103	.003	5-819	81.53	0.61	2.62	.08	5-862	5.789	.040	.252	.006	5-862	147.04	1.02	6.40	.15
5-984	3.225	.024	.275	.006	5-984	81.92	0.61	6.99	.15	5-863	5.815	.040	.140	.004	5-863	147.70	1.02	3.56	.10
5-821	3.300	.026	.070	.003	5-821	83.82	0.66	1.78	.08	5-421	5.882	.040	.110	.004	5-421	149.40	1.02	2.79	.10
5-825	3.350	.026	.275	.006	5-825	85.09	0.66	6.99	.15	5-573	5.968	.040	.070	.003	5-573	151.59	1.02	1.78	.08
5-1053	3.354	.026	.070	.003	5-1053	85.19	0.66	1.78	.08	5-567	5.985	.040	.070	.003	5-567	152.02	1.02	1.78	.08
5-380	3.363	.026	.155	.005	5-380	85.42	0.66	3.94	.13	5-1041	6.023	.040	.103	.003	5-1041	152.98	1.02	2.62	.08
5-979	3.443	.026	.275	.006	5-979	87.45	0.66	6.99	.15	5-064	6.350	.040	.275	.006	5-064	161.29	1.02	6.99	.15
5-381	3.475	.026	.275	.006	5-381	88.27	0.66	6.99	.15	5-428	6.361	.040	.108	.004	5-428	161.57	1.02	2.74	.10
5-985	3.600	.026	.275	.006	5-985	91.44	0.66	6.99	.15	5-430	6.482	.040	.170	.005	5-430	164.64	1.02	4.32	.13

(a) The rubber compound must be added when ordering by the 5-size number (i.e., N0674-70 5-007).

(b) This chart provides dimensions for standard (AN) shrinkage materials ONLY. These correspond to AS568A dimensions. O-rings manufactured out of compounds with different shrinkage rates (other than AN) will produce slightly different dimensions and tolerances. For more information on shrinkage rates, see the Appendix.

Table 9-3: Parker Series 5-XXX O-Rings Size Cross Reference Table



WARNING: These products can expose you to chemicals including carbon black (airborne and extracts), antimony trioxide, titanium dioxide, silica (crystalline), di(2-ethylhexyl) phthalate, ethylene thiourea, acrylonitrile, 1,3-butadiene, epichlorohydrin, toluenediisocyanate, tetrafluoroethylene, ethylbenzene, formaldehyde, furfuryl alcohol, glass fibers, methyl isobutyl ketone, nickel (metallic and compounds), lead and lead compounds which are known to the State of California to cause cancer; and 1,3-butadiene, epichlorohydrin, di(2-ethylhexyl)phthalate, di-isodecyl phthalate, ethylene thiourea, methyl isobutyl ketone, methanol, toluene, lead and lead compounds which are known to the State of California to cause birth defects and other reproductive harm. For more information go to www.P65Warnings.ca.gov.

Parker Series 5-XXX O-Ring Sizes (Continued)

Std 5-Size	Inches				Metric 5-Size	Millimeters				Std 5-Size	Inches				Metric 5-Size	Millimeters			
	I.D.	Tol ±	W.	Tol ±		I.D.	Tol ±	W	Tol ±		I.D.	Tol ±	W.	Tol ±		I.D.	Tol ±	W	Tol ±
5-666	6.520	.040	.070	.003	5-666	165.61	1.02	1.78	.08	5-569	12.475	.070	.139	.004	5-569	316.87	1.78	3.53	.10
5-869	6.609	.045	.139	.004	5-869	167.87	1.14	3.53	.10	5-905	12.623	.070	.140	.004	5-905	320.62	1.78	3.56	.10
5-434	7.108	.045	.275	.006	5-434	180.54	1.14	6.99	.15	5-906	12.705	.070	.070	.003	5-906	322.71	1.78	1.78	.08
5-696	7.110	.045	.103	.003	5-696	180.59	1.14	2.62	.08	5-907	12.725	.070	.275	.006	5-907	323.22	1.78	6.99	.15
5-691	7.139	.045	.072	.003	5-691	181.33	1.14	1.83	.08	5-908	12.840	.070	.139	.004	5-908	326.14	1.78	3.53	.10
5-873	7.230	.045	.070	.003	5-873	183.64	1.14	1.78	.08	5-611	12.900	.070	.159	.005	5-611	327.66	1.78	4.04	.13
5-975	7.425	.045	.260	.006	5-975	188.60	1.14	6.60	.15	5-619	12.915	.070	.139	.004	5-619	328.04	1.78	3.53	.10
5-875	7.580	.050	.210	.005	5-875	192.53	1.27	5.33	.13	5-492	13.248	.070	.139	.004	5-492	336.50	1.78	3.53	.10
5-438	7.613	.050	.070	.003	5-438	193.37	1.27	1.78	.08	5-070	13.270	.070	.139	.004	5-070	337.06	1.78	3.53	.10
5-439	7.640	.050	.125	.004	5-439	194.06	1.27	3.18	.10	5-910	13.375	.070	.210	.005	5-910	339.73	1.78	5.33	.13
5-876	7.674	.050	.210	.005	5-876	194.92	1.27	5.33	.13	5-071	13.410	.070	.139	.004	5-071	340.61	1.78	3.53	.10
5-877	7.802	.050	.104	.003	5-877	198.17	1.27	2.64	.08	5-072	13.460	.070	.210	.005	5-072	341.88	1.78	5.33	.13
5-445	8.277	.050	.275	.006	5-445	210.24	1.27	6.99	.15	5-493	13.490	.070	.139	.004	5-493	342.65	1.78	3.53	.10
5-880	8.350	.050	.275	.006	5-880	212.09	1.27	6.99	.15	5-494	13.541	.070	.210	.005	5-494	343.94	1.78	5.33	.13
5-575	8.875	.055	.070	.003	5-575	225.42	1.40	1.78	.08	5-496	13.616	.070	.141	.004	5-496	345.85	1.78	3.58	.10
5-450	9.071	.055	.062	.003	5-450	230.40	1.40	1.57	.08	5-498	13.650	.070	.139	.004	5-498	346.71	1.78	3.53	.10
5-882	9.162	.055	.210	.005	5-882	232.72	1.40	5.33	.13	5-500	13.718	.070	.275	.006	5-500	348.44	1.78	6.48	.15
5-635	9.370	.055	.103	.003	5-635	238.00	1.40	2.62	.08	5-912	13.734	.070	.139	.004	5-912	348.84	1.78	3.53	.10
5-883	9.820	.060	.103	.003	5-883	249.43	1.52	2.62	.08	5-1097	13.750	.070	.103	.003	5-1097	349.25	1.78	2.62	.08
5-884	9.984	.060	.070	.003	5-884	253.59	1.52	1.78	.08	5-073	13.820	.080	.139	.004	5-073	351.03	2.03	3.53	.10
5-885	10.171	.060	.139	.004	5-885	258.34	1.52	3.53	.10	5-502	14.088	.080	.210	.005	5-502	357.84	2.03	5.33	.13
5-886	10.178	.060	.112	.004	5-886	258.52	1.52	2.84	.10	5-624	14.111	.080	.139	.004	5-624	358.42	2.03	3.53	.10
5-457	10.232	.060	.139	.004	5-457	259.89	1.52	3.53	.10	5-074	14.234	.080	.139	.004	5-074	361.54	2.03	3.53	.10
5-458	10.340	.060	.139	.004	5-458	262.64	1.52	3.53	.10	5-504	14.430	.080	.139	.004	5-504	366.52	2.03	3.53	.10
5-887	10.343	.060	.275	.006	5-887	262.71	1.52	6.99	.15	5-626	14.470	.080	.087	.003	5-626	367.54	2.03	2.21	.08
5-165	10.359	.060	.139	.004	5-165	263.12	1.52	3.53	.10	5-505	14.470	.080	.139	.004	5-505	367.54	2.03	3.53	.10
5-889	10.372	.060	.104	.003	5-889	263.45	1.52	2.64	.08	5-506	14.570	.080	.141	.004	5-506	370.08	2.03	3.58	.10
5-976	10.425	.060	.260	.006	5-976	264.80	1.52	6.60	.15	5-507	14.600	.080	.210	.005	5-507	370.84	2.03	5.33	.13
5-890	10.606	.060	.103	.003	5-890	269.39	1.52	2.62	.08	5-508	14.674	.080	.139	.004	5-508	372.72	2.03	3.53	.10
5-623	10.630	.060	.139	.004	5-623	270.00	1.52	3.53	.10	5-166	14.722	.080	.139	.004	5-166	373.94	2.03	3.53	.10
5-464	10.656	.060	.070	.003	5-464	270.66	1.52	1.78	.08	5-920	14.780	.080	.175	.005	5-920	375.41	2.03	4.45	.13
5-891	10.734	.060	.139	.004	5-891	272.64	1.52	3.53	.10	5-921	14.795	.080	.171	.003	5-921	375.79	2.03	1.80	.08
5-466	10.749	.060	.210	.005	5-466	273.03	1.52	5.33	.10	5-512	15.171	.080	.139	.004	5-512	385.34	2.03	3.53	.10
5-469	10.883	.060	.103	.003	5-469	276.43	1.52	2.62	.08	5-076	15.260	.080	.210	.005	5-076	387.60	2.03	5.33	.13
5-471	10.995	.060	.149	.004	5-471	279.27	1.52	3.78	.10	5-077	15.300	.080	.139	.004	5-077	388.62	2.03	3.53	.10
5-894	10.996	.060	.103	.003	5-894	279.30	1.52	2.62	.10	5-924	15.410	.080	.210	.005	5-924	391.41	2.03	5.33	.13
5-474	11.331	.060	.275	.006	5-474	287.81	1.52	6.99	.15	5-925	15.465	.080	.188	.005	5-925	392.81	2.03	4.78	.13
5-898	11.335	.060	.103	.003	5-898	287.91	1.52	2.62	.08	5-079	15.540	.080	.139	.004	5-079	394.72	2.03	3.53	.10
5-476	11.562	.070	.275	.006	5-476	293.67	1.78	6.99	.15	5-515	15.548	.080	.210	.005	5-515	394.92	2.03	5.33	.13
5-069	11.750	.070	.139	.004	5-069	298.45	1.78	3.53	.10	5-516	15.740	.080	.139	.004	5-516	399.80	2.03	3.53	.10
5-900	12.000	.070	.187	.005	5-900	304.80	1.78	4.75	.13	5-517	15.750	.080	.275	.006	5-517	400.05	2.03	6.99	.15
5-480	12.017	.070	.285	.006	5-480	305.23	1.78	7.24	.15	5-518	16.031	.080	.256	.006	5-518	407.19	2.03	6.50	.15
5-482	12.109	.070	.139	.004	5-482	307.57	1.78	3.53	.10	5-571	16.234	.090	.139	.004	5-571	412.34	2.29	3.53	.10
5-164	12.160	.070	.210	.005	5-164	308.86	1.78	5.33	.13	5-930	16.285	.090	.250	.006	5-930	413.64	2.29	6.35	.15
5-901	12.234	.070	.139	.004	5-901	310.74	1.78	3.53	.10	5-520	16.435	.090	.139	.004	5-520	417.45	2.29	3.53	.10
5-485	12.260	.070	.139	.004	5-485	311.40	1.78	3.53	.10	5-522	16.507	.090	.225	.006	5-522	419.28	2.29	5.72	.15
5-486	12.299	.070	.137	.004	5-486	312.39	1.78	3.48	.10	5-080	16.575	.090	.187	.005	5-080	421.01	2.29	4.75	.13
5-902	12.360	.070	.210	.005	5-902	313.94	1.78	5.33	.13	5-524	16.640	.090	.210	.005	5-524	422.66	2.29	5.33	.13
5-487	12.380	.070	.139	.004	5-487	314.45	1.78	3.53	.10	5-622	16.750	.090	.275	.006	5-622	425.45	2.29	6.99	.15
5-488	12.463	.070	.103	.003	5-488	316.56	1.78	2.62	.08	5-525	16.765	.090	.125	.004	5-525	425.83	2.29	3.18	.10

(a) The rubber compound must be added when ordering by the 5-size number (i.e., N0674-70 5-007).

(b) This chart provides dimensions for standard (AN) shrinkage materials ONLY. These correspond to AS568A dimensions. O-rings manufactured out of compounds with different shrinkage rates (other than AN) will produce slightly different dimensions and tolerances. For more information on shrinkage rates, see the Appendix.

Table 9-3: Parker Series 5-XXX O-Rings Size Cross Reference Table

WARNING: These products can expose you to chemicals including carbon black (airborne and extracts), antimony trioxide, titanium dioxide, silica (crystalline), di(2-ethylhexyl) phthalate, ethylene thiourea, acrylonitrile, 1,3-butadiene, epichlorohydrin, toluenediisocyanate, tetrafluoroethylene, ethylbenzene, formaldehyde, furfuryl alcohol, glass fibers, methyl isobutyl ketone, nickel (metallic and compounds), lead and lead compounds which are known to the State of California to cause cancer; and 1,3-butadiene, epichlorohydrin, di(2-ethylhexyl)phthalate, di-isodecyl phthalate, ethylene thiourea, methyl isobutyl ketone, methanol, toluene, lead and lead compounds which are known to the State of California to cause birth defects and other reproductive harm. For more information go to www.P65Warnings.ca.gov.

Parker Series 5-XXX O-Ring Sizes (Continued)

Std 5-Size	Inches				Metric 5-Size	Millimeters				Std 5-Size	Inches				Metric 5-Size	Millimeters			
	I.D.	Tol ±	W.	Tol ±		I.D.	Tol ±	W	Tol ±		I.D.	Tol ±	W.	Tol ±		I.D.	Tol ±	W	Tol ±
5-935	17.100	.090	.275	.006	5-935	434.34	2.29	6.99	.15	5-088	21.180	.100	.147	.004	5-088	537.97	2.54	3.73	.10
5-526	17.250	.090	.187	.005	5-526	438.15	2.29	4.75	.13	5-547	21.564	.100	.139	.004	5-547	547.73	2.54	3.53	.10
5-082	17.250	.090	.240	.006	5-082	438.15	2.29	6.10	.15	5-953	22.360	.100	.132	.004	5-953	567.94	2.54	3.35	.10
5-528	17.268	.090	.242	.006	5-528	438.61	2.29	6.15	.15	5-089	23.406	.120	.281	.006	5-089	594.51	3.05	7.14	.15
5-937	17.390	.090	.139	.004	5-937	441.71	2.29	3.53	.10	5-551	23.540	.120	.139	.004	5-551	597.92	3.05	3.53	.10
5-529	17.455	.090	.139	.004	5-529	443.36	2.29	3.53	.10	5-090	23.576	.120	.139	.004	5-090	598.83	3.05	3.53	.10
5-1100	17.500	.090	.139	.004	5-1100	444.50	2.29	3.53	.10	5-552	23.612	.120	.275	.006	5-552	599.74	3.05	6.99	.15
5-939	17.870	.090	.210	.005	5-939	453.90	2.29	5.33	.13	5-167	23.780	.120	.375	.007	5-167	604.01	3.05	9.52	.18
5-083	17.910	.090	.139	.004	5-083	454.91	2.29	3.53	.10	5-168	24.875	.120	.250	.006	5-168	631.82	3.05	6.35	.15
5-084	18.062	.090	.281	.006	5-084	458.77	2.29	7.16	.15	5-169	25.153	.120	.214	.005	5-169	638.89	3.05	5.44	.13
5-533	18.169	.090	.096	.003	5-533	461.49	2.29	2.44	.08	5-091	25.474	.120	.139	.004	5-091	647.04	3.05	3.53	.10
5-1102	18.265	.090	.210	.005	5-1102	463.93	2.29	5.33	.13	5-170	25.500	.120	.275	.006	5-170	647.70	3.05	6.99	.15
5-085	18.350	.090	.210	.005	5-085	466.09	2.29	5.33	.13	5-171	26.125	.120	.275	.006	5-171	663.58	3.05	6.99	.15
5-534	18.405	.090	.210	.005	5-534	467.49	2.29	5.33	.13	5-173	26.188	.120	.210	.005	5-173	665.18	3.05	5.33	.13
5-1104	18.500	.090	.188	.005	5-1104	469.90	2.29	4.78	.13	5-631	26.408	.120	.139	.004	5-631	670.76	3.05	3.53	.10
5-1105	18.635	.090	.139	.004	5-1105	473.33	2.29	3.53	.10	5-172	27.485	.120	.275	.006	5-172	698.12	3.05	6.99	.15
5-943	18.870	.100	.275	.006	5-943	479.30	2.54	6.99	.15	5-092	27.625	.120	.275	.006	5-092	701.68	3.05	6.99	.15
5-944	18.880	.100	.139	.004	5-944	479.55	2.54	3.53	.10	5-955	28.801	.140	.275	.006	5-955	731.55	3.56	6.99	.15
5-947	19.380	.100	.139	.004	5-947	492.25	2.54	3.53	.10										
5-541	19.500	.100	.250	.006	5-541	495.30	2.54	6.35	.15										
5-086	19.580	.100	.210	.005	5-086	497.33	2.54	5.33	.13										
5-948	19.725	.100	.210	.005	5-948	501.02	2.54	5.33	.13										
5-950	19.960	.100	.139	.004	5-950	506.98	2.54	3.53	.10										
5-1010	20.609	.100	.139	.004	5-1010	523.47	2.54	3.53	.10										

- (a) The rubber compound must be added when ordering by the 5-size number (i.e., N0674-70 5-007).
- (b) This chart provides dimensions for standard (AN) shrinkage materials ONLY. These correspond to AS568A dimensions. O-rings manufactured out of compounds with different shrinkage rates (other than AN) will produce slightly different dimensions and tolerances. For more information on shrinkage rates, see the Appendix.

Table 9-3: Parker Series 5-XXX O-Rings Size Cross Reference Table

WARNING: These products can expose you to chemicals including carbon black (airborne and extracts), antimony trioxide, titanium dioxide, silica (crystalline), di(2-ethylhexyl) phthalate, ethylene thiourea, acrylonitrile, 1,3-butadiene, epichlorohydrin, toluenediisocyanate, tetrafluoroethylene, ethylbenzene, formaldehyde, furfuryl alcohol, glass fibers, methyl isobutyl ketone, nickel (metallic and compounds), lead and lead compounds which are known to the State of California to cause cancer; and 1,3-butadiene, epichlorohydrin, di(2-ethylhexyl)phthalate, di-isodecyl phthalate, ethylene thiourea, methyl isobutyl ketone, methanol, toluene, lead and lead compounds which are known to the State of California to cause birth defects and other reproductive harm. For more information go to www.P65Warnings.ca.gov.

Series 5-XXX Locator Table

Size	I.D.	Size	I.D.	Size	I.D.	Size	I.D.	Size	I.D.
5-001	.547	5-118	.059	5-243	.604	5-421	5.882	5-578	.102
5-002	.416	5-124	.176	5-247	.623	5-428	6.361	5-579	.133
5-003	.836	5-125	.180	5-248	.625	5-430	6.482	5-580	.165
5-004	1.070	5-127	.239	5-250	.627	5-434	7.108	5-581	.192
5-005	.640	5-133	.332	5-251	.631	5-438	7.613	5-582	.224
5-006	.796	5-134	.410	5-252	.652	5-439	7.640	5-583	.251
5-008	1.421	5-135	.526	5-254	.660	5-445	8.277	5-584	.283
5-009	1.553	5-136	.643	5-256	.707	5-450	9.071	5-585	.314
5-011	1.860	5-137	.775	5-257	.772	5-457	10.232	5-586	.350
5-015	2.296	5-138	.898	5-263	.750	5-458	10.340	5-587	.350
5-018	.352	5-139	.987	5-264	.752	5-464	10.656	5-588	.413
5-021	.603	5-140	1.112	5-266	.766	5-466	10.749	5-590	.535
5-022	.890	5-141	1.226	5-273	.879	5-469	10.883	5-591	.594
5-024	1.515	5-142	1.450	5-278	.979	5-471	10.995	5-592	.665
5-025	1.765	5-143	1.670	5-279	1.004	5-474	11.331	5-593	.724
5-027	2.140	5-144	1.891	5-291	1.186	5-480	12.017	5-594	.720
5-031	3.640	5-145	2.141	5-294	1.213	5-482	12.109	5-595	.779
5-035	1.786	5-148	.154	5-295	1.225	5-485	12.260	5-596	.838
5-037	2.036	5-151	.239	5-296	1.229	5-486	12.299	5-597	.905
5-039	2.411	5-156	.575	5-297	1.230	5-487	12.380	5-598	.968
5-042	2.846	5-157	1.338	5-301	1.259	5-488	12.463	5-599	1.031
5-044	3.036	5-158	1.550	5-312	1.454	5-492	13.248	5-600	1.094
5-045	3.161	5-159	2.683	5-320	1.540	5-493	13.490	5-601	1.153
5-049	.871	5-160	.312	5-321	1.559	5-494	13.541	5-602	1.212
5-051	.070	5-162	.554	5-327	1.640	5-496	13.616	5-603	1.279
5-052	.270	5-164	12.160	5-329	1.670	5-498	13.650	5-604	1.342
5-056	.301	5-165	10.359	5-330	1.674	5-500	13.718	5-605	1.401
5-057	.364	5-166	14.722	5-335	1.802	5-502	14.088	5-606	1.468
5-058	.426	5-167	23.780	5-337	1.873	5-504	14.430	5-609	.600
5-060	4.390	5-168	24.875	5-338	1.925	5-505	14.470	5-611	12.900
5-062	5.604	5-169	25.153	5-342	1.980	5-506	14.570	5-612	.344
5-063	5.750	5-170	25.500	5-343	2.000	5-507	14.600	5-613	.437
5-064	6.350	5-171	26.125	5-346	2.046	5-508	14.674	5-614	.391
5-069	11.750	5-172	27.485	5-347	2.163	5-512	15.171	5-615	.469
5-070	13.270	5-173	26.188	5-348	2.172	5-515	15.548	5-616	.516
5-071	13.410	5-178	.120	5-354	2.471	5-516	15.740	5-617	.625
5-072	13.460	5-179	.239	5-355	2.524	5-517	15.750	5-618	1.016
5-073	13.820	5-180	.248	5-358	2.576	5-518	16.031	5-619	12.915
5-074	14.234	5-181	.725	5-361	2.671	5-520	16.435	5-622	16.750
5-076	15.260	5-187	.070	5-367	2.924	5-522	16.507	5-623	10.630
5-077	15.300	5-190	.132	5-368	3.020	5-524	16.640	5-624	14.111
5-079	15.540	5-193	.176	5-369	3.037	5-525	16.765	5-626	14.470
5-080	16.575	5-194	.228	5-374	3.112	5-526	17.250	5-631	26.408
5-082	17.250	5-197	.242	5-380	3.363	5-528	17.268	5-632	.110
5-083	17.910	5-202	.278	5-381	3.475	5-529	17.455	5-635	9.370
5-084	18.062	5-204	.312	5-390	3.957	5-533	18.169	5-638	.233
5-085	18.350	5-205	.312	5-394	4.096	5-534	18.405	5-642	2.051
5-086	19.580	5-206	.326	5-395	4.117	5-541	19.500	5-643	.650
5-088	21.180	5-209	.370	5-396	4.171	5-547	21.564	5-646	.126
5-089	23.406	5-211	.375	5-401	4.531	5-551	23.540	5-652	.473
5-090	23.576	5-212	.384	5-402	4.750	5-552	23.612	5-655	2.020
5-091	25.474	5-215	.418	5-403	4.930	5-557	3.125	5-657	1.465
5-092	27.625	5-218	.425	5-407	5.249	5-559	5.236	5-664	.320
5-101	.100	5-222	.455	5-408	5.265	5-563	.583	5-666	6.520
5-102	.116	5-223	.458	5-410	5.340	5-566	.489	5-669	.146
5-103	.128	5-225	.469	5-412	5.414	5-567	5.985	5-670	1.437
5-105	.154	5-230	.500	5-413	5.475	5-569	12.475	5-671	1.680
5-106	.154	5-231	.501	5-414	5.487	5-571	16.234	5-673	.305
5-107	.176	5-239	.570	5-416	5.553	5-573	5.968	5-675	.508
5-108	.176	5-242	.600	5-417	5.616	5-575	8.875	5-676	.610

Table 9-4: Series 5-XXX Locator Table

WARNING: These products can expose you to chemicals including carbon black (airborne and extracts), antimony trioxide, titanium dioxide, silica (crystalline), di(2-ethylhexyl) phthalate, ethylene thiourea, acrylonitrile, 1,3-butadiene, epichlorohydrin, toluenediisocyanate, tetrafluoroethylene, ethylbenzene, formaldehyde, furfuryl alcohol, glass fibers, methyl isobutyl ketone, nickel (metallic and compounds), lead and lead compounds which are known to the State of California to cause cancer; and 1,3-butadiene, epichlorohydrin, di(2-ethylhexyl)phthalate, di-isodecyl phthalate, ethylene thiourea, methyl isobutyl ketone, methanol, toluene, lead and lead compounds which are known to the State of California to cause birth defects and other reproductive harm. For more information go to www.P65Warnings.ca.gov.

Sizes

Series 5-XXX Locator Table (Continued)

Size	I.D.	Size	I.D.	Size	I.D.	Size	I.D.	Size	I.D.
5-677	1.004	5-763	1.080	5-855	5.444	5-912	13.734	5-989	4.225
5-682	.426	5-769	1.176	5-856	5.465	5-920	14.780	5-1002	.239
5-683	.122	5-780	1.412	5-858	5.500	5-921	14.795	5-1004	.290
5-685	.208	5-788	1.591	5-862	5.789	5-922	14.990	5-1006	.322
5-686	.248	5-794	1.812	5-863	5.815	5-924	15.410	5-1007	.330
5-687	.287	5-795	1.850	5-869	6.609	5-925	15.465	5-1010	20.609
5-691	7.139	5-796	1.913	5-873	7.230	5-930	16.285	5-1011	.447
5-696	7.110	5-800	2.225	5-875	7.580	5-935	17.100	5-1014	.525
5-697	2.878	5-805	2.535	5-876	7.674	5-937	17.390	5-1018	1.671
5-698	.283	5-807	2.782	5-877	7.802	5-939	17.870	5-1023	1.788
5-699	.353	5-810	3.041	5-880	8.350	5-943	18.870	5-1028	1.190
5-700	.354	5-811	3.060	5-882	9.162	5-944	18.880	5-1041	6.023
5-701	1.937	5-813	3.130	5-883	9.820	5-947	19.380	5-1042	1.817
5-702	2.312	5-815	3.156	5-884	9.984	5-948	19.725	5-1043	1.882
5-703	2.563	5-816	3.162	5-885	10.171	5-950	19.960	5-1044	2.060
5-704	2.812	5-819	3.210	5-886	10.178	5-953	22.360	5-1046	2.140
5-705	2.937	5-821	3.300	5-887	10.343	5-955	28.801	5-1047	2.281
5-708	.850	5-825	3.350	5-889	10.372	5-964	.744	5-1052	3.080
5-709	1.000	5-828	3.661	5-890	10.606	5-975	7.425	5-1053	3.354
5-710	.301	5-831	4.020	5-891	10.734	5-976	10.425	5-1054	4.080
5-712	.313	5-833	4.085	5-894	10.996	5-979	3.443	5-1060	4.609
5-716	.362	5-836	4.427	5-898	11.335	5-980	1.475	5-1097	13.750
5-718	.395	5-840	4.630	5-900	12.000	5-981	1.850	5-1100	17.500
5-726	.484	5-842	4.664	5-901	12.234	5-982	2.725	5-1102	18.265
5-735	.583	5-844	4.682	5-902	12.360	5-983	2.975	5-1104	18.500
5-736	.590	5-848	4.875	5-905	12.623	5-984	3.225	5-1105	18.635
5-743	.660	5-850	4.925	5-906	12.705	5-985	3.600		
5-751	.820	5-851	4.984	5-907	12.725	5-986	3.725		
5-753	.857	5-852	5.030	5-908	12.840	5-987	3.975		
5-761	1.010	5-853	5.057	5-910	13.375	5-988	4.100		

Table 9-4: Series 5-XXX Locator Table



WARNING: These products can expose you to chemicals including carbon black (airborne and extracts), antimony trioxide, titanium dioxide, silica (crystalline), di(2-ethylhexyl) phthalate, ethylene thiourea, acrylonitrile, 1,3-butadiene, epichlorohydrin, toluenediisocyanate, tetrafluoroethylene, ethylbenzene, formaldehyde, furfuryl alcohol, glass fibers, methyl isobutyl ketone, nickel (metallic and compounds), lead and lead compounds which are known to the State of California to cause cancer; and 1,3-butadiene, epichlorohydrin, di(2-ethylhexyl)phthalate, di-isodecyl phthalate, ethylene thiourea, methyl isobutyl ketone, methanol, toluene, lead and lead compounds which are known to the State of California to cause birth defects and other reproductive harm. For more information go to www.P65Warnings.ca.gov.

Sizes

Inside Diameters, Cross Sections and Tolerances for Aerospace Applications – Series A (ISO 3601-1)

Inside Dia. d ₁ (mm)		Cross-Section d ₂ (mm)					Inside Dia. d ₁ (mm)		Cross-Section d ₂ (mm)					Inside Dia. d ₁ (mm)		Cross-Section d ₂ (mm)								
		1.80±0.08	2.65±0.09	3.55±0.10	5.30±0.13	7.00±0.15			1.80±0.08	2.65±0.09	3.55±0.10	5.30±0.13	7.00±0.15			1.80±0.08	2.65±0.09	3.55±0.10	5.30±0.13	7.00±0.15				
	Tol. ±						Tol. ±						Tol. ±						Tol. ±					
1,8	0,13	x				30,0	0,27	x	x	x								112,0	0,74	x	x	x	x	x
2,0	0,13	x				31,5	0,28	x	x	x								115,0	0,76			x	x	x
2,24	0,13	x				32,5	0,29	x	x	x								118,0	0,77	x	x	x	x	x
2,5	0,13	x				33,5	0,29	x	x	x								122,0	0,80			x	x	x
2,8	0,13	x				34,5	0,3	x	x	x								125,0	0,81	x	x	x	x	x
3,15	0,13	x				35,5	0,31	x	x	x								128,0	0,83			x	x	x
3,55	0,13	x				36,5	0,31	x	x	x								132,0	0,85		x	x	x	x
3,75	0,13	x				37,5	0,32	x	x	x	x							136,0	0,87			x	x	x
4,0	0,13	x				38,7	0,32	x	x	x	x	x						140,0	0,89		x	x	x	x
4,5	0,13	x	x			40,0	0,33	x	x	x	x	x						145,0	0,92			x	x	x
4,87	0,13	x				41,2	0,34	x	x	x	x	x						150,0	0,95		x	x	x	x
5,0	0,13	x				42,5	0,35	x	x	x	x	x						155,0	0,98			x	x	x
5,15	0,13	x				43,7	0,35	x	x	x	x	x						160,0	1,00		x	x	x	x
5,3	0,13	x	x			45,0	0,36	x	x	x	x	x						165,0	1,03			x	x	x
5,6	0,13	x				46,2	0,37			x	x	x						170,0	1,06		x	x	x	x
6,0	0,13	x	x			47,5	0,38	x	x	x	x	x						175,0	1,09			x	x	x
6,3	0,13	x				48,7	0,38			x	x	x						180,0	1,11		x	x	x	x
6,7	0,13	x				50,0	0,39	x		x	x	x						185,0	1,14			x	x	x
6,9	0,14	x	x			51,5	0,40			x	x	x						190,0	1,17		x	x	x	x
7,1	0,14	x				53,0	0,41	x		x	x	x						195,0	1,20			x	x	x
7,5	0,14	x				54,5	0,42			x	x	x						200,0	1,22		x	x	x	x
8,0	0,14	x	x			56,0	0,42	x	x	x	x	x						206,0	1,26					x
8,5	0,15	x				58,0	0,44			x	x	x						212,0	1,29		x	x		x
8,75	0,15	x				60,0	0,45	x		x	x	x						218,0	1,32			x		x
9,0	0,15	x	x			61,5	0,45			x	x	x						224,0	1,35		x	x		x
9,5	0,15	x	x			63,0	0,46	x		x	x	x						230,0	1,39		x	x		x
10,0	0,15	x	x			65,0	0,48			x	x	x						236,0	1,42		x	x		x
10,6	0,16	x	x			67,0	0,49	x		x	x	x						243,0	1,46		x			x
11,2	0,16	x	x			69,0	0,50			x	x	x						250,0	1,49		x	x		x
11,8	0,17	x	x			71,0	0,51	x		x	x	x						258,0	1,54			x		x
12,5	0,17	x	x			73,0	0,52			x	x	x						265,0	1,57			x		x
13,2	0,17	x	x			75,0	0,53	x		x	x	x						272,0	1,61					x
14,0	0,18	x	x	x		77,5	0,55				x	x						280,0	1,65			x		x
15,0	0,18	x	x	x		80,0	0,56	x		x	x	x						290,0	1,71			x		x
16,0	0,19	x	x	x		82,5	0,57				x	x						300,0	1,76			x		x
17,0	0,20	x	x	x		85,0	0,59	x		x	x	x						307,0	1,80			x		x
18,0	0,20	x	x	x		87,5	0,60				x	x						315,0	1,84				x	
19,0	0,21	x	x	x		90,0	0,62	x		x	x	x						325,0	1,90					x
20,0	0,21	x	x	x		92,5	0,63				x	x						335,0	1,95			x		x
21,2	0,22	x	x	x		95,0	0,64	x		x	x	x						345,0	2,00					x
22,4	0,23	x	x	x		97,5	0,66				x	x						355,0	2,06			x		x
23,6	0,24	x	x	x		100,0	0,67	x		x	x	x						365,0	2,11					x
25,0	0,24	x	x	x		103,0	0,69				x	x						375,0	2,16					x
25,8	0,25	x	x	x		106,0	0,71	x		x	x	x						387,0	2,23					x
26,5	0,25	x	x	x		109,0	0,72				x	x	x					400,0	2,29					x

Table 9-5: Inside Diameters, Cross Sections and Tolerances for Aerospace Applications – Series A (ISO 3601-1)

WARNING: These products can expose you to chemicals including carbon black (airborne and extracts), antimony trioxide, titanium dioxide, silica (crystalline), di(2-ethylhexyl) phthalate, ethylene thiourea, acrylonitrile, 1,3-butadiene, epichlorohydrin, toluenediisocyanate, tetrafluoroethylene, ethylbenzene, formaldehyde, furfuryl alcohol, glass fibers, methyl isobutyl ketone, nickel (metallic and compounds), lead and lead compounds which are known to the State of California to cause cancer; and 1,3-butadiene, epichlorohydrin, di(2-ethylhexyl)phthalate, di-isodecyl phthalate, ethylene thiourea, methyl isobutyl ketone, methanol, toluene, lead and lead compounds which are known to the State of California to cause birth defects and other reproductive harm. For more information go to www.P65Warnings.ca.gov.

Inside Diameters, Cross Sections and Tolerances for Aerospace Applications – Series G (ISO3601-1)

Inside Dia. d ₁ (mm)		Cross-Section d ₂ (mm)					Inside Dia. d ₁ (mm)		Cross-Section d ₂ (mm)					Inside Dia. d ₁ (mm)		Cross-Section d ₂ (mm)				
	Tol. ±	1.80±0.08	2.65±0.09	3.55±0.10	5.30±0.13	7.00±0.15		Tol. ±	1.80±0.08	2.65±0.09	3.55±0.10	5.30±0.13	7.00±0.15		Tol. ±	1.80±0.08	2.65±0.09	3.55±0.10	5.30±0.13	7.00±0.15
		1,8	0,13	x							36,5	0,35				x	x			165,0
2,0	0,13	x					37,5	0,36		x	x			170,0	1,34			x	x	x
2,24	0,13	x					38,7	0,37		x	x			175,0	1,38			x	x	x
2,5	0,13	x					40,0	0,38			x	x		180,0	1,41			x	x	x
2,8	0,14	x					41,2	0,39			x	x		185,0	1,44			x	x	x
3,15	0,14	x					42,5	0,40			x	x		190,0	1,48			x	x	x
3,55	0,14	x					43,7	0,41			x	x		195,0	1,51			x	x	x
3,75	0,14	x					45,0	0,42			x	x		200,0	1,55			x	x	x
4,0	0,14	x					46,2	0,43			x	x		206,0	1,59			x	x	x
4,5	0,14	x					47,5	0,44			x	x		212,0	1,63			x	x	x
4,87	0,15	x					48,7	0,45			x	x		218,0	1,67			x	x	x
5,0	0,15	x					50,0	0,46			x	x		224,0	1,71			x	x	x
5,15	0,15	x					51,5	0,47			x	x		230,0	1,75			x	x	x
5,3	0,15	x					53,0	0,48			x	x		236,0	1,79			x	x	x
5,6	0,15	x					54,5	0,50			x	x		243,0	1,83			x	x	x
6,0	0,15	x					56,0	0,51			x	x		250,0	1,88			x	x	x
6,3	0,15	x					58,0	0,52			x	x		258,0	1,93			x	x	x
6,7	0,16	x					60,0	0,54			x	x		265,0	1,98			x	x	x
6,9	0,16	x					61,5	0,55			x	x		272,0	2,02			x	x	x
7,1	0,16	x					63,0	0,56			x	x		280,0	2,08			x	x	x
7,5	0,16	x					65,0	0,58			x	x		290,0	2,14			x	x	x
8,0	0,16	x					67,0	0,59			x	x		300,0	2,21			x	x	x
8,5	0,16	x					69,0	0,61			x	x		307,0	2,25			x	x	x
8,75	0,17	x					71,0	0,63			x	x		315,0	2,30			x	x	x
9,0	0,17	x					73,0	0,64			x	x		325,0	2,37			x	x	x
9,5	0,17	x					75,0	0,66			x	x		335,0	2,43			x	x	x
10,0	0,17	x					77,5	0,67			x	x		345,0	2,49			x	x	x
10,6	0,18	x					80,0	0,69			x	x		355,0	2,56			x	x	x
11,2	0,18	x					82,5	0,71			x	x		365,0	2,62			x	x	x
11,8	0,19	x					85,0	0,73			x	x		375,0	2,68			x	x	x
12,5	0,19	x					87,5	0,75			x	x		387,0	2,76			x	x	x
13,2	0,19	x					90,0	0,77			x	x		400,0	2,84			x	x	x
14,0	0,19	x	x				92,5	0,79			x	x		412,0	2,91			x	x	x
15,0	0,20	x	x				95,0	0,81			x	x		425,0	2,99			x	x	x
16,0	0,20	x	x				97,5	0,83			x	x		437,0	3,07			x	x	x
17,0	0,21	x	x				100,0	0,84			x	x		450,0	3,15			x	x	x
18,0	0,21		x	x			103,0	0,87			x	x		462,0	3,22			x	x	x
19,0	0,22		x	x			106,0	0,89			x	x		475,0	3,30			x	x	x
20,0	0,22		x	x			109,0	0,91			x	x	x	487,0	3,37			x	x	x
21,2	0,23		x	x			112,0	0,93			x	x	x	500,0	3,45			x	x	x
22,4	0,24		x	x			115,0	0,95			x	x	x	515,0	3,54			x	x	x
23,6	0,24		x	x			118,0	0,97			x	x	x	530,0	3,63			x	x	x
25,0	0,25		x	x			122,0	1,00			x	x	x	545,0	3,72			x	x	x
25,8	0,26		x	x			125,0	1,03			x	x	x	560,0	3,81			x	x	x
26,5	0,26		x	x			128,0	1,05			x	x	x	580,0	3,93			x	x	x
28,0	0,28		x	x			132,0	1,08			x	x	x	600,0	4,05			x	x	x
30,0	0,29		x	x			136,0	1,10			x	x	x	615,0	4,13			x	x	x
31,5	0,31		x	x			140,0	1,13			x	x	x	630,0	4,22			x	x	x
32,5	0,32		x	x			145,0	1,17			x	x	x	650,0	4,34			x	x	x
33,5	0,32		x	x			150,0	1,20			x	x	x	670,0	4,46			x	x	x
34,5	0,33		x	x			155,0	1,24			x	x	x							
35,5	0,34		x	x			160,0	1,27			x	x	x							

Table 9-6: Inside Diameters, Cross Sections and Tolerances for Aerospace Applications – Series G (ISO 3601-1)

WARNING: These products can expose you to chemicals including carbon black (airborne and extracts), antimony trioxide, titanium dioxide, silica (crystalline), di(2-ethylhexyl) phthalate, ethylene thiourea, acrylonitrile, 1,3-butadiene, epichlorohydrin, toluenediisocyanate, tetrafluoroethylene, ethylbenzene, formaldehyde, furfuryl alcohol, glass fibers, methyl isobutyl ketone, nickel (metallic and compounds), lead and lead compounds which are known to the State of California to cause cancer; and 1,3-butadiene, epichlorohydrin, di(2-ethylhexyl)phthalate, di-isodecyl phthalate, ethylene thiourea, methyl isobutyl ketone, methanol, toluene, lead and lead compounds which are known to the State of California to cause birth defects and other reproductive harm. For more information go to www.P65Warnings.ca.gov.

JIS B2401 Sizes

JIS B2401	Thickness		Inner Diameter		JIS B2401	Thickness		Inner Diameter		JIS B2401	Thickness		Inner Diameter	
	W (mm)		d (mm)			W (mm)		d (mm)			W (mm)		d (mm)	
P 3			2.8	±0.14	P 48			47.7	±0.44	P 200			199.5	±1.55
P 4			3.8	±0.14	P 49	3.5	±0.10	48.7	±0.45	P 205			204.5	±1.58
P 5			4.8	±0.15	P 50			49.7	±0.45	P 209			208.5	±1.61
P 6			5.8	±0.15						P 210			209.5	±1.62
P 7	1.9	±0.08	6.8	±0.16	P 48A			47.6	±0.45	P 215			214.5	±1.65
					P 50A			49.6	±0.45					
P 8			7.8	±0.16	P 52			51.6	±0.47	P 220			219.5	±1.68
P 9			8.8	±0.17	P 53			52.6	±0.48	P 225			224.5	±1.71
P 10			9.8	±0.17	P 55			54.6	±0.49	P 230			229.5	±1.75
										P 235			234.5	±1.78
P 10A			9.8	±0.17	P 56			55.6	±0.50	P 240			239.5	±1.81
P 11			10.8	±0.18	P 58			57.6	±0.52					
P 11.2			11.0	±0.18	P 60			59.6	±0.53	P 245	8.4	±0.15	244.5	±1.84
P 12			11.8	±0.19	P 62			61.6	±0.55	P 250			249.5	±1.88
P 12.5			12.3	±0.19	P 63			62.6	±0.56	P 255			254.5	±1.91
										P 260			259.5	±1.94
P 14			13.8	±0.19	P 65			64.6	±0.57	P 265			264.5	±1.97
P 15	2.4	±0.09	14.8	±0.20	P 67			66.6	±0.59					
P 16			15.8	±0.20	P 70			69.6	±0.61	P 270			269.5	±2.01
P 18			17.8	±0.21	P 71			70.6	±0.62	P 275			274.5	±2.04
P 20			19.8	±0.22	P 75			74.6	±0.65	P 280			279.5	±2.07
						5.7	±0.13			P 285			284.5	±2.10
P 21			20.8	±0.23	P 80			79.6	±0.69	P 290			289.5	±2.14
P 22			21.8	±0.24	P 85			84.6	±0.73					
					P 90			89.6	±0.77	P 295			294.5	±2.17
P 22A			21.7	±0.24	P 95			94.6	±0.81	P 300			299.5	±2.20
P 22.4			22.1	±0.24	P 100			99.6	±0.84	P 315			314.5	±2.30
P 24			23.7	±0.24						P 320			319.5	±2.33
P 25			24.7	±0.25	P 102			101.6	±0.85	P 335			334.5	±2.42
P 25.5			25.2	±0.25	P 105			104.6	±0.87					
					P 110			109.6	±0.91	P 340			339.5	±2.45
P 26			25.7	±0.26	P 112			111.6	±0.92	P 355			354.5	±2.54
P 28			27.7	±0.28	P 115			114.6	±0.94	P 360			359.5	±2.57
P 29			28.7	±0.29						P 375			374.5	±2.67
P 29.5			29.2	±0.29	P 120			119.6	±0.98	P 385			384.5	±2.73
P 30			29.7	±0.29	P 125			124.6	±1.01	P 400			399.5	±2.82
					P 130			129.6	±1.05					
P 31	3.5	±0.10	30.7	±0.30	P 132			131.6	±1.06	G 25			24.4	±0.25
P 31.5			31.2	±0.31	P 135			134.6	±1.09	G 30			29.4	±0.29
P 32			31.7	±0.31						G 35			34.4	±0.33
P 34			33.7	±0.33	P 140			139.6	±1.12	G 40			39.4	±0.37
P 35			34.7	±0.34	P 145			144.6	±1.16	G 45			44.4	±0.41
					P 150			149.6	±1.19					
P 35.5			35.2	±0.34						G 50			49.4	±0.45
P 36			35.7	±0.34	P 150A			149.5	±1.19	G 55			54.4	±0.49
P 38			37.7	±0.37	P 155			154.5	±1.23	G 60			50.4	±0.53
P 39			38.7	±0.37	P 160			159.5	±1.26	G 65			64.4	±0.57
P 40			39.7	±0.37	P 165			164.5	±1.30	G 70			69.4	±0.61
					P 170			169.5	±1.33					
P 41			40.7	±0.38						G 80			79.4	±0.69
P 42			41.7	±0.39						G 85	3.1	±0.10	84.4	±0.73
P 44			43.7	±0.41	P 175			174.5	±1.37	G 90			89.4	±0.77
P 45			44.7	±0.41	P 180			179.5	±1.40	G 95			94.4	±0.81
P 46			45.7	±0.42	P 185			184.5	±1.44					
					P 190			189.5	±1.48					
					P 195			194.5	±1.51					

Table 9-7: JIS B2401 Sizes

WARNING: These products can expose you to chemicals including carbon black (airborne and extracts), antimony trioxide, titanium dioxide, silica (crystalline), di(2-ethylhexyl) phthalate, ethylene thiourea, acrylonitrile, 1,3-butadiene, epichlorohydrin, toluenediisocyanate, tetrafluoroethylene, ethylbenzene, formaldehyde, furfuryl alcohol, glass fibers, methyl isobutyl ketone, nickel (metallic and compounds), lead and lead compounds which are known to the State of California to cause cancer; and 1,3-butadiene, epichlorohydrin, di(2-ethylhexyl)phthalate, di-isodecyl phthalate, ethylene thiourea, methyl isobutyl ketone, methanol, toluene, lead and lead compounds which are known to the State of California to cause birth defects and other reproductive harm. For more information go to www.P65Warnings.ca.gov.

JIS B2401 Sizes (Continued)

JIS B2401	Thickness		Inner Diameter		JIS B2401	Thickness		Inner Diameter		JIS B2401	Thickness		Inner Diameter	
	W (mm)		d (mm)			W (mm)		d (mm)			W (mm)		d (mm)	
G 100	3.1	±0.10	99.4	±0.85	G 200	5.7	±0.13	199.3	±1.55	G 300	5.7	±0.13	299.3	±2.20
G 105			104.4	±0.87	G 205			204.3	±1.58	G 305			304.3	±2.24
G 110			109.4	±0.91	G 210			209.3	±1.61	G 310			309.3	±2.27
G 115			114.4	±0.94	G 215			214.3	±1.64	G 315			314.3	±2.30
G 120			119.4	±0.98	G 220			219.3	±1.68	G 320			319.3	±2.33
G 125			124.4	±1.01	G 225			224.3	±1.71	G 325			324.3	±2.36
G 130			129.4	±1.05	G 230			229.3	±1.73	G 330			329.3	±2.39
G 135			134.4	±1.08	G 235			234.3	±1.77	G 335			334.3	±2.42
G 140			139.4	±1.12	G 240			239.3	±1.81	G 340			339.3	±2.45
G 145			144.4	±1.16	G 245			244.3	±1.84	G 345			344.3	±2.48
G 150	5.7	±0.13	149.3	±1.19	G 250	5.7	±0.13	249.3	±1.88	G 350	5.7	±0.13	349.3	±2.51
G 155			154.3	±1.23	G 255			254.3	±1.91	G 355			354.3	±2.54
G 160			159.3	±1.26	G 260			259.3	±1.94	G 360			359.3	±2.57
G 165			164.3	±1.30	G 265			264.3	±1.97	G 365			364.3	±2.60
G 170			169.3	±1.33	G 270			269.3	±2.01	G 370			369.3	±2.63
G 175			174.3	±1.37	G 275			274.3	±2.04	G 375			374.3	±2.67
G 180			179.3	±1.40	G 280			279.3	±2.07	G 380			379.3	±2.70
G 185			184.3	±1.44	G 285			284.3	±2.10	G 385			384.3	±2.73
G 190			189.3	±1.47	G 290			289.3	±2.14	G 390			389.3	±2.76
G 195			194.3	±1.51	G 295			294.3	±2.17	G 395			394.3	±2.79
										G 400			399.3	±2.82

Table 9-7: JIS B2401 Sizes



WARNING: These products can expose you to chemicals including carbon black (airborne and extracts), antimony trioxide, titanium dioxide, silica (crystalline), di(2-ethylhexyl) phthalate, ethylene thiourea, acrylonitrile, 1,3-butadiene, epichlorohydrin, toluenediisocyanate, tetrafluoroethylene, ethylbenzene, formaldehyde, furfuryl alcohol, glass fibers, methyl isobutyl ketone, nickel (metallic and compounds), lead and lead compounds which are known to the State of California to cause cancer; and 1,3-butadiene, epichlorohydrin, di(2-ethylhexyl)phthalate, di-isodecyl phthalate, ethylene thiourea, methyl isobutyl ketone, methanol, toluene, lead and lead compounds which are known to the State of California to cause birth defects and other reproductive harm. For more information go to www.P65Warnings.ca.gov.

Unusual Size Cross Reference to European O-Ring Codes and Sizes

Parker Size No.	MIL-P 5516 Class B Size No.	B.S. 1806 No.	UK Code No.	French Code No.	Parker Size No.	MIL-P 5516 Class B Size No.	B.S. 1806 No.	UK Code No.	French Code No.
2-004	-	-4	-	-	2-135	-	-135	-	-
2-005	-	-5	-	-	2-136	-	-136	-	-
2-006	AN6227B-1	-6	R.101	AN-1	2-137	-	-137	-	-
2-007	AN6227B-2	-7	R.102	AN-2	2-138	-	-138	-	-
2-008	AN6227B-3	-8	R.103	AN-3	2-139	-	-139	-	-
2-009	AN6227B-4	-9	R.104	AN-4	2-140	-	-140	-	-
2-010	AN6227B-5	-10	R.105	AN-5	2-141	-	-141	-	-
2-011	AN6227B-6	-11	R.107	AN-6	2-142	-	-142	-	-
2-012	AN6227B-7	-12	R.110	AN-7	2-143	-	-143	-	-
2-013	-	-13	-	-	2-144	-	-144	-	-
2-014	-	-14	-	-	2-145	-	-145	-	-
2-015	-	-15	-	-	2-146	-	-146	-	-
2-016	-	-16	-	-	2-147	-	-147	-	-
2-017	-	-17	-	-	2-148	-	-148	-	-
2-018	-	-18	-	-	2-149	-	-149	-	-
2-019	-	-19	-	-	2-210	AN6227B-15	-210	R.125	AN-15
2-020	-	-20	-	-	2-211	AN6227B-16	-211	R.126	AN-16
2-021	-	-21	-	-	2-212	AN6227B-17	-212	R.129	AN-17
2-022	-	-22	-	-	2-213	AN6227B-18	-213	R.131	AN-18
2-023	-	-23	-	-	2-214	AN6227B-19	-214	R.133	AN-19
2-024	-	-24	-	-	2-215	AN6227B-20	-215	R.135	AN-20
2-025	-	-25	-	-	2-216	AN6227B-21	-216	R.136	AN-21
2-026	-	-26	-	-	2-217	AN6227B-22	-217	R.137	AN-22
2-027	-	-27	-	-	2-218	AN6227B-23	-218	R.138	AN-23
2-028	-	-28	-	-	2-219	AN6227B-24	-219	R.139	AN-24
2-110	AN6227B-8	-110	R.111	AN-8	2-220	AN6227B-25	-220	R.140	AN-25
2-111	AN6227B-9	-111	R.113	AN-9	2-221	AN6227B-26	-221	R.141	AN-26
2-112	AN6227B-10	-112	R.116	AN-10	2-222	AN6227B-27	-222	R.142	AN-27
2-113	AN6227B-11	-113	R.118	AN-11	2-223	AN6230B-1	-223	R.146*	-
2-114	AN6227B-12	-114	R.120	AN-12	2-224	AN6230B-2	-224	R.149*	-
2-115	AN6227B-13	-115	R.122	AN-13	2-225	AN6230B-3	-225	R.152*	-
2-116	AN6227B-14	-116	R.124	AN-14	2-226	AN6230B-4	-226	R.155*	-
2-117	-	-117	R.127	-	2-227	AN6230B-5	-227	R.158*	-
2-118	-	-118	R.130*	-	2-228	AN6230B-6	-228	R.161*	-
2-119	-	-119	R.132*	-	2-229	AN6230B-7	-229	R.164*	-
2-120	-	-120	-	-	2-230	AN6230B-8	-230	R.167*	-
2-121	-	-121	-	-	2-231	AN6230B-9	-231	R.170*	-
2-122	-	-122	-	-	2-232	AN6230B-10	-232	R.173*	-
2-123	-	-123	-	-	2-233	AN6230B-11	-233	R.176*	-
2-124	-	-124	-	-	2-234	AN6230B-12	-234	-	-
2-125	-	-125	-	-	2-235	AN6230B-13	-235	-	-
2-126	-	-126	-	-	2-236	AN6230B-14	-236	-	-
2-127	-	-127	-	-	2-237	AN6230B-15	-237	-	-
2-128	-	-128	-	-	2-238	AN6230B-16	-238	-	-
2-129	-	-129	-	-	2-239	AN6230B-17	-239	-	-
2-130	-	-130	-	-	2-240	AN6230B-18	-240	-	-
2-131	-	-131	-	-	2-241	AN6230B-19	-241	-	-
2-132	-	-132	-	-	2-242	AN6230B-20	-242	-	-
2-133	-	-133	-	-	2-243	AN6230B-21	-243	-	-
2-134	-	-134	-	-	2-244	AN6230B-22	-244	-	-

Table 9-8: Unusual Size Cross Reference to European O-Ring Codes and Sizes

WARNING: These products can expose you to chemicals including carbon black (airborne and extracts), antimony trioxide, titanium dioxide, silica (crystalline), di(2-ethylhexyl) phthalate, ethylene thiourea, acrylonitrile, 1,3-butadiene, epichlorohydrin, toluenediisocyanate, tetrafluoroethylene, ethylbenzene, formaldehyde, furfuryl alcohol, glass fibers, methyl isobutyl ketone, nickel (metallic and compounds), lead and lead compounds which are known to the State of California to cause cancer; and 1,3-butadiene, epichlorohydrin, di(2-ethylhexyl)phthalate, di-isodecyl phthalate, ethylene thiourea, methyl isobutyl ketone, methanol, toluene, lead and lead compounds which are known to the State of California to cause birth defects and other reproductive harm. For more information go to www.P65Warnings.ca.gov.

Unusual Size Cross Reference to European O-Ring Codes and Sizes (Continued)

Parker Size No.	MIL-P 5516 Class B Size No.	B.S. 1806 No.	UK Code No.	French Code No.	Parker Size No.	MIL-P 5516 Class B Size No.	B.S. 1806 No.	UK Code No.	French Code No.
2-245	AN6230B-23	-245	-	-	2-340	AN6227B-43	-340	R.183	R-43
2-246	AN6230B-24	-246	-	-	2-341	AN6227B-44	-341	R.184	R-44
2-247	AN6230B-25	-247	-	-	2-342	AN6227B-45	-342	R.186	R-45
2-248	AN6230B-26	-248	-	-	2-343	AN6227B-46	-343	R.187	R-46
2-249	AN6230B-27	-249	-	-	2-344	AN6227B-47	-344	R.188	R-47
2-250	AN6230B-28	-250	-	-	2-345	AN6227B-48	-345	R.190	R-48
2-251	AN6230B-29	-251	-	-	2-346	AN6227B-49	-346	R.191	R-49
2-252	AN6230B-30	-252	-	-	2-347	AN6227B-50	-347	R.192	R-50
2-253	AN6230B-31	-253	-	-	2-348	AN6227B-51	-348	R.194	R-51
2-254	AN6230B-32	-254	-	-	2-349	AN6227B-52	-349	R.195	R-52
2-255	AN6230B-33	-255	-	-	2-425	AN6227B-88	-425	R.196	R-53
2-256	AN6230B-34	-256	-	-	2-426	AN6227B-53	-426	R.198	R-54
2-257	AN6230B-35	-257	-	-	2-427	AN6227B-54	-427	R.200	R-55
2-258	AN6230B-36	-258	-	-	2-428	AN6227B-55	-428	R.202	R-56
2-259	AN6230B-37	-259	-	-	2-429	AN6227B-56	-429	R.205	R-57
2-260	AN6230B-38	-260	-	-	2-430	AN6227B-57	-430	R.207	R-58
2-261	AN6230B-39	-261	-	-	2-431	AN6227B-58	-431	R.209	R-59
2-262	AN6230B-40	-262	-	-	2-432	AN6227B-59	-432	R.212	R-60
2-263	AN6230B-41	-263	-	-	2-433	AN6227B-60	-433	R.214	R-61
2-264	AN6230B-42	-264	-	-	2-434	AN6227B-61	-434	R.216	R-62
2-265	AN6230B-43	-265	-	-	2-435	AN6227B-62	-435	R.218	R-63
2-266	AN6230B-44	-266	-	-	2-436	AN6227B-63	-436	R.220	R-64
2-267	AN6230B-45	-267	-	-	2-437	AN6227B-64	-437	R.222	R-65
2-268	AN6230B-46	-268	-	-	2-438	AN6227B-65	-438	R.224	R-66
2-269	AN6230B-47	-269	-	-	2-439	AN6227B-66	-439	R.227	R-67
2-270	AN6230B-48	-270	-	-	2-440	AN6227B-67	-440	R.230	R-68
2-271	AN6230B-49	-271	-	-	2-441	AN6227B-68	-441	R.232	R-69
2-272	AN6230B-50	-272	-	-	2-442	AN6227B-69	-442	R.234	R-70
2-273	AN6230B-51	-273	-	-	2-443	AN6227B-70	-443	R.236	R-71
2-274	AN6230B-52	-274	-	-	2-444	AN6227B-71	-444	R.238	R-72
2-325	AN6227B-28	-325	R.143	R-28	2-445	AN6227B-72	-445	R.240	R-73
2-326	AN6227B-29	-326	R.145	R-29	2-446	AN6227B-73	-446	R.242	R-74
2-327	AN6227B-30	-327	R.148	R-30	2-447	AN6227B-74	-447	R.244	R-75
2-328	AN6227B-31	-328	R.151	R-31	2-248	AN6227B-75	-248	R.246	R-76
2-329	AN6227B-32	-329	R.154	R-32	2-249	AN6227B-76	-249	R.248	R-77
2-330	AN6227B-33	-330	R.157	R-33	2-450	AN6227B-77	-450	R.250	R-78
2-331	AN6227B-34	-331	R.160	R-34	2-451	AN6227B-78	-451	R.252	R-79
2-332	AN6227B-35	-332	R.163	R-35	2-452	AN6227B-79	-452	R.254	R-80
2-333	AN6227B-36	-333	R.166	R-36	2-453	AN6227B-80	-453	R.256	R-81
2-334	AN6227B-37	-334	R.169	R-37	2-454	AN6227B-81	-454	R.257	R-82
2-335	AN6227B-38	-335	R.172	R-38	2-455	AN6227B-82	-455	R.258	R-83
2-336	AN6227B-39	-336	R.175	R-39	2-456	AN6227B-83	-456	R.259	R-84
2-337	AN6227B-40	-337	R.179	R-40	2-457	AN6227B-84	-457	R.260	R-85
2-338	AN6227B-41	-338	R.180	R-41	2-458	AN6227B-85	-458	R.261	R-86
2-339	AN6227B-42	-339	R.182	R-42	2-459	AN6227B-86	-459	R.262	R-87

Table 9-8: Unusual Size Cross Reference to European O-Ring Codes and Sizes



WARNING: These products can expose you to chemicals including carbon black (airborne and extracts), antimony trioxide, titanium dioxide, silica (crystalline), di(2-ethylhexyl) phthalate, ethylene thiourea, acrylonitrile, 1,3-butadiene, epichlorohydrin, toluenediisocyanate, tetrafluoroethylene, ethylbenzene, formaldehyde, furfuryl alcohol, glass fibers, methyl isobutyl ketone, nickel (metallic and compounds), lead and lead compounds which are known to the State of California to cause cancer; and 1,3-butadiene, epichlorohydrin, di(2-ethylhexyl)phthalate, di-isodecyl phthalate, ethylene thiourea, methyl isobutyl ketone, methanol, toluene, lead and lead compounds which are known to the State of California to cause birth defects and other reproductive harm. For more information go to www.P65Warnings.ca.gov.

Unusual Size Cross Reference to European O-Ring Codes and Sizes (Continued)

Parker Size No.	UK Code No.	Parker Size No.	UK Code No.
5-052	R.106*	5-064	R.226*
5-612	R.108	5-434	R.233*
2-110	R.109*	5-445	R.241*
5-614	R.112	5-474	R.253*
5-613	R.114	5-578	R-1
5-615	R.115	5-579	R-2
5-616	R.117	5-580	R-3
5-243	R.119*	5-581	R-4
5-617	R.121	5-582	R-5
5-256	R.123*	5-583	R-5A
2-117	R.128	5-584	R-6
5-618	R.134*	5-585	R-6A
5-321	R.144	5-586	R-7
5-332	R.147	5-587	R-8
5-035	R.150*	5-588	R-9
5-701	R.153	5-589	R-10
5-037	R.156*	5-590	R-11
5-702	R.162	5-591	R-12
5-039	R.165*	5-592	R-13
5-703	R.168	5-593	R-14
5-361	R.171*	5-594	R-15
5-704	R.174	5-595	R-16
5-705	R.177	5-596	R-17
2-350	R.199*	5-597	R-18
2-351	R.201*	5-598	R-19
2-352	R.203*	5-599	R-20
2-353	R.206*	5-600	R-21
2-354	R.208*	5-601	R-22
2-355	R.210*	5-602	R-23
2-356	R.213*	5-603	R-24
2-357	R.215*	5-604	R-25
2-358	R.217*	5-605	R-26
2-359	R.219*	5-606	R-27
2-360	R.221*		

Table 9-8: Unusual Size Cross Reference to European O-Ring Codes and Sizes

O-Rings for Metric Tube Fittings (ISO 6149) (Similar to SAE J2244)

Port Thread	O-Ring Name	Parker Part No	ID mm	Tol. ± mm	W mm	Tol. ± mm
M8x1	M8 ISO O-Ring	0024-0063	6,10	0,13	1,60	0,08
M10x1	M10 ISO O-Ring	0031-9063	8,10	0,13	1,60	0,08
M12x1.5	M12 ISO O-Ring	0036-6087	9,30	0,13	2,20	0,08
M14x1.5	M14 ISO O-Ring	0044-5087	11,30	0,13	2,20	0,08
M16x1.5	M16 ISO O-Ring	0052-4087	13,30	0,15	2,20	0,08
M18x1.5	M18 ISO O-Ring	0060-2087	15,30	0,18	2,20	0,08
M22x1.5	M22 ISO O-Ring	0076-0087	19,30	0,20	2,20	0,08
M27x2	M27 ISO O-Ring	0092-9114	23,60	0,23	2,90	0,10
M33x2	M33 ISO O-Ring	0116-5114	29,60	0,30	2,90	0,10
M42x2	M42 ISO O-Ring	0152-0114	38,60	0,36	2,90	0,10
M48x2	M48 ISO O-Ring	0175-6114	44,60	0,41	2,90	0,10
M60x2	M60 ISO O-Ring	0222-8114	56,60	0,46	2,90	0,10

*Parker O-Ring Division is tooled in these sizes for Nitrile and Fluorocarbon rubber only. Contact the division for availability.

Design Table 9-9: O-Rings for Metric Tube Fittings (ISO 6149)

WARNING: These products can expose you to chemicals including carbon black (airborne and extracts), antimony trioxide, titanium dioxide, silica (crystalline), di(2-ethylhexyl) phthalate, ethylene thiourea, acrylonitrile, 1,3-butadiene, epichlorohydrin, toluenediisocyanate, tetrafluoroethylene, ethylbenzene, formaldehyde, furfuryl alcohol, glass fibers, methyl isobutyl ketone, nickel (metallic and compounds), lead and lead compounds which are known to the State of California to cause cancer; and 1,3-butadiene, epichlorohydrin, di(2-ethylhexyl)phthalate, di-isodecyl phthalate, ethylene thiourea, methyl isobutyl ketone, methanol, toluene, lead and lead compounds which are known to the State of California to cause birth defects and other reproductive harm. For more information go to www.P65Warnings.ca.gov.



WARNING: These products can expose you to chemicals including carbon black (airborne and extracts), antimony trioxide, titanium dioxide, silica (crystalline), di(2-ethylhexyl) phthalate, ethylene thiourea, acrylonitrile, 1,3-butadiene, epichlorohydrin, toluenediisocyanate, tetrafluoroethylene, ethylbenzene, formaldehyde, furfuryl alcohol, glass fibers, methyl isobutyl ketone, nickel (metallic and compounds), lead and lead compounds which are known to the State of California to cause cancer; and 1,3-butadiene, epichlorohydrin, di(2-ethylhexyl)phthalate, di-isodecyl phthalate, ethylene thiourea, methyl isobutyl ketone, methanol, toluene, lead and lead compounds which are known to the State of California to cause birth defects and other reproductive harm. For more information go to www.P65Warnings.ca.gov.

Section X – Appendix

10.1 O-Ring Failure Modes	10-2	10.2 Molded Elastomeric O-Ring Quality	
10.1.1 Why an O-Ring Fails Prematurely	10-2	Pass/Fail Limits	10-7
10.1.1.1 Compression Set	10-2	10.3 Glossary of Seal and Rubber Terms	10-9
10.1.1.2 Extrusion and Nibbling	10-3	10.4 Abbreviations	10-15
10.1.1.3 Spiral Failure	10-3	10.5 Standard Shrinkage	10-16
10.1.1.4 Explosive Decompression	10-4	10.5.1 Procedure for O-Rings Molded of	
10.1.1.5 Abrasion	10-4	Compounds Having Non-Standard	
10.1.1.6 Installation Damage	10-5	Shrinkage Rates	10-16
10.1.1.7 Other Causes of O-Ring Failure	10-5		
10.1.2 Assembly Hints	10-5		
10.1.2.1 Chamfers	10-5		
10.1.2.2 Traversing of Cross Drilled Ports	10-5		
10.1.2.3 Cleanliness and Cleaning Materials	10-6		
10.1.2.4 Stretching for Assembly	10-6		
10.1.2.5 Rolling	10-6		
10.1.2.6 Sharp Edges	10-6		
10.1.3 Failure Mode and Effects			
Analysis for Customers	10-6		

WARNING: These products can expose you to chemicals including carbon black (airborne and extracts), antimony trioxide, titanium dioxide, silica (crystalline), di(2-ethylhexyl) phthalate, ethylene thiourea, acrylonitrile, 1,3-butadiene, epichlorohydrin, toluenediisocyanate, tetrafluoroethylene, ethylbenzene, formaldehyde, furfuryl alcohol, glass fibers, methyl isobutyl ketone, nickel (metallic and compounds), lead and lead compounds which are known to the State of California to cause cancer; and 1,3-butadiene, epichlorohydrin, di(2-ethylhexyl)phthalate, di-isodecyl phthalate, ethylene thiourea, methyl isobutyl ketone, methanol, toluene, lead and lead compounds which are known to the State of California to cause birth defects and other reproductive harm. For more information go to www.P65Warnings.ca.gov.

Appendix

10.1. O-Ring Failure Modes

Like any device subject to judgment in design or to human error during installation, O-ring seals are susceptible to failure. The following brief summary of O-ring failure patterns is intended to give the designer/engineer a brief overview of the more common types of failure and a listing of recommended corrective actions. While there are a number of different types and causes of seal failure, we intend to cover only the types encountered most frequently. For a more complete listing of O-ring failure modes, Parker suggests the engineer obtain a copy of Publication AIR1707, Patterns of O-Ring Failure, available from:

SAE Inc.
 400 Commonwealth Drive
 Warrendale, PA 15095
www.sae.org

AIR1707, Patterns of O-Ring Failure, contains extensive material and some excellent photographs and will be most helpful for identifying the less common modes of O-ring failure not covered in this guide.

10.1.1 Why an O-Ring Fails Prematurely

The premature failure of an O-ring in service can usually be attributed to a combination of causes and not merely a single failure mode. It is important to maximize sealing life and reliability by reducing the probability of seal failure at the onset by the use of good design practices, proper compound selection, pre-production testing, and continued education and training of assembly personnel.

10.1.1.1 Compression Set

Probably the most common cause of O-ring failure is compression set. An effective O-ring seal requires a continuous “seal line” between the sealed surfaces. The establishment of this “seal line” is a function of gland design and seal cross-section which determines the correct amount of squeeze (compression) on the O-ring to maintain seal integrity without excessive deformation of the seal element. (See Section II, Basic O-Ring Elastomers, for an in-depth discussion of compression set and Section IV, Static O-Ring Sealing, for information on correct gland design.)

There are a number of factors that can contribute to compression set failure of an O-ring seal. They are listed below. Figure 10-1 provides an illustration of characteristic compression set. See Table 10-1 for a failure analysis and corrective action discussion.

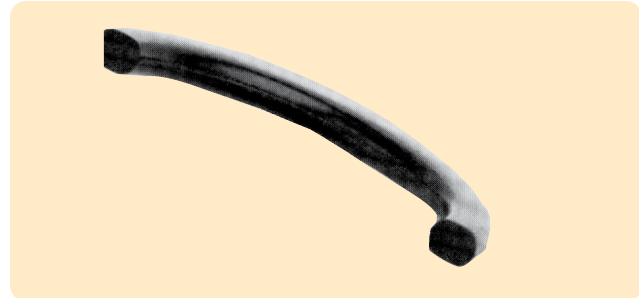

Figure 10-1: Characteristic compression set — high deformation -seen as flattening on all contact surfaces.

Compression Set

Failure Analysis

In general, Compression Set is caused by one or more of the following conditions:

1. Selection of O-ring material with inherently poor compression set properties.
2. Improper gland design.
3. Excessive temperature developed causing the O-ring to harden and lose its elastic properties. (High temperatures may be caused by system fluids, external environmental factors, or frictional heat build-up.)
4. Volume swell of the O-ring due to system fluid.
5. Excessive squeeze due to over tightening of adjustable glands.
6. Incomplete curing (vulcanization) of O-ring material during production.
7. Introduction of fluid incompatible with O-ring material.

Prevention/Correction

Suggested solutions to the causes of compression set are:

1. Use “Low-Set” O-ring material whenever possible.
2. Select O-ring material compatible with intended service conditions.
3. Reduce system operating temperature.
4. Check frictional heat build-up at seal interface and reduce if excessive.
5. Inspect incoming O-ring shipments for correct physical properties. (Requesting the Parker C.B.I. number will be of great assistance in this area. For a complete discussion of this exclusive Parker service, look later in this section.)

Identification of Compression Set Failure

A typical example of classic O-ring compression set in simplistic terms: the O-ring ceases to be “O” shaped and is permanently deformed into a flat sided oval, the flat sides of which were the original seal interface under compression before failure.

Table 10-1: Compression Set Failure Analysis



WARNING: These products can expose you to chemicals including carbon black (airborne and extracts), antimony trioxide, titanium dioxide, silica (crystalline), di(2-ethylhexyl) phthalate, ethylene thiourea, acrylonitrile, 1,3-butadiene, epichlorohydrin, toluenediisocyanate, tetrafluoroethylene, ethylbenzene, formaldehyde, furfuryl alcohol, glass fibers, methyl isobutyl ketone, nickel (metallic and compounds), lead and lead compounds which are known to the State of California to cause cancer; and 1,3-butadiene, epichlorohydrin, di(2-ethylhexyl)phthalate, di-isodecyl phthalate, ethylene thiourea, methyl isobutyl ketone, methanol, toluene, lead and lead compounds which are known to the State of California to cause birth defects and other reproductive harm. For more information go to www.P65Warnings.ca.gov.

10.1.1.2 Extrusion and Nibbling

Extrusion and nibbling of the O-ring is a primary cause of seal failure in dynamic applications such as hydraulic rod and piston seals. This form of failure may also be found from time to time in static applications subject to high pressure pulsing which causes the clearance gap of the mating flanges to open and close, trapping the O-ring between the mating surfaces. See Table 10-2 for a failure analysis and corrective action discussion. Figure 10-2 shows an example of an extruded and “nibbled” O-ring.



Figure 10-2: Extruded O-Ring

Extrusion and Nibbling

Failure Analysis

In general, extrusion and nibbling are caused by one or more of the following conditions:

1. Excessive clearances.
2. High pressure (in excess of system design or high pressure excursions).
3. O-ring material too soft.
4. Degradation (swelling, softening, shrinking, cracking, etc.) of O-ring material by system fluid.
5. Irregular clearance gaps caused by eccentricity.
6. Increase in clearance gaps due to excessive system pressure.
7. Improper machining of O-ring gland (sharp edges).
8. Improper size (too large) O-ring installed causing excessive filling of groove.

Prevention/Correction

Suggested solutions to the causes of Extrusion and Nibbling listed above are:

1. Decrease clearance by reducing machining tolerances.
2. Use back-up devices. (See Section VI, ParBack Back-Up Rings, for information on Parker Parbak anti-extrusion devices.)
3. Check O-ring material compatibility with system fluid.
4. Increase rigidity of metal components.
5. Replace current O-ring with a harder O-ring.
6. Break sharp edges of gland to a minimum radius 0.005 inches.
7. Insure installation of proper size O-rings.
8. Use alternative seal shape, for example, in some long stroke piston or rod applications, the Parker T-Seal, with its built-in back-up rings, may prevent extrusion and spiral failure.

Identification of Extrusion Failure

A typical example of O-ring extrusion is when edges of the ring on the low pressure or downstream side of the gland exhibit a “chewed” or “chipped” appearance. In an O-ring that has failed due to nibbling, it may have the appearance that many small pieces have been removed from the low pressure side. In some forms of extrusion, more than 50% of the O-ring may be destroyed before catastrophic leakage is observed.

Table 10-2: Extrusion and Nibbling Failure Analysis

10.1.1.3 Spiral Failure

Spiral failure of an O-ring is often found on long stroke hydraulic piston seals and to a lesser degree on rod seals. This type of O-ring failure is caused when the seal becomes “hung-up” at one point on its diameter (against the cylinder wall) and slides and rolls at the same time. The resultant twisting of the O-ring as the sealed device is cycled finally causes the seal to develop a series of deep spiral cuts (usually at a 45° angle) on the surface of the seal. (For more complete discussion on spiral failure, see Section IV, Static O-Ring Sealing).

Table 10-3 provides a discussion of spiral failure analysis. Figure 10-3 illustrates spiral failures.

Spiral Failure

Failure Analysis

As stated above, spiral failure is generally caused by an O-ring both sliding and rolling at the same time. Conditions which may cause this to occur are:

1. Eccentric components.
2. Wide clearance combined with side loads.
3. Uneven surface finishes.
4. Inadequate or improper lubrication.
5. O-ring too soft.
6. Stroke speed (usually too slow).
7. Improper installation (O-ring pinched or rolled).

Prevention/Correction

Suggested solutions to the causes of spiral failure are as follows:

1. Improve surface finish of sealed assembly at dynamic interface (Cylinder Bore, Piston Rod).
2. Check for out-of-round components (Cylinder Bores especially).
3. Provide proper lubrication. Consider the use of internally lubed O-rings.
4. Replace with a harder O-ring.
5. Consider use of alternate seal shapes. For example, the Parker T-seal is specifically designed to prevent spiral failure and its use will allow for increased tolerances because of built-in anti-extrusion back-up rings. Parker T-Seals are available to fit a number of standard AS568 O-ring grooves and may directly interchange with O-rings in most cases.

Identification of Spiral Failure

You will see the typical cuts that gave this type of O-ring failure its name.

Table 10-3: Spiral Analysis



Figure 10-3: Twisted O-ring with spiral marking, or with spiral cuts in surface

WARNING: These products can expose you to chemicals including carbon black (airborne and extracts), antimony trioxide, titanium dioxide, silica (crystalline), di(2-ethylhexyl) phthalate, ethylene thiourea, acrylonitrile, 1,3-butadiene, epichlorohydrin, toluenediisocyanate, tetrafluoroethylene, ethylbenzene, formaldehyde, furfuryl alcohol, glass fibers, methyl isobutyl ketone, nickel (metallic and compounds), lead and lead compounds which are known to the State of California to cause cancer; and 1,3-butadiene, epichlorohydrin, di(2-ethylhexyl)phthalate, di-isodecyl phthalate, ethylene thiourea, methyl isobutyl ketone, methanol, toluene, lead and lead compounds which are known to the State of California to cause birth defects and other reproductive harm. For more information go to www.P65Warnings.ca.gov.

10.1.1.4 Explosive Decompression

As system pressures increase we are seeing this type of O-ring failure with more frequency. It might be termed O-ring embolism, in that after a period of service under high pressure gas, when the pressure is reduced too rapidly, the gas trapped within the internal structure of the O-ring expands rapidly, causing small ruptures or embolisms on the O-ring surface.

Table 10-4 provides a failure analysis discussion. Figure 10-4 illustrates an O-ring damaged by explosive decompression.

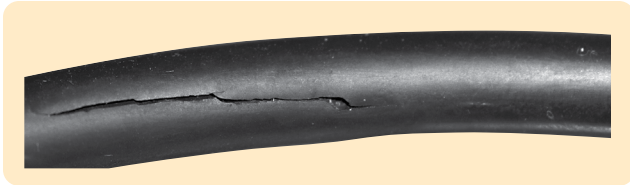

Figure 10-4: O-Ring Damaged by Explosive Decompression

Explosive Decompression

Failure Analysis

Explosive decompression or gas expansion rupture is caused by high pressure gas trapped within the internal structure of the elastomeric seal element. Rapid decrease in system pressure causes the trapped gas to expand to match the external pressure and this expansion causes blisters and ruptures on the seal surface. If the volume of trapped gas is small, the blisters may recede as the pressure is equalized with little effect on seal integrity. Excessive trapped gas may cause total destruction of the seal. (Refer to Section III, O-Ring Applications, for more information on this problem.)

Prevention/Correction

Suggested solutions to explosive decompression are:

1. Increase decompression time to allow trapped gas to work out of seal material.
2. Choose a seal material with good resistance to explosive decompression.
3. If problem persists and pressures are very high, consider use of Parker Metal Seals.

Identification of Explosive Decompression Failure

The seal subjected to explosive decompression will often exhibit small pits or blisters on its surface. In severe cases, examination of the internal structure of the O-ring will reveal other splits and fissures.

Table 10-4 Explosive Decompression Failure Analysis

10.1.1.5 Abrasion

Another rather common type of O-ring failure is abrasion. This usually is found only in dynamic seals subject either to reciprocating, oscillating, or rotary motion. Possible causes of O-ring abrasion are listed in Table 10-5. Figure 10-5 shows wear on an O-ring.

Abrasion

Failure Analysis

In general, abrasion of O-ring seals is caused by one or more of the following:

1. Improper finish of the surface in dynamic contact with the O-ring. This surface finish may be too rough, acting as an abrasive, or too smooth, causing inadequate lubrication due to inability of surface to hold lubricant.
2. Improper lubrication provided by system fluid.
3. Excessive temperatures.
4. Contamination of system fluid by abrasive particles.

Prevention/Correction

Suggested solutions to problems caused by abrasion are:

1. Use proper surface finish (see surface finish in Dynamic Seals section).
2. Provide adequate lubrication by use of proper system fluid.
3. Consider use of internally lubricated O-rings to reduce friction and wear.
4. Check for contamination of fluid and eliminate source. Install filters if necessary.
5. Consider changing to an O-ring material with improved abrasion resistance.

Table 10-5: Abrasion Failure Analysis



Figure 10-5: Wear is Seen as Flattening of O-ring on One Side



WARNING: These products can expose you to chemicals including carbon black (airborne and extracts), antimony trioxide, titanium dioxide, silica (crystalline), di(2-ethylhexyl) phthalate, ethylene thiourea, acrylonitrile, 1,3-butadiene, epichlorohydrin, toluenediisocyanate, tetrafluoroethylene, ethylbenzene, formaldehyde, furfuryl alcohol, glass fibers, methyl isobutyl ketone, nickel (metallic and compounds), lead and lead compounds which are known to the State of California to cause cancer; and 1,3-butadiene, epichlorohydrin, di(2-ethylhexyl)phthalate, di-isodecyl phthalate, ethylene thiourea, methyl isobutyl ketone, methanol, toluene, lead and lead compounds which are known to the State of California to cause birth defects and other reproductive harm. For more information go to www.P65Warnings.ca.gov.

10.1.1.6 Installation Damage

Many O-ring failures can be directly attributed to improper installation. In spite of its simple appearance, the O-ring is a precision device requiring care during installation. Some of the more frequent causes of O-ring failure due to careless handling are listed in Table 10-6.

Installation Damage

Failure Analysis

Damage to an O-ring during installation can occur when:

1. There are sharp corners on mating metal components such as the O-ring gland or threads over which the O-ring must pass during assembly.
2. Insufficient lead-in chamfer.
3. Blind grooves in multi-port valves.
4. Oversize O-ring on piston seal application.
5. Undersize O-ring on rod application.
6. O-ring twisted/pinched during installation.
7. O-ring not properly lubricated before installation.
8. O-ring dirty upon installation.
9. O-ring gland and/or other surfaces over which O-ring must pass during assembly contaminated with metal particles.
10. General Carelessness.

Prevention/Correction

Probably the best way to prevent damage to O-rings during installation is the use of good old-fashioned "Common Sense." There are some specific solutions which are listed below:

1. Break all sharp edges on metal components.
2. Provide a 20° lead-in chamfer.
3. Check all components for cleanliness before installation.
4. Tape all threads over which the O-ring will pass.
5. Use an O-ring lubricant such as Parker O-Lube or Parker Super O-Lube if its use will not contaminate system.
6. Double check O-ring to ensure correct size and material.
7. Be CAREFUL.

Table 10-6: Installation Damage Failure Analysis

10.1.1.7 Other Causes of O-Ring Failure

Damages to O-rings can be caused by compounding of the causes described in paragraphs 10.1.2.1 through 10.1.2.6. Upon failure of an O-ring check all causes mentioned above.

Although not illustrated here, there are several other possible causes of O-ring failure. They are:

1. Weather and ozone degradation
2. Heat aging and oxidation
3. Loss of plasticizer(s)

If you encounter an unusual type of O-ring failure or are unable to identify a particular failure mode, please feel free to contact the O-Ring Division Applications Engineering Department for assistance. In most cases these experienced engineers will be able to offer both an identification of the problem and a number of possible solutions.

10.1.2 Assembly Hints

Leak-free seals are achieved only when a proper sealing material is selected in the right size and sufficiently deformed. Correct deformation depends on observance of machine element tolerances and surface finishes. In practical terms all factors influencing the seal must be considered. Inadequate or improper assembly will lead to high servicing costs and subsequent downtime.

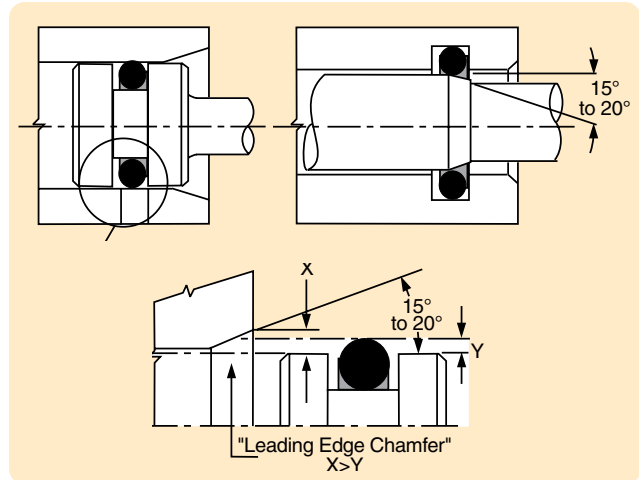

Figure 10-6: Chamfers

10.1.2.1 Chamfers

To prevent damaging of seals during assembly, chamfers are necessary on all leading edges. All edges must be free from burrs and sharp edges bevelled.

Figure 10-6 shows the leading edge chamfer and an O-ring before deformation. The dimension X should be greater than dimension Y to ensure a trouble-free assembly operation.

10.1.2.2 Traversing of Cross-Drilled Ports

An O-ring can be sheared when a spool or rod moves in a bore broken by cross-drilled ports. The deformed O-ring returns to its original round cross-section as it enters the port and is sheared as it leaves the drilled area. To avoid this, connection holes should be repositioned. If repositioning is not possible, an internal chamfer is recommended.

Optimal solution is the relief of the bore on complete circumference which allows the O-ring to return to a round cross-section before being compressed again. See Figure 10-7.

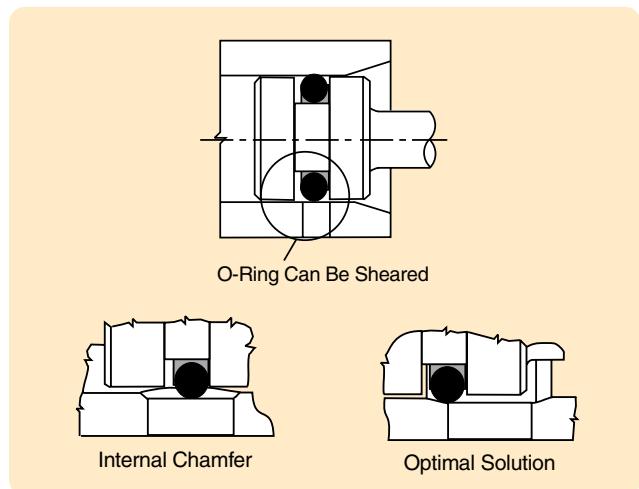

Figure 10-7: Drilled Port Assembly

WARNING: These products can expose you to chemicals including carbon black (airborne and extracts), antimony trioxide, titanium dioxide, silica (crystalline), di(2-ethylhexyl) phthalate, ethylene thiourea, acrylonitrile, 1,3-butadiene, epichlorohydrin, toluenediisocyanate, tetrafluoroethylene, ethylbenzene, formaldehyde, furfuryl alcohol, glass fibers, methyl isobutyl ketone, nickel (metallic and compounds), lead and lead compounds which are known to the State of California to cause cancer; and 1,3-butadiene, epichlorohydrin, di(2-ethylhexyl)phthalate, di-isodecyl phthalate, ethylene thiourea, methyl isobutyl ketone, methanol, toluene, lead and lead compounds which are known to the State of California to cause birth defects and other reproductive harm. For more information go to www.P65Warnings.ca.gov.

10.1.2.3 Cleanliness and Cleaning Materials

Lack of cleanliness of O-ring glands leads to leakage. To ensure protection from foreign particles of sealing faces during working life it is necessary to use filters or to plan maintenance cycles.

Cleaning material must also be a medium which is compatible with the elastomer. Also grease used to ease assembly must be compatible.

10.1.2.4 Stretching for Assembly

O-rings or back-up rings can be stretched during assembly by 50% of their inner diameters. With small inner diameters the percentage can be significantly greater eventually becoming critical.

It therefore is important to ensure that the stretch remains less than elongation at break given in compound data sheets. If an O-ring is stretched to near its elastic limit it will still return to its original size after a short delay.

10.1.2.5 Rolling

O-rings of large inner diameters and small cross-sections tend to roll during assembly. An O-ring rolled during fitting can be prone to spiral failure (cf. paragraph 10.1.2.3) or tend to leak. See Figure 10-8.

10.1.2.6 Sharp Edges

O-rings should not be forced over sharp edges, threads, slits, bores, glands, splines, etc. Such sharp edges must be removed or covered. Fitting aids assist assembly and thus avoid sharp edges. See Figures 10-9 and 10-10.

10.1.3 Failure Mode and Effects Analysis for Customers

Parker Seal has a wide network of people who are trained to analyze your requirements and assist in suggesting intelligent solutions to specific problems during all stages...design...prototype...testing...qualification...specification writing...and purchasing. All these services can be supplied by a trained Parker Territory Sales Manager or Parker Distributor.

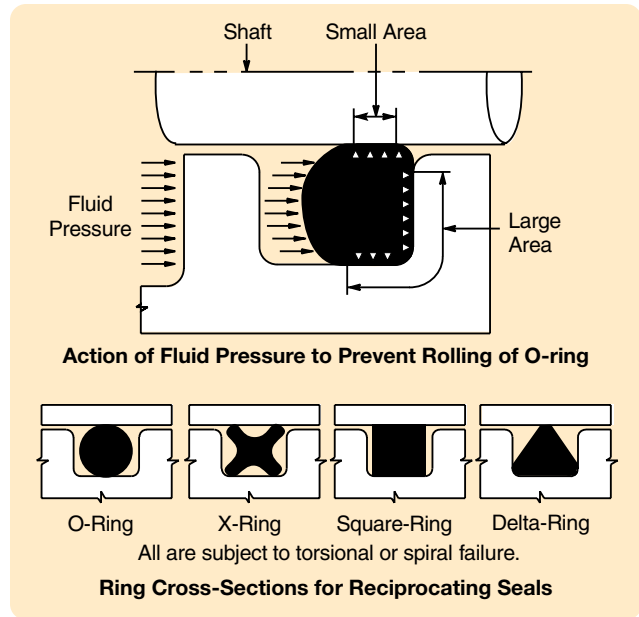

Figure 10-8: Rolling of O-ring

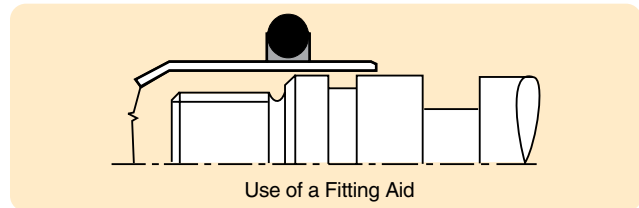

Figure 10-9: Use of a Fitting Aid

Parker Territory Sales Managers serving customers in the field are trained to recognize undesirable or uneconomical proposed applications in favor of those that are logical and cost efficient. You can count on your Parker Territory Sales Manager and your Parker Distributor to give you good counsel. They can help you in many ways — preparation of preliminary sketches, submission of working samples for test and evaluation, and even during qualification of a component or entire assembly.

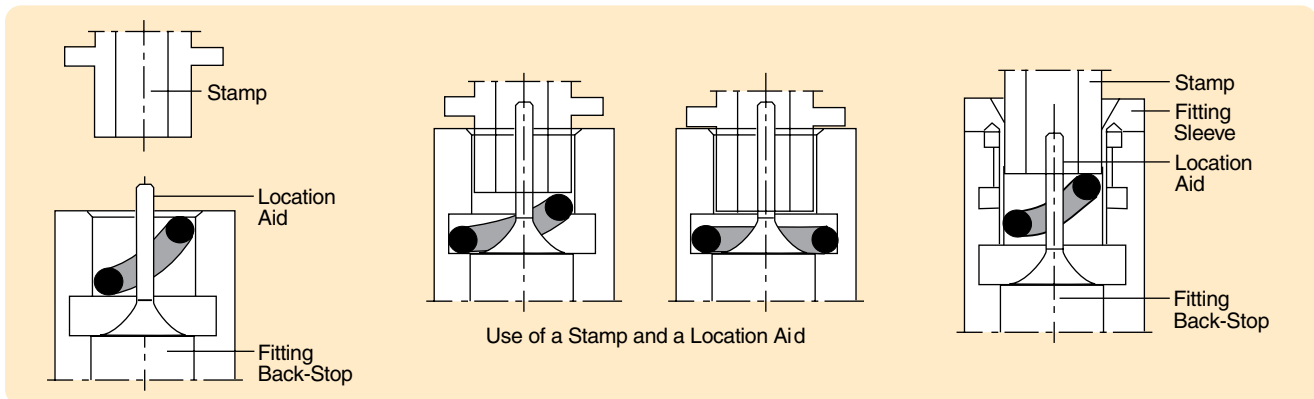

Figure 10-10: Use of a Stamp and a Location Aid

WARNING: These products can expose you to chemicals including carbon black (airborne and extracts), antimony trioxide, titanium dioxide, silica (crystalline), di(2-ethylhexyl) phthalate, ethylene thiourea, acrylonitrile, 1,3-butadiene, epichlorohydrin, toluenediisocyanate, tetrafluoroethylene, ethylbenzene, formaldehyde, furfuryl alcohol, glass fibers, methyl isobutyl ketone, nickel (metallic and compounds), lead and lead compounds which are known to the State of California to cause cancer; and 1,3-butadiene, epichlorohydrin, di(2-ethylhexyl)phthalate, di-isodecyl phthalate, ethylene thiourea, methyl isobutyl ketone, methanol, toluene, lead and lead compounds which are known to the State of California to cause birth defects and other reproductive harm. For more information go to www.P65Warnings.ca.gov.

Parker Seal also has the capability to analyze seals and their behavior in proposed applications through Finite Element Analysis (FEA). FEA is a powerful tool which allows the designer and the engineer to design complex parts and then verify with FEA mathematical models whether the design will perform under actual conditions. If the proposed design shows shortcomings under this modeling analysis, changes can easily be made in the design until acceptable performance is predicted by the model. All this can be done in a matter of days without investment in tooling, prototype parts, or physical testing. Parker engineers are available to help you with your sealing questions and all are fully qualified to recommend solutions to your sealing problems and how these problems can be corrected to prevent future failure. At Parker Seal, customer satisfaction is our goal. Our internal and field personnel are ready to help you with all your sealing needs, and your Authorized Parker Seal Distributor is a sealing expert who can assure you fast service and the kind of reliable seals you need, when you need them.



10.2 Molded Elastomeric O-Ring Quality Pass/Fail Limits

This section is intended to provide visual references regarding the standard published visual defect tolerances, which are dependant upon the actual cross section size of the subject O-ring. This information is based upon the industry standard MIL-STD-413C, which has subsequently been cancelled but is still in common use.

The pictures displayed do not necessarily represent an acceptable or defective product. They are intended to display examples of how a given defect may appear. Several of the noted defects may vary in actual physical representation as it relates to size and shape.

The use of other defect tolerance documents may apply if requested by the customer, and agreed upon at the time of quote. Unless requested otherwise, the requirements of MIL-STD-413C are utilized during the processing and inspection of Parker Seals O-Rings.

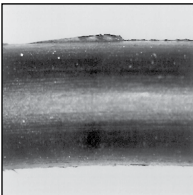
O-Ring Defect Description: MIL-STD-413C

Description	Definition	Cause	Tolerances for:																				
Excess Flash or Parting Line Projection 	Parting Line Projection: A continuous ridge of material on the parting line at the ID and/or OD. Flash: A film-like material which extends from the parting line on the ID, and/or OD, and may be superimposed on the parting line projection	Parting Line Projection: Enlarged corner radii due to mold wear (triangular formation). Excessive Flash: Mold plate separation or inadequate trim and deflash	Flash and/or Projection: <table border="1"> <thead> <tr> <th>Cross Section</th> <th>Depth</th> </tr> </thead> <tbody> <tr><td>.070</td><td>.003</td></tr> <tr><td>.103</td><td>.003</td></tr> <tr><td>.139</td><td>.004</td></tr> <tr><td>.210</td><td>.005</td></tr> <tr><td>.275</td><td>.006</td></tr> </tbody> </table>			Cross Section	Depth	.070	.003	.103	.003	.139	.004	.210	.005	.275	.006						
Cross Section	Depth																						
.070	.003																						
.103	.003																						
.139	.004																						
.210	.005																						
.275	.006																						
Flow Marks (Flow Lines) 	A thread-like recess, usually curved, of very slight depth with normal surface texture and radial edge.	Incomplete flow and knit of the material.	Flow Marks: <table border="1"> <thead> <tr> <th>Cross Section</th> <th>Depth</th> <th>Length</th> </tr> </thead> <tbody> <tr><td>.070</td><td>.002</td><td>.060</td></tr> <tr><td>.103</td><td>.002</td><td>.060</td></tr> <tr><td>.139</td><td>.002</td><td>.180</td></tr> <tr><td>.210</td><td>.002</td><td>.180</td></tr> <tr><td>.275</td><td>.002</td><td>.180</td></tr> </tbody> </table>			Cross Section	Depth	Length	.070	.002	.060	.103	.002	.060	.139	.002	.180	.210	.002	.180	.275	.002	.180
Cross Section	Depth	Length																					
.070	.002	.060																					
.103	.002	.060																					
.139	.002	.180																					
.210	.002	.180																					
.275	.002	.180																					
Foreign Material 	Any extraneous, imbedded matter, or depression formed by its removal.	Dirt, contamination, undispersed pigment, etc.	Foreign Material: No "protruding" foreign material is acceptable on any cross section. For depression formed by foreign material removal revert to Mold Deposit. Width is measured at widest direction. <table border="1"> <thead> <tr> <th>Cross section</th> <th>Depth</th> <th>Width</th> </tr> </thead> <tbody> <tr><td>.070</td><td>None</td><td>None</td></tr> <tr><td>.103</td><td>.003</td><td>.005</td></tr> <tr><td>.139</td><td>.004</td><td>.007</td></tr> <tr><td>.210</td><td>.005</td><td>.010</td></tr> <tr><td>.275</td><td>.006</td><td>.015</td></tr> </tbody> </table>			Cross section	Depth	Width	.070	None	None	.103	.003	.005	.139	.004	.007	.210	.005	.010	.275	.006	.015
Cross section	Depth	Width																					
.070	None	None																					
.103	.003	.005																					
.139	.004	.007																					
.210	.005	.010																					
.275	.006	.015																					

WARNING: These products can expose you to chemicals including carbon black (airborne and extracts), antimony trioxide, titanium dioxide, silica (crystalline), di(2-ethylhexyl) phthalate, ethylene thiourea, acrylonitrile, 1,3-butadiene, epichlorohydrin, toluenediisocyanate, tetrafluoroethylene, ethylbenzene, formaldehyde, furfuryl alcohol, glass fibers, methyl isobutyl ketone, nickel (metallic and compounds), lead and lead compounds which are known to the State of California to cause cancer; and 1,3-butadiene, epichlorohydrin, di(2-ethylhexyl)phthalate, di-isodecyl phthalate, ethylene thiourea, methyl isobutyl ketone, methanol, toluene, lead and lead compounds which are known to the State of California to cause birth defects and other reproductive harm. For more information go to www.P65Warnings.ca.gov.

O-Ring Defect Description: MIL-STD-413C (Continued)

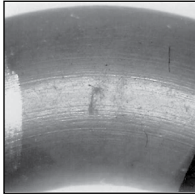
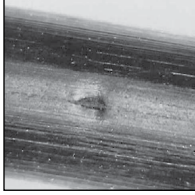
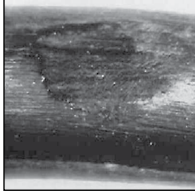
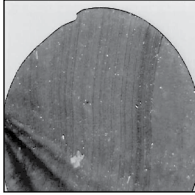
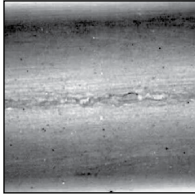
Description	Definition	Cause	Tolerances for:		
 <p>Mold Deposit (Dirty Mold)</p>	Surface indentations, irregular in shape, with a rough surface texture.	A build-up of hardened deposits adhering to the mold cavity.	Mold Deposit (Dirty Mold):		
			Cross section	Depth	Width
			.070	.003	.010
			.103	.003	.015
			.139	.004	.020
			.210	.004	.025
			.275	.005	.030
 <p>Nicks or Parting Line Indentation</p>	A shallow, saucer-like recess, sometimes triangular in shape, located on the parting line at the ID or OD, and usually divided by the parting line. The edges are smoothly flared into the O-ring surface and have similar texture.	A deformity in the mold cavity edge at the parting line.	Nicks or Parting Line Indentations:		
			Cross Section	Depth	Width
			.070	.003	.010
			.103	.003	.015
			.139	.004	.020
			.210	.005	.025
			.275	.006	.030
 <p>Non- Fill or Void</p>	A randomly spaced, irregularly shaped, surface indentation having a coarser texture than the normal O-ring surface. It may have molded edges which may or may not join.	Mold cavities not being completely filled with material.	Non-Fills or Voids:		
			Cross Section	Depth	Width
			.070	None allowed	None allowed
			.103	.002	.010
			.139	.003	.015
			.210	.003	.025
			.275	.003	.040
 <p>Off-Register and Mismatch</p>	Off-Register: Misaligned O-ring halves. Mismatch: Cross section of each half are different sizes.	Off-Register: Relative lateral shift of mold plates. Mismatch: Dimensional differences in the mold halves	Off-Register and/or Mismatch:		
			Cross Section	Maximum Allowed	
			.070	.003	
			.103	.004	
			.139	.005	
			.210	.006	
			.275	.006	
 <p>Backring</p>	A longitudinal recess of wide angle "U-like" or "W-like" cross sections orientated circumferentially and located only at parting lines.	Thermal expansion over a sharp mold edge or by premature cure.	Backring:		
			Edges, though smoothly faired into ring surface are irregular and can be present on full circumference on OD and/or ID within the following limits		
			Cross Section	Depth	Width
			.070	None	None
			.103	.003	.005
			.139	.004	.006
			.210	.004	.006
			.275	.005	.010

WARNING: These products can expose you to chemicals including carbon black (airborne and extracts), antimony trioxide, titanium dioxide, silica (crystalline), di(2-ethylhexyl) phthalate, ethylene thiourea, acrylonitrile, 1,3-butadiene, epichlorohydrin, toluenediisocyanate, tetrafluoroethylene, ethylbenzene, formaldehyde, furfuryl alcohol, glass fibers, methyl isobutyl ketone, nickel (metallic and compounds), lead and lead compounds which are known to the State of California to cause cancer; and 1,3-butadiene, epichlorohydrin, di(2-ethylhexyl)phthalate, di-isodecyl phthalate, ethylene thiourea, methyl isobutyl ketone, methanol, toluene, lead and lead compounds which are known to the State of California to cause birth defects and other reproductive harm. For more information go to www.P65Warnings.ca.gov.

10.3 Glossary of Seal and Rubber Terms

— A —

- Abrasion:** The wearing away of a surface in service by mechanical action such as rubbing, scraping or erosion.
- Abrasion Resistance:** The ability of a rubber compound to resist mechanical wear.
- Absorption:** The physical mechanism by which one substance attracts and takes up another substance (liquid, gas, or vapor) into its INTERIOR.
- Accelerated Life Test:** Any set of test conditions designed to reproduce in a short time the deteriorating effect obtained under normal service conditions.
- Accelerated Service Test:** A service or bench test in which some service condition, such as speed, or temperature, or continuity of operation, is exaggerated in order to obtain a result in shorter time.
- Accelerator:** A substance which hastens the vulcanization of an elastomer causing it to take place in a shorter time or at a lower temperature.
- Acid Resistant:** Withstands the action of acids.
- Adhere:** To cling or stick together.
- Adhesion:** Tendency of rubber to bond or cling to a contact surface.
- Adsorption:** The physical mechanism by which one substance attracts another substance (either solid, liquid, gas, or vapor) to its SURFACE and through molecular forces causes the incident substance to adhere thereon.
- Aging:** To undergo changes in physical properties with age or lapse of time.
- Aging, Oxygen Bomb:** A means of accelerating the change in physical properties of rubber compounds by exposing them to the action of oxygen at an elevated temperature and pressure.
- Air Bomb:** Similar to an oxygen bomb but used with air. Used for accelerated aging test.
- Air Checks:** Surface markings or depressions due to trapping air between the material being cured and the mold or press surface.
- Air Curing:** The vulcanization of a rubber product in air as distinguished from vulcanizing in a press or steam vulcanizer.
- Alpha (α) Particles:** Positively charged particles composed of two protons and neutrons (often referred to simply as helium atom nuclei) and characterized by limited penetration.
- Ambient Temperature:** The surrounding temperature relative to a given point of application.
Note: Ambient temperature is not necessarily the same as atmospheric temperature.
- Aniline Point:** The lowest temperature at which equal volumes of pure, fresh aniline and an oil will completely dissolve in one another.

- Antioxidant:** An organic substance which inhibits or retards oxidation.
- Antiozonant:** A substance that retards or prevents the appearance of cracks from the action of ozone when the elastomer is exposed under tension, either statically or dynamically, to air containing ozone.
- Antirad:** A material which inhibits radiation damage.
- Atmospheric Cracking:** Cracks produced in surface of rubber articles by exposure to atmospheric conditions.

— B —

- Backrind:** Distortion at the parting line usually in the form of a ragged indentation.
- Back-Up Ring:** (Anti-extrusion device) a ring of relatively hard and tough material placed in the gland between the O-ring and groove side walls, to prevent extrusion of the O-ring.
- Bake-Out:** A process whereby a vacuum system is heated for a given time at some predetermined temperature to degas all the components, i.e. gauges, fittings, valves, seals, etc.
- Banbury Mixer:** A specific type of internal mixer used to blend fillers and other ingredients with an elastomer.
- Bench Test:** A modified service test in which the service conditions are approximated, but the equipment is conventional laboratory equipment and not necessarily identical with that in which the product will be employed.
- Beta (β) Particles:** Negatively charged particles or electrons, characterized by limited penetration.
- Bleeding:** Migration to the surface of plasticizers, waxes, or similar materials to form a film or beads.
- Blemish:** A mark, deformity, or injury that impairs the appearance.
- Blisters:** A raised spot in the surface or a separation between layers usually forming a void or air-filled space in the vulcanized article.
- Bloom:** A dusty or milky looking deposit that sometimes appears on the surface of an O-ring after molding and storage, caused by migration of a liquid or solid to the surface. Not to be confused with dust from external sources.
- Bond:** The term commonly used to denote the attachment of a given elastomer to some other member. Bonds may be classified by type as follows:
- (a) Mechanical Bond — purely physical attachment accomplished by such means as “through” holes interlocking fingers, envelope design, riveting etc.
 - (b) “Cold” Bond — adhesion of previously vulcanized elastomer to another member through use of suitable contact cements.
 - (c) “Vulcanized” Bond — adhesion of an elastomer to a previously primed surface using heat and pressure thus vulcanizing the elastomer at the same time.
- Break:** A separation or discontinuity in any part of an article.
- Break-Out:** Force to initiate sliding. Expressed in same terms as friction. An excessive break-out value is taken as an indication of the development of adhesion.

WARNING: These products can expose you to chemicals including carbon black (airborne and extracts), antimony trioxide, titanium dioxide, silica (crystalline), di(2-ethylhexyl) phthalate, ethylene thiourea, acrylonitrile, 1,3-butadiene, epichlorohydrin, toluenediisocyanate, tetrafluoroethylene, ethylbenzene, formaldehyde, furfuryl alcohol, glass fibers, methyl isobutyl ketone, nickel (metallic and compounds), lead and lead compounds which are known to the State of California to cause cancer; and 1,3-butadiene, epichlorohydrin, di(2-ethylhexyl)phthalate, di-isodecyl phthalate, ethylene thiourea, methyl isobutyl ketone, methanol, toluene, lead and lead compounds which are known to the State of California to cause birth defects and other reproductive harm. For more information go to www.P65Warnings.ca.gov.

Brittleness: Tendency to crack when deformed.

Buna-N: Same as *nitrile* rubber.

Buna-S: A general term for the copolymers of butadiene and styrene. Also known as SBR and GRS.

Butt Joint: Joining two ends of a seal whereby the junction is perpendicular to the mold parting line.

Butyl: A copolymer of isobutylene with small amounts of isoprene.

– C –

Calender: A machine used to form sheets of rubber between steel rollers.

Coefficient of Thermal Expansion: Average expansion per degree over a stated temperature range expressed as a fraction of initial dimension. May be linear or volumetric.

Cold Flexibility: Flexibility following exposure to a predetermined low temperature for a predetermined time.

Cold Flow: Continued deformation under stress.

Cold Resistant: Able to withstand the effects of cold or low temperatures without loss of serviceability.

Commercially Smooth: Degree of smoothness of the surface of an article that is acceptable for use.

Compound: A term applied to a mixture of polymers and other ingredients, to produce a usable rubber material.

Compression Modulus: The ratio of the compressive stress to the resulting compressive strain (the latter expressed as a fraction of the original height or thickness in the direction of the force). Compression modulus may be either static or dynamic.

Compression Set: The amount by which a rubber specimen fails to return to original shape after release of compressive load.

Conductive Rubber: A rubber capable of conducting electricity. Most generally applied to rubber products used to conduct static electricity.

Copolymer: A polymer consisting of two different monomers chemically combined.

Corrosion (Packing): Corrosion of rigid member (usually metal) where it contacts packing. The actual corroding agent is fluid medium trapped in the interface.

Corrosive (Packing): A property of packing whereby it is assumed often incorrectly, to promote corrosion of the rigid member by the trapped fluid.

Cracking: A sharp break or fissure in the surface. Generally due to excessive strain.

Creep: The progressive relaxation of a given rubber material while it is under stress. This relaxation eventually results in permanent deformation or “set.”

Cross-Section: A seal as viewed if cut at right angles to the mold parting line showing internal structure.

Cure: See Vulcanization.

Cure Date: Date when O-ring was molded; i.e., 2Q94 means second quarter 1994.

Curing Temperature: The temperature at which the rubber product is vulcanized.

Cylinder: Chamber in which piston, plunger, ram, rod, or shaft is driven by or against the system fluid.

– D –

Degassing: The intentional **but controlled** OUTGAS of a rubber substance or other material.

Diffusion: The mixing of two or more substances (solids, liquids, gases, or combinations thereof) due to the intermingling motion of their individual molecules. Gases diffuse more readily than liquids; similarly, liquids diffuse more readily than solids.

Durometer:

- (a) An instrument for measuring the hardness of rubber. Measures the resistance to the penetration of an indentor point into the surface of rubber.
- (b) Numerical scale of rubber hardness.

Dynamic: An application in which the seal is subject to movement, or moving parts contact the seal.

Dynamic Packing: A packing employed in a joint whose members are in relative motion.

Dynamic Seal: A seal required to prevent leakage past parts which are in relative motion.

– E –

Elasticity: The property of an article which tends to return it to its original shape after deformation.

Elastomer: Any synthetic or natural material with resilience or memory sufficient to return to its original shape after major or minor distortion.

Electron Volt: Unit of energy in atom calculations equal to 1.602 E -12 ergs.

Elongation: Generally means “ultimate elongation” or percent increase in original length of a specimen when it breaks.

ERG: Unit of energy (C.G.S.) equal to one dyne centimeter or approximately equal to the work done by a force of 1 gram causing a movement of 1 centimeter.

Evaporation: The direct conversion from liquid state to vapor state of a given fluid.

Explosive Decompression: Rupturing of the substructure caused by the rapid removal of pressure from an elastomer containing dissolved gases. The result is a blistering or swelling of the material. Some elastomeric compounds are quite resistant to explosive decompression.

Extrusion: Distortion or flow, under pressure, of portion of seal into clearance between mating metal parts.

– F –

Face Seal: A seal between two flat surfaces.

Filler: Chemically inert, finely divided material added to the elastomer to aid in processing and improve physical properties, i.e., abrasion resistance and strength — giving it varying degrees of hardness.

WARNING: These products can expose you to chemicals including carbon black (airborne and extracts), antimony trioxide, titanium dioxide, silica (crystalline), di(2-ethylhexyl) phthalate, ethylene thiourea, acrylonitrile, 1,3-butadiene, epichlorohydrin, toluenediisocyanate, tetrafluoroethylene, ethylbenzene, formaldehyde, furfuryl alcohol, glass fibers, methyl isobutyl ketone, nickel (metallic and compounds), lead and lead compounds which are known to the State of California to cause cancer; and 1,3-butadiene, epichlorohydrin, di(2-ethylhexyl)phthalate, di-isodecyl phthalate, ethylene thiourea, methyl isobutyl ketone, methanol, toluene, lead and lead compounds which are known to the State of California to cause birth defects and other reproductive harm. For more information go to www.P65Warnings.ca.gov.

Flash: Excess rubber left around rubber part after molding due to space between mating mold surfaces; removed by trimming.

Flex Cracking: A surface cracking induced by repeated bending or flexing.

Flex Resistance: The relative ability of a rubber article to withstand dynamic bending stresses.

Flock: Fibrous filler sometimes used in rubber compounding.

Flow Cracks: Surface imperfections due to improper flow and failure of stock to knit or blend with itself during the molding operation.

Fluid: A liquid or a gas.

Friction: Resistance to motion due to the contact of surfaces.

Friction (Breakout): Friction developed during initial or starting motion.

Friction (Running): Constant friction developed during operation of a dynamic O-ring.

Fuel (Aromatic): Fuel which contains benzene or aromatic hydrocarbons. Causes high swell of rubber.

Fuel (Nonaromatic): Fuel which is composed of straight chain hydrocarbons. Causes little swell of rubber.

– G –

Gamma (γ) Radiation: Electromagnetic disturbance (photons) emanating from an atom nucleus. This type of radiation travels in wave form much like X-rays or light, but has a shorter wave length (approx. 1 \AA or $10 \text{ E}^{-07} \text{ mm}$). It is very penetrating.

Gasket: A device used to retain fluids under pressure or seal out foreign matter. Normally refers to a static seal.

Gland: Cavity into which O-ring is installed. Includes the groove and mating surface of second part which together confine the O-ring.

– H –

Hardness: Resistance to a distorting force. Measured by the relative resistance of the material to an indenter point of any one of a number of standard hardness testing instruments.

Hardness Shore A: The rubber durometer hardness as measured on a Shore "A" gauge. Higher numbers indicate harder material. 35 Shore "A" durometer reading is considered soft. 90 is considered hard.

Hermetic Seal: An airtight seal evidencing no detectable leakage.

Homogeneous:

- (a) General - a material of uniform composition throughout.
- (b) In seals - a rubber seal without fabric or metal reinforcement.

Hypalon: DuPont trade name for chlorosulphonated polyethylene, an elastomer.

– I –

Identification: Colored dots or stripes on seals for identification purposes.

Immediate Set: The deformation found by measurement immediately after removal of the load causing the deformation.

Immersion: Placing an article into a fluid, generally so it is completely covered.

Impact: The single, instantaneous stroke or contact of a moving body with another, either moving or at rest, such as a large lump of material dropping on a conveyor belt.

– L –

Leakage Rate: The rate at which a fluid (either gas or liquid) passes a barrier. Total Leakage Rate includes the amounts that diffuse or permeate through the material of the barrier as well as the amount that escapes around it.

Life Test: A laboratory procedure used to determine the amount and duration of resistance of an article to a specific set of destructive forces or conditions.

Linear Expansion: Expansion in any one linear dimension or the average of all linear dimensions.

Logy: Sluggish, low snap or recovery of a material.

Low Temperature Flexibility: The ability of a rubber product to be flexed, bent or bowed at low temperatures without cracking.

– M –

mm Hg: Millimeters of mercury. In vacuum work, this is a measure of absolute pressure, being the height of a column of mercury that the air or other gas will support. Standard atmospheric pressure will support a mercury column 760 millimeters high (760 mm Hg.) Any value less than this represents some degree of vacuum.

Memory: Tendency of a material to return to original shape after deformation.

Mirror Finish: A bright, polished surface.

Mismatch: Unsymmetrical seal caused by dissimilar cavities in mating mold sections.

Modulus: Tensile stress at a specified elongation. (Usually 100% elongation for elastomers).

Modulus of Elasticity: One of the several measurements of stiffness or resistance to deformation, but often incorrectly used to indicate specifically static tension modulus.

Mold Cavity: Hollow space or cavity in the mold which is used to impart the desired form to the product being molded.

Mold Finish: The uninterrupted surface produced by intimate contact of rubber with the surface of the mold at vulcanization.

Mold Lubricant: A material usually sprayed onto the mold cavity surface prior to the introduction of the uncured rubber, to facilitate the easy removal of the molded rubber parts.

Mold Marks: Indentations or ridges embossed into the skin of the molded product by irregularities in the mold cavity surface.

WARNING: These products can expose you to chemicals including carbon black (airborne and extracts), antimony trioxide, titanium dioxide, silica (crystalline), di(2-ethylhexyl) phthalate, ethylene thiourea, acrylonitrile, 1,3-butadiene, epichlorohydrin, toluenediisocyanate, tetrafluoroethylene, ethylbenzene, formaldehyde, furfuryl alcohol, glass fibers, methyl isobutyl ketone, nickel (metallic and compounds), lead and lead compounds which are known to the State of California to cause cancer; and 1,3-butadiene, epichlorohydrin, di(2-ethylhexyl)phthalate, di-isodecyl phthalate, ethylene thiourea, methyl isobutyl ketone, methanol, toluene, lead and lead compounds which are known to the State of California to cause birth defects and other reproductive harm. For more information go to www.P65Warnings.ca.gov.

Mold Register: Accuracy of alignment or fit of mold sections.

Mooney Scorch: The measurement of the rate at which a rubber compound will cure or set up by means of the Mooney Viscometer test instrument.

Mooney Viscosity: The measurement of the plasticity or viscosity of an uncompounded or compounded, unvulcanized, elastomeric seal material by means of the Mooney Shearing Disk Viscometer.

– N –

Nitrile: (Buna-N) The most commonly used elastomer for O-rings because of its resistance to petroleum fluids, good physical properties and useful temperature range.

Nominal Dimension: Nearest fractional equivalent to actual decimal dimension.

Non-Blooming: The absence of bloom.

– O –

Occlusion:

- (a) The mechanical process by which vapors, gases, liquids, or solids are entrapped within the folds of a given substance during working or solidification.
- (b) The materials so trapped.

Off-Register: Misalignment of mold halves causing out-of-round O-ring cross section.

Oil Resistant: Ability of a vulcanized rubber to resist the swelling and deteriorating effects of various type oils.

Oil Swell: The change in volume of a rubber article due to absorption of oil or other or other fluid.

O-Ring: A torus; a circle of material with round cross section which effects a seal through squeeze and pressure.

O-Ring Seal: The combination of a gland and an O-ring providing a fluid-tight closure. (Some designs may permit momentary or minimum leakage.)

Moving (dynamic) — O-ring seal in which there is relative motion between some gland parts and the O-ring — oscillating, reciprocating, or rotary motion.

Non-moving (static) — O-ring seal in which there is no relative motion between any part of the gland and the O-ring (distortion from fluid pressure or swell from fluid immersion is excluded).

Optimum Cure: State of vulcanization at which the most desirable combination of properties is attained.

Outgassing: A vacuum phenomenon wherein a substance spontaneously releases volatile constituents in the form of vapors or gases. In rubber compounds, these constituents may include water vapor, plasticizers, air, inhibitors, etc.

Over Cure: A degree of cure greater than the optimum causing some desirable properties to be degraded.

Oxidation: The reaction of oxygen on a compound usual detected by a change in the appearance or feel of the surface, or by a change in physical properties or both.

Oxygen Bomb: A chamber capable of holding oxygen at an elevated pressure which can be heated to an elevated temperature. Used for an accelerated aging test.

Ozone Resistance: Ability to withstand the deteriorating effect of ozone (which generally causes cracking).

– P –

Packing: A flexible device used to retain fluids under pressure or seal out foreign matter. Normally refers to a dynamic seal.

Permanent Set: The deformation remaining after a specimen has been stressed in tension for a definite period and released for a definite period.

Permeability: The rate at which a liquid or gas under pressure passes through a solid material by diffusion and solution. In rubber terminology, it is the rate of gas flow expressed in atmospheric cubic centimeters per second through an elastomeric material one centimeter square and one centimeter thick (atm cc/cm²/cm sec).

Pit or Pock Mark: A circular depression, usually small.

Plasticizer: A substance, usually a viscous liquid, added to an elastomer to decrease stiffness, improve low temperature properties, and improve processing.

Plastometer: An instrument for measuring the plasticity of raw or unvulcanized compounded rubber.

Pock Mark: See “Pit or Pock Mark”.

Polymer: A material formed by the joining together of many (poly) individual units (mer) of one or more monomers; synonymous with elastomer.

Porosity: Quality or state of being porous.

Post Cure: The second step in the vulcanization process for the more exotic elastomers. Provides stabilization of parts and drives off decomposition products resulting from the vulcanization process.

– R –

Radiation: An emission of varying energy content from a disturbed atom undergoing internal change. There are two broad classifications or types:

- (a) **Corpuscular**, comprising streams of **particles** either neutral or charged, e.g. protons, electrons, neutrons.
- (b) **Electromagnetic**, comprising **wave-like** emissions as gamma, ultraviolet, etc.

Radiation Damage: A measure of the loss in certain physical properties of organic substances such as elastomers, due principally to ionization of the long chain molecule. It is believed that this ionization process (i.e. electron loss) results in redundant cross-linking and possible scission of the molecule. This effect is **cumulative**.

Radiation Dosage: The total amount of radiation energy absorbed by a substance. This value is usually expressed in ergs per gram, and is denoted by the following units:

- (a) **Roentgen** - a quantity of gamma or X-ray radiation equal to approximately 83 ergs of absorbed energy per gram of air.



WARNING: These products can expose you to chemicals including carbon black (airborne and extracts), antimony trioxide, titanium dioxide, silica (crystalline), di(2-ethylhexyl) phthalate, ethylene thiourea, acrylonitrile, 1,3-butadiene, epichlorohydrin, toluenediisocyanate, tetrafluoroethylene, ethylbenzene, formaldehyde, furfuryl alcohol, glass fibers, methyl isobutyl ketone, nickel (metallic and compounds), lead and lead compounds which are known to the State of California to cause cancer; and 1,3-butadiene, epichlorohydrin, di(2-ethylhexyl)phthalate, di-isodecyl phthalate, ethylene thiourea, methyl isobutyl ketone, methanol, toluene, lead and lead compounds which are known to the State of California to cause birth defects and other reproductive harm. For more information go to www.P65Warnings.ca.gov.

- (b) **REP** (Roentgen equivalent-physical) - a quantity of ionizing radiation that causes an energy absorption of approximately 83 to 93 ergs per gram of tissue.
- (c) **REM** (Roentgen equivalent-man)—similar to REP except used to denote biological effects.
- (d) **RAD** - the unit of dosage related to elastomers. It is independent of type of radiation or specimen, and denotes an energy absorption level of 100 ergs per gram (of elastomer). The RAD is approximately equal to 1.2 Roentgens.

Register, Off or Uneven: See Off-register.

Reinforcing Agent: Material dispersed in an elastomer to improve compression, shear or other stress properties.

Relative Humidity: The ratio of the quantity of water vapor actually present in the atmosphere to the greatest amount possible at the given temperature.

Resilient: Capable of returning to original size and shape after deformation.

Roentgen: See Radiation Dosage.

Rough Trim: Removal of superfluous material by pulling or picking. Usually the removal of a small portion of the flash or sprue which remains attached to the product.

Rubber: Same as elastomer.

Rubber, Natural: Raw or crude rubber obtained from plant sources.

Rubber, Synthetic: Manufactured or man-made elastomers.

Runout (Shaft): Same as gyration; when expressed in inches alone or accompanied by abbreviation "T.I.R." (total indicator reading), it refers to twice the radial distance between shaft axis and axis of rotation.

— S —

Scorching: Premature curing or setting up of raw compound during processing.

Seal: Any device used to prevent the passage of a fluid (gas or liquid).

Service: Operating conditions to be met.

Shaft: Reciprocating or rotating member usually within cylinder; not in contact with walls.

Shelf-Aging: The change in a material's properties which occurs in storage with time.

Shore A Hardness: See Hardness and Durometer.

Shrinkage: a) Decreased volume of seal, usually caused by extraction of soluble constituents by fluids followed by air drying. b) Difference between finished part dimensions and mold cavity used to make the part.

Silicone Rubber: Elastomer that retains good properties through extra wide temperature range.

Size, Actual: Actual dimensions of the O-ring or other seal, including tolerance limits.

Size, Nominal: Approximate size of part in fractional dimensions. May also indicate the actual size of the groove into which a nominal size seal fits.

Size Number: Number assigned to indicate inside and cross section diameters of an O-ring. Sizes established in SAE standard AS 568A have been adopted by the military and industry.

Sorption: The term used to denote the combination of absorption and adsorption processes in the same substance.

Specific Gravity: The ratio of the weight of a given substance to the weight of an equal volume of water at a specified temperature.

Sprue Marks: Marks left on the surface of a rubber part, usually elevated, after removal of the sprue or cured compound in the gate through which the compound is injected or transfer molded.

Squeeze: Cross section diametral compression of O-ring between surface of the groove bottom and surface of other mating metal part in the gland assembly.

Static Seal: Part designed to seal between parts having no relative motion. See Gasket.

Strain: Deflection due to a force.

Stress: Force per unit of original cross section area.

Sublimation: The direct conversion of a substance from **solid** state to **vapor** state without passing through a transitory liquid state. The **vapor**, upon recondensing, reforms into the **solid** state with no intervening liquid phase.

Sun Checking: Surface cracks, checks or crazing caused by exposure to direct or indirect sunlight.

Swell: Increased volume of a specimen caused by immersion in a fluid (usually a liquid).

— T —

Tear Resistance: Resistance to growth of a cut or nick when tension is applied to the cut specimen. Commonly expressed as pounds per inch thickness.

Temperature Range: Maximum and minimum temperature limits within which a seal compound will function in a given application.

Tensile Strength: Force in pounds per square inch required to cause the rupture of a specimen of a rubber material.

Terpolymer: A polymer consisting of three different monomers chemically combined.

Thermal Expansion: Expansion caused by increase in temperature. May be linear or volumetric.

Threshold: The maximum tolerance of an elastomer to radiation dosage expressed as a total number of ergs per gram (or rads) beyond which the physical properties are significantly degraded. This is generally an arbitrary value, depending on function and environment.

Torque: The turning force of a shaft.



WARNING: These products can expose you to chemicals including carbon black (airborne and extracts), antimony trioxide, titanium dioxide, silica (crystalline), di(2-ethylhexyl) phthalate, ethylene thiourea, acrylonitrile, 1,3-butadiene, epichlorohydrin, toluenediisocyanate, tetrafluoroethylene, ethylbenzene, formaldehyde, furfuryl alcohol, glass fibers, methyl isobutyl ketone, nickel (metallic and compounds), lead and lead compounds which are known to the State of California to cause cancer; and 1,3-butadiene, epichlorohydrin, di(2-ethylhexyl)phthalate, di-isodecyl phthalate, ethylene thiourea, methyl isobutyl ketone, methanol, toluene, lead and lead compounds which are known to the State of California to cause birth defects and other reproductive harm. For more information go to www.P65Warnings.ca.gov.

Torr: The unit of pressure used in vacuum measurement. It is equal to 1/760 of a standard atmosphere, and for all practical purposes is equivalent to one millimeter of mercury (mm Hg).

Example:

- 25 mm Hg = 25 torr
- 1×10^{-3} mm Hg = 10^{-3} torr (millitorr)
- 1×10^{-6} mm Hg = 10^{-6} torr (microtorr)

Torsional Strength: Ability of rubber to withstand twisting.

TR-10: (10% Temperature retraction) A measure of the low temperature capability of an elastomer, being the temperature at which a stretched and frozen specimen has retracted by 10% of the stretched amount. (ASTM method D1329)

Trapped Air: Air which is trapped in a product or a mold during cure. Usually causes a loose ply or cover, or a surface mark, depression or void.

Trim: The process involving removal of mold flash.

Trim Cut: Damage to mold skin or finish by too close trimming.

– U –

Under-Cure: Degree of cure less than optimum. May be evidenced by tackiness, loginess, or inferior physical properties.

Ultimate Elongation: See Elongation.

– V –

Vacuum: The term denoting a given space that is occupied by a gas at less than atmospheric pressure. For degrees of vacuum; see vacuum level.

Vacuum Level: The term used to denote the degree of vacuum evidenced by its pressure in torr (or mm Hg).

- (a) **Rough** vacuum — 760 torr to 1 torr
- (b) Medium vacuum — 1 torr to 10^{-3} torr
- (c) High vacuum — 10^{-3} torr to 10^{-6} torr
- (d) Very high (hard) vacuum — 10^{-6} torr to 10^{-9} torr
- (e) Ultra **high** (ultra hard) vacuum — Below 10^{-9} torr

Vapor: The gaseous state of a fluid that normally exists as a liquid under atmospheric conditions, i.e. a gas whose temperature is below its critical temperature.

Vapor Pressure: The maximum pressure exerted by a liquid (or solid) heated to a given temperature in a closed container.

Virtual Leak: An “apparent” leak in a vacuum system that is traceable, in fact, to some internal (and often accidental) release of occluded and/or sorbed gases.

Example:

An undetected blister in a fused joint may eventually break down in a vacuum and suddenly (or slowly) release its entrapped air, thereby indicating a “leak.”

Viscosity: The property of fluids and plastic solids by which they resist an instantaneous change of shape, i.e., resistance to flow.

Void: The absence of material or an area devoid of materials where not intended.

Volatilization: The transition of either a liquid or a solid directly into the vapor state. In the case of a liquid, this transition is called evaporation, whereas in the case of a solid, it is termed sublimation.

Volume Change: A change in the volume of a seal as a result of immersion in a fluid expressed as a percentage of the original volume.

Volume Swell: Increase in physical size caused by the swelling action of a liquid.

Vulcanization: A thermo-setting reaction involving the use of heat and pressure, resulting in greatly increased strength and elasticity of rubber-like materials.

Vulcanizing Agent: A material which produces vulcanization of an elastomer.

– W –

Width: Seal cross section or thickness.

Wiper Ring: A ring employed to remove excess fluid, mud, etc., from a reciprocating member before it reaches the packings.



WARNING: These products can expose you to chemicals including carbon black (airborne and extracts), antimony trioxide, titanium dioxide, silica (crystalline), di(2-ethylhexyl) phthalate, ethylene thiourea, acrylonitrile, 1,3-butadiene, epichlorohydrin, toluenediisocyanate, tetrafluoroethylene, ethylbenzene, formaldehyde, furfuryl alcohol, glass fibers, methyl isobutyl ketone, nickel (metallic and compounds), lead and lead compounds which are known to the State of California to cause cancer; and 1,3-butadiene, epichlorohydrin, di(2-ethylhexyl)phthalate, di-isodecyl phthalate, ethylene thiourea, methyl isobutyl ketone, methanol, toluene, lead and lead compounds which are known to the State of California to cause birth defects and other reproductive harm. For more information go to www.P65Warnings.ca.gov.

10.4 Abbreviations

ACM	Polyacrylate Rubber	in.	Inch
AF	Air Force	IR	Isoprene Rubber
AFML	Air Force Material Laboratory	JAN	Joint Army-Navy
AMS	Aerospace Material Specification	JIC	Joint Industry Conference on Hydraulic Standards for Industrial Equipment
AN	(1) Army-Navy; (2) Air Force-Navy	K	Degrees Kelvin (Absolute) — (°C +273)
ANA	Air Force-Navy Aeronautical Bulletin	Max	Maximum
AND	Air Force-Navy Design	MIL	Military Specification
AQL	Acceptable Quality Level	Min	Minimum
ARP	Aerospace Recommended Practice	MS	Military Standard
AS	Aerospace Standard	MVQ	Silicone Rubber
ASTM	American Society for Testing and Materials	NAS	National Aerospace Standard (also National Aircraft Standards [older meaning])
atm	Atmosphere (atmospheric)	NASA	National Aeronautics and Space Administration
AU	Polyurethane Rubber	NBR	Nitrile or Buna-N Rubber
BR	Butadiene Rubber	No	Number
C or °C	Degrees Centigrade	NR	Natural Rubber
cc	Cubic centimeter	OD	Outside Diameter
C.G.S.	Centimeter-Gram-Second; system of units for length, mass, and time	psi	Pounds per square inch
CO	Epichlorohydrin Rubber	PVMQ	Phenyl Silicone Rubber
cpm	Cycles per minute	QPL	Military Qualified Products List
CR	Chloroprene (Neoprene)	R or °R	Degrees Rankine (Absolute) — (°F +460)
cs	Cross Section	Rad	Radius
CSM	Hypalon Rubber	RMA	Rubber Manufacturers Association
Dia	Diameter	RMS	Root-Mean-Square; average value of surface roughness measured in microinches
ECO	Epichlorohydrin Rubber	rpm	Revolutions per minute
EP, EPM	Ethylene-Propylene Rubber	SAE	Society of Automotive Engineers, Inc.
EPDM	Ethylene-Propylene Rubber	SBR	Styrene Butadiene Rubber
EU	Polyurethane Rubber	sfm	Surface Feet per minute
F or °F	Degrees Fahrenheit	Spec	Specification
FED	Federal Specification	T	Polysulfide Rubber
FKM	(also FPM) Fluorocarbon Rubber	Temp.	Temperature
F.P.S.	Foot-Pound-Second; system of units for length, weight and time	TFE/P	AFLAS
FVMQ	Fluorosilicone Rubber	USAF	United States Air Force
HNBR	Hydrogenated Nitrile Rubber	VMQ	Silicone Rubber
GRS	“Government Rubber Styrene”; now SBR	W	Width (seal cross section)
ID	Inside Diameter	WPAFB	Wright-Patterson Air Force Base
IIR	Butyl Rubber	XNBR	Carboxylated Nitrile Rubber

WARNING: These products can expose you to chemicals including carbon black (airborne and extracts), antimony trioxide, titanium dioxide, silica (crystalline), di(2-ethylhexyl) phthalate, ethylene thiourea, acrylonitrile, 1,3-butadiene, epichlorohydrin, toluenediisocyanate, tetrafluoroethylene, ethylbenzene, formaldehyde, furfuryl alcohol, glass fibers, methyl isobutyl ketone, nickel (metallic and compounds), lead and lead compounds which are known to the State of California to cause cancer; and 1,3-butadiene, epichlorohydrin, di(2-ethylhexyl)phthalate, di-isodecyl phthalate, ethylene thiourea, methyl isobutyl ketone, methanol, toluene, lead and lead compounds which are known to the State of California to cause birth defects and other reproductive harm. For more information go to www.P65Warnings.ca.gov.

10.5 Standard Shrinkage

All rubber materials shrink during molding, resulting in finished parts that are smaller than the mold cavity dimensions. “Standard” mold shrinkage is called “AN” shrinkage. Compounds that are manufactured from unusual formulations or polymers will have different shrinkage rates associated with them. Some materials shrink LESS than the standard (AN) nitrile would in the same mold. These materials have been given an arbitrary CLASS(-1) shrinkage designation. Still other materials have shrinkage rates that are greater than the standard (AN) shrink rate. These progressively larger shrinkage rates have been arbitrarily called CLASS I through CLASS VI.

Table 10-7 lists the shrinkage class for some of our more popular compounds. Table 10-8 lists all the possibilities for dimensions for Parker’s 2-xxx and 3-xxx series O-ring sizes depending upon the shrinkage of the material that is chosen.

In applications that require materials with shrinkage more or less than the standard (AN) rate, the O-ring gland dimensions may have to be modified to provide the desired squeeze. If the assembled inside diameter of the O-ring is fixed, a high-shrink compound will be stretched more than a standard material, and this will reduce the O-ring cross-section further. See Figure 3-3 to observe the effect of this stretch on the “W” Dimension. When O-rings of a high-shrink compound are required for use in standard (AN) or special dimensions, molds can be made to compensate for the shrinkage, but at special mold costs.

It should be noted that many factors affect the shrinkage of rubber compounds, including method (injection, compression, transfer), time, temperature, and/or pressure, to name a few. As new manufacturing techniques for O-rings are developed, there will be the possibility that shrinkage rates of our compounds will change (or shift) correspondingly. For this reason, consultation with the factory is imperative prior to specifying a particular Parker compound.

10.5.1 Procedure for O-Rings Molded of Compounds Having Non-Standard Shrinkage Rates

Determine the Finished Dimension and Tolerances as Follows:

2- and 3- Sizes

1. Locate the compound in Table 10-7 and note the shrinkage class listed.
2. Use this shrinkage class and the O-ring size number to find the dimensions and tolerances in Table 10-8.

Example: O-ring size 2-150, Compound S0355-75
 (1) Shrinkage Class IV (Table 10-7)
 (2) Dimensions and Tolerances
 2.816" ± .032" I.D. X .101" ± .004 W. (Table 10-8)

5- Sizes

1. Locate the compound in Table 10-7, and note the shrinkage class listed.
2. Find the standard AN dimensions and tolerances in Table 9-3. (If the I.D. is not known, refer to Table 9-4 first.)
3. Find the actual I.D. and cross-section by multiplying the standard I.D. and W. dimensions by the dimension factor from Table 10-10.
4. Find the I.D. tolerance by multiplying the standard I.D. by the tolerance factor from Table 10-10 and adding the result to the standard tolerance.
5. Find the actual cross-section tolerance in Table 10-9.

Example: O-ring Size 5-547, Compound S0355-75
 (1) Shrinkage Class III (Table 10-7)
 (2) Standard I.D. = 21.564 ± .100 W. = .139 ± .004
 (3) Actual I.D. = 21.564 X .984 = 21.219
 Actual W. = .139 X .984 = .137
 (4) I.D. Tolerance = 21.564 X .0036 + .100 = ± .178
 (5) W. Tolerance ± .005
 Actual Dimensions and Tolerance =
 21.219" ± .178" I.D. X .137" ± .005" W.

Note: Follow the procedure given for the 5-series to find dimensions and tolerances for special sizes for which standard shrinkage tooling exists.



WARNING: These products can expose you to chemicals including carbon black (airborne and extracts), antimony trioxide, titanium dioxide, silica (crystalline), di(2-ethylhexyl) phthalate, ethylene thiourea, acrylonitrile, 1,3-butadiene, epichlorohydrin, toluenediisocyanate, tetrafluoroethylene, ethylbenzene, formaldehyde, furfuryl alcohol, glass fibers, methyl isobutyl ketone, nickel (metallic and compounds), lead and lead compounds which are known to the State of California to cause cancer; and 1,3-butadiene, epichlorohydrin, di(2-ethylhexyl)phthalate, di-isodecyl phthalate, ethylene thiourea, methyl isobutyl ketone, methanol, toluene, lead and lead compounds which are known to the State of California to cause birth defects and other reproductive harm. For more information go to www.P65Warnings.ca.gov.

Compound Shrinkage Class

Compound Number	Shrinkage Class	Compound Number	Shrinkage Class	Compound Number	Shrinkage Class
47-071	AN	N0545-40	I	C0873-70	AN
N0103-70	AN	N0552-90	-1	V0884-75*	III
C0267-50	AN	C0557-70	AN	E0893-80	AN
N0287-70	AN	S0595-50	II	V0894-90*	II
N0299-50	I	N0602-70	AN	C0944-70	-1
N0304-75	AN	E0603-70	AN	N0951-75	AN
S0317-60	II	S0604-70	I	E0962-90	3
S0355-75	IV	B0612-70	I	E1028-70	AN
S0383-70	II	S0613-60	AN	N1090-85	I
N0406-60	I	S0614-80	AN	LM159-70	IV
S0455-70	V	P0642-70	2	C1124-70	AN
S0469-40	III	E0652-90	-1	LM158-60	IV
N0497-70	-1	E0667-70	I	LM160-80	II
N0506-65	I	N0674-70	AN	L1186-80	II
N0507-90	-1	V0680-70*	II	V1164-75*	III
N0508-75	-1	E0692-75	AN	V1226-75*	III
E0515-80	AN	V0709-90*	III	VM835-75	III
C0518-60	AN	E0740-75	AN	V1289-75	III
N0525-60	AN	V0747-75*	III		
E0540-80	AN	E0803-70	I		

* Fluorocarbon compounds that have CLASS III shrinkage are manufactured using special compensated molds that will give nominal dimensions equivalent to the corresponding standard AN size. However, the tolerance spread will be that of a CLASS III shrinkage material unless otherwise specified.

** Run on Compensated Tooling.

Note: The O-Ring Division is constantly developing new materials to solve customer needs. For the most up-to-date information, contact the O-Ring Division directly.

Table 10-7: Compound Shrinkage Class

WARNING: These products can expose you to chemicals including carbon black (airborne and extracts), antimony trioxide, titanium dioxide, silica (crystalline), di(2-ethylhexyl) phthalate, ethylene thiourea, acrylonitrile, 1,3-butadiene, epichlorohydrin, toluenediisocyanate, tetrafluoroethylene, ethylbenzene, formaldehyde, furfuryl alcohol, glass fibers, methyl isobutyl ketone, nickel (metallic and compounds), lead and lead compounds which are known to the State of California to cause cancer; and 1,3-butadiene, epichlorohydrin, di(2-ethylhexyl)phthalate, di-isodecyl phthalate, ethylene thiourea, methyl isobutyl ketone, methanol, toluene, lead and lead compounds which are known to the State of California to cause birth defects and other reproductive harm. For more information go to www.P65Warnings.ca.gov.

Dimensions From Standard Tooling

The following are the anticipated dimensions and tolerances for O-rings from compounds having various shrinkage rates when molded in standard tooling (tooling produced to allow for

the average or AN shrinkage rate). The shrinkage classes of a number of popular Parker Compounds are listed in Table 10-7.

Dimensions From Standard Tooling

Parker Size Number	Class -1				Class AN				Class I				Class II					
	ID	Tol ±	W	Tol ±	ID	Tol ±	W	Tol ±	ID	Tol ±	W	Tol ±	ID	Tol ±	W	Tol ±		
2-001	.029	.004	.040	.003	.029	.004	.040	.003	.029	.004	.040	.004	.029	.004	.040	.004		
2-002	.042	.004	.050		.042	.004	.050		.042	.004	.050		.042	.004	.049			
2-003	.056	.004	.060		.056	.004	.060		.056	.004	.060		.055	.004	.059			
2-004	.070	.005	.070		.070	.005	.070		.070	.005	.070		.069	.005	.069			
2-005	.102				.101				.100				.100					
2-006	.115				.114				.113				.113					
2-007	.146				.145				.144				.143					
2-008	.177				.176				.175				.174					
2-009	.209				.208				.207				.206	.005				
2-010	.240				.239				.238				.236	.006				
2-011	.303				.301				.299	↓			.298					
2-012	.366				.364				.362	.005			.360	↓				
2-013	.429	↓			.426	↓			.423	.006			.421	.006				
2-014	.492	.005			.489	.005			.486	.006			.484	.006				
2-015	.554	.007			.551	.007			.548	.008			.545	.008				
2-016	.618	.009			.614	.009			.610	.010			.607	.010				
2-017	.680	.009			.676	.009			.672	.010			.669	.011				
2-018	.743	.009			.739	.009			.735	.010			.731	.011				
2-019	.806	.009			.801	.009			.796	.010			.792	.011				
2-020	.869	.009			.864	.009			.859	.010			.854	.011				
2-021	.932	.009			.926	.009			.920	.010			.916	.011				
2-022	.995	.010			.989	.010			.983	.011			.978	.012				
2-023	1.057	.010			1.051	.010			1.045	.011			1.039	.013				
2-024	1.121	.010			1.114	.010			1.107	.011			1.102	.013				
2-025	1.183	.011			1.176	.011			1.169	.012			1.163	.014				
2-026	1.246	.011			1.239	.011			1.232	.012			1.225	.014				
2-027	1.309	.011			1.301	.011			1.293	.013			1.287	.014				
2-028	1.372	.013			1.364	.013			1.356	.015			1.349	.016				
2-029	1.498	.013			1.489	.013			1.480	.015			1.473	.017				
2-030	1.624	.013			1.614	.013			1.604	.015			1.596	.017				
2-031	1.749	.015			1.739	.015			1.729	.017			1.720	.019				
2-032	1.875	.015			1.864	.015			1.853	.017			1.843	.019				
2-033	2.001	.018			1.989	.018			1.977	.020			1.967	.023				
2-034	2.127	.018			2.114	.018			2.101	.021			2.091	.023				
2-035	2.252	.018			2.239	.018			2.226	.021			2.214	.023				
2-036	2.378	.018			2.364	.018			2.350	.021			2.338	.024				
2-037	2.504	.018			2.489	.018			2.474	.021			2.462	.024				
2-038	2.630	.020			2.614	.020			2.598	.023			2.585	.026				
2-039	2.755	.020			2.739	.020			2.723	.023			2.709	.027				
2-040	2.881	.020			2.864	.020			2.847	.023			2.832	.027				
2-041	3.007	.024			2.989	.024			2.971	.028			2.956	.031				
2-042	3.258	.024			3.239	.024			3.220	.028			3.203	.032				
2-043	3.510	.024			3.489	.024			3.468	.028			3.451	.032				
2-044	3.761	.027			3.739	.027			3.717	.031			3.698	.036				
2-045	4.013	.027			3.989	.027			3.965	.032			3.945	.037				
2-046	4.264	.030			4.239	.030			4.214	.035			4.192	.040				
2-047	4.516	.030			4.489	.030			4.462	.035			4.440	.041				
2-048	4.767	.030			4.739	.030			4.711	.036			4.687	.041				
2-049	5.019	.037		↓	4.989	.037			4.959	.043			4.934	.049				
2-050	5.270	.037	↓	.070	5.239	.037	↓	.070	↓	.043	↓	.070	↓	.050	↓	.069	↓	.004

Table 10-8: Dimensions From Standard Tooling

WARNING: These products can expose you to chemicals including carbon black (airborne and extracts), antimony trioxide, titanium dioxide, silica (crystalline), di(2-ethylhexyl) phthalate, ethylene thiourea, acrylonitrile, 1,3-butadiene, epichlorohydrin, toluenediisocyanate, tetrafluoroethylene, ethylbenzene, formaldehyde, furfuryl alcohol, glass fibers, methyl isobutyl ketone, nickel (metallic and compounds), lead and lead compounds which are known to the State of California to cause cancer; and 1,3-butadiene, epichlorohydrin, di(2-ethylhexyl)phthalate, di-isodecyl phthalate, ethylene thiourea, methyl isobutyl ketone, methanol, toluene, lead and lead compounds which are known to the State of California to cause birth defects and other reproductive harm. For more information go to www.P65Warnings.ca.gov.

Dimensions From Standard Tooling (Continued)

Parker Size Number	Class III				Class IV				Class V				Class VI			
	ID	Tol ±	W	Tol ±	ID	Tol ±	W	Tol ±	ID	Tol ±	W	Tol ±	ID	Tol ±	W	Tol ±
2-001	.029	.004	.039	.004	.028	.004	.039	.004	.028	.004	.039	.004	.028	.004	.039	.004
2-002	.041	.004	.049		.041	.004	.049		.041	.004	.049		.041	.004	.048	
2-003	.055	.004	.059		.055	.004	.059		.055	.004	.058		.054	.004	.058	
2-004	.069	.005	.069		.069	.005	.069		.068	.005	.068		.068	.006	.068	
2-005	.099	.005			.099	.005			.098	.006			.098	.006		
2-006	.112	.005			.112	.006			.111	.006			.110	.006		
2-007	.143	.006			.142	.006			.141	.006			.141	.006		
2-008	.173	.006			.172	.006			.171	.006			.171	.006		
2-009	.205	.006			.204	.006			.203	.006			.202	.006		
2-010	.235	.006			.234	.006			.233	.006			.232	.007		
2-011	.296	.006			.295	.006			.293	.007			.292	.007		
2-012	.358	.006			.356	.007			.355	.007			.353	.008		
2-013	.419	.007			.417	.007			.415	.008			.413	.008		
2-014	.481	.007			.479	.007			.476	.008			.474	.009		
2-015	.542	.009			.539	.010			.537	.010			.534	.011		
2-016	.604	.011			.601	.012			.598	.013			.595	.013		
2-017	.665	.011			.662	.012			.658	.013			.655	.014		
2-018	.727	.012			.723	.013			.720	.013			.716	.014		
2-019	.788	.012			.784	.013			.780	.014			.776	.015		
2-020	.850	.012			.846	.013			.842	.014			.837	.015		
2-021	.911	.012			.907	.013			.902	.015			.897	.016		
2-022	.973	.014			.968	.015			.963	.016			.958	.017		
2-023	1.034	.014			1.029	.015			1.024	.016			1.018	.018		
2-024	1.096	.014			1.091	.015			1.085	.017			1.079	.018		
2-025	1.157	.015			1.151	.017			1.145	.018			1.140	.019		
2-026	1.219	.015			1.213	.017			1.207	.018			1.201	.020		
2-027	1.280	.016			1.274	.017			1.267	.019			1.261	.020		
2-028	1.342	.018			1.335	.020			1.329	.021			1.322	.023		
2-029	1.465	.018			1.458	.020			1.450	.022			1.443	.024		
2-030	1.588	.019			1.580	.021			1.572	.023			1.564	.025		
2-031	1.711	.021			1.702	.023			1.694	.025			1.685	.028		
2-032	1.834	.022			1.825	.024			1.816	.026			1.806	.028		
2-033	1.957	.025			1.947	.028			1.937	.030			1.927	.032		
2-034	2.080	.026			2.070	.028			2.059	.031			2.048	.033		
2-035	2.203	.026			2.192	.029			2.181	.031			2.170	.034		
2-036	2.326	.027			2.314	.029			2.303	.032			2.291	.035		
2-037	2.449	.027			2.437	.030			2.424	.033			2.412	.036		
2-038	2.572	.029			2.559	.033			2.546	.036			2.533	.039		
2-039	2.695	.030			2.681	.033			2.668	.036			2.654	.040		
2-040	2.818	.030			2.804	.034			2.790	.037			2.775	.041		
2-041	2.941	.035			2.926	.038			2.911	.042			2.896	.046		
2-042	3.187	.036			3.171	.040			3.155	.043			3.139	.047		
2-043	3.433	.037			3.416	.041			3.398	.045			3.381	.049		
2-044	3.679	.040			3.660	.045			3.642	.049			3.623	.054		
2-045	3.925	.041			3.905	.046			3.885	.051			3.865	.056		
2-046	4.171	.045			4.150	.050			4.129	.055			4.108	.061		
2-047	4.417	.046			4.395	.052			4.372	.057			4.350	.062		
2-048	4.663	.047			4.639	.053			4.616	.058			4.592	.064		
2-049	4.909	.055			4.884	.061			4.859	.067			4.834	.073		
2-050	5.155	.056	.069	.004	5.129	.062	.069	.004	5.103	.068	.068	.004	5.077	.075	.068	.004

Table 10-8: Dimensions From Standard Tooling

WARNING: These products can expose you to chemicals including carbon black (airborne and extracts), antimony trioxide, titanium dioxide, silica (crystalline), di(2-ethylhexyl) phthalate, ethylene thiourea, acrylonitrile, 1,3-butadiene, epichlorohydrin, toluenediisocyanate, tetrafluoroethylene, ethylbenzene, formaldehyde, furfuryl alcohol, glass fibers, methyl isobutyl ketone, nickel (metallic and compounds), lead and lead compounds which are known to the State of California to cause cancer; and 1,3-butadiene, epichlorohydrin, di(2-ethylhexyl)phthalate, di-isodecyl phthalate, ethylene thiourea, methyl isobutyl ketone, methanol, toluene, lead and lead compounds which are known to the State of California to cause birth defects and other reproductive harm. For more information go to www.P65Warnings.ca.gov.

Dimensions From Standard Tooling (Continued)

Parker Size Number	Class -1				Class AN				Class I				Class II			
	ID	Tol ±	W	Tol ±	ID	Tol ±	W	Tol ±	ID	Tol ±	W	Tol ±	ID	Tol ±	W	Tol ±
2-102	.049	.005	.104	.003	.049	.005	.103	.003	.049	.005	.102	.004	.048	.005	.102	.004
2-103	.081				.081				.081				.080			
2-104	.113				.113				.111				.111			
2-105	.144				.143				.142				.141			
2-106	.175				.174				.173				.172			
2-107	.207				.206				.205				.204			
2-108	.238				.237				.236				.234	.006		
2-109	.301				.299				.297				.296	.006		
2-110	.364				.362				.360				.358	.006		
2-111	.427	↓			.424				.421	.006			.419	.006		
2-112	.490	.005			.487	↓			.484	.007			.482	.006		
2-113	.552	.007			.549	.007			.546	.008			.543	.008		
2-114	.616	.009			.612	.009			.608	.010			.605	.010		
2-115	.678	.009			.674	.009			.670	.010			.667	.011		
2-116	.741	.009			.737	.009			.733	.010			.729	.011		
2-117	.804	.010			.799	.010			.794	.011			.790	.012		
2-118	.867	.010			.862	.010			.857	.011			.853	.012		
2-119	.930	.010			.924	.010			.918	.011			.914	.012		
2-120	.993	.010			.987	.010			.981	.011			.976	.012		
2-121	1.055	.010			1.049	.010			1.043	.011			1.037	.013		
2-122	1.119	.010			1.112	.010			1.105	.011			1.100	.013		
2-123	1.181	.012			1.174	.012			1.167	.013			1.161	.015		
2-124	1.244	.012			1.237	.012			1.230	.013			1.223	.015		
2-125	1.307	.012			1.299	.012			1.291	.014			1.285	.015		
2-126	1.370	.012			1.362	.012			1.354	.014			1.347	.015		
2-127	1.433	.012			1.424	.012			1.415	.014			1.408	.015		
2-128	1.496	.012			1.487	.012			1.478	.014			1.471	.016		
2-129	1.558	.015			1.549	.015			1.540	.017			1.532	.019		
2-130	1.622	.015			1.612	.015			1.602	.017			1.594	.019		
2-131	1.684	.015			1.674	.015			1.664	.017			1.656	.019		
2-132	1.747	.015			1.737	.015			1.727	.017			1.718	.019		
2-133	1.810	.015			1.799	.015			1.788	.017			1.779	.019		
2-134	1.873	.015			1.862	.015			1.851	.017			1.842	.019		
2-135	1.937	.017			1.925	.017			1.913	.019			1.904	.022		
2-136	1.999	.017			1.987	.017			1.975	.019			1.965	.022		
2-137	2.062	.017			2.050	.017			2.038	.020			2.027	.022		
2-138	2.125	.017			2.112	.017			2.099	.020			2.089	.022		
2-139	2.188	.017			2.175	.017			2.162	.020			2.151	.022		
2-140	2.250	.017			2.237	.017			2.224	.020			2.212	.022		
2-141	2.314	.020			2.300	.020			2.286	.023			2.275	.026		
2-142	2.376	.020			2.362	.020			2.348	.023			2.336	.026		
2-143	2.440	.020			2.425	.020			2.410	.023			2.398	.026		
2-144	2.502	.020			2.487	.020			2.472	.023			2.460	.026		
2-145	2.565	.020			2.550	.020			2.535	.023			2.522	.026		
2-146	2.628	.020			2.612	.020			2.596	.023			2.583	.026		
2-147	2.691	.022			2.675	.022			2.659	.025			2.646	.028		
2-148	2.753	.022			2.737	.022			2.721	.025			2.707	.029		
2-149	2.817	.022			2.800	.022			2.783	.025			2.769	.029		
2-150	2.879	.022			2.862	.022			2.845	.025			2.831	.029		
2-151	3.005	.024			2.987	.024			2.969	.028			2.954	.031		
2-152	3.256	.024			3.237	.024			3.218	.028			3.201	.032		
2-153	3.508	.024			3.487	.024			3.466	.028			3.449	.032		
2-154	3.759	.028			3.737	.028			3.715	.032			3.696	.037		
2-155	4.011	.028	↓	↓	3.987	.028	↓	↓	3.963	.033	↓	↓	3.943	.038	↓	↓
2-156	4.262	.030	.104	.003	4.237	.030	.103	.003	4.212	.035	.102	.004	4.190	.040	.102	.004

Table 10-8: Dimensions From Standard Tooling

WARNING: These products can expose you to chemicals including carbon black (airborne and extracts), antimony trioxide, titanium dioxide, silica (crystalline), di(2-ethylhexyl) phthalate, ethylene thiourea, acrylonitrile, 1,3-butadiene, epichlorohydrin, toluenediisocyanate, tetrafluoroethylene, ethylbenzene, formaldehyde, furfuryl alcohol, glass fibers, methyl isobutyl ketone, nickel (metallic and compounds), lead and lead compounds which are known to the State of California to cause cancer; and 1,3-butadiene, epichlorohydrin, di(2-ethylhexyl)phthalate, di-isodecyl phthalate, ethylene thiourea, methyl isobutyl ketone, methanol, toluene, lead and lead compounds which are known to the State of California to cause birth defects and other reproductive harm. For more information go to www.P65Warnings.ca.gov.

Dimensions From Standard Tooling (Continued)

Parker Size Number	Class III				Class IV				Class V				Class VI			
	ID	Tol ±	W	Tol ±	ID	Tol ±	W	Tol ±	ID	Tol ±	W	Tol ±	ID	Tol ±	W	Tol ±
2-102	.048	.005	.101	.004	.048	.005	.101	.004	.048	.005	.100	.005	.047	.005	.100	.005
2-103	.080	.005			.079	.005			.079	.005			.078	.006		
2-104	.110	.005			.110	.006			.109	.006			.109	.006		
2-105	.141	.006			.140	.006			.139	.006			.139	.006		
2-106	.171	.006			.170	.006			.169	.006			.169	.006		
2-107	.203	.006			.202	.006			.201	.006			.200	.006		
2-108	.233	.006			.232	.006			.231	.006			.230	.007		
2-109	.294	.006			.293	.006			.291	.007			.290	.007		
2-110	.356	.006			.354	.007			.353	.007			.351	.008		
2-111	.417	.007			.415	.007			.413	.008			.411	.008		
2-112	.479	.007			.477	.007			.474	.008			.472	.009		
2-113	.540	.009			.537	.010			.535	.010			.532	.011		
2-114	.602	.011			.599	.012			.596	.013			.593	.013		
2-115	.663	.011			.660	.012			.656	.013			.653	.014		
2-116	.725	.012			.722	.013			.718	.013			.714	.014		
2-117	.786	.013			.782	.014			.778	.015			.774	.016		
2-118	.848	.013			.844	.014			.840	.015			.835	.016		
2-119	.909	.013			.905	.014			.900	.016			.895	.017		
2-120	.971	.014			.966	.015			.961	.016			.956	.017		
2-121	1.032	.014			1.027	.015			1.022	.016			1.016	.018		
2-122	1.094	.014			1.089	.015			1.083	.017			1.078	.018		
2-123	1.155	.016			1.149	.018			1.143	.019			1.138	.020		
2-124	1.217	.016			1.211	.018			1.205	.019			1.199	.021		
2-125	1.278	.017			1.272	.018			1.265	.020			1.259	.021		
2-126	1.340	.017			1.333	.019			1.327	.020			1.320	.022		
2-127	1.401	.017			1.394	.019			1.387	.021			1.380	.022		
2-128	1.463	.017			1.456	.019			1.448	.021			1.441	.023		
2-129	1.524	.021			1.516	.022			1.509	.024			1.501	.026		
2-130	1.586	.021			1.578	.023			1.570	.025			1.562	.027		
2-131	1.647	.021			1.639	.023			1.630	.025			1.622	.027		
2-132	1.709	.021			1.701	.023			1.692	.025			1.683	.028		
2-133	1.770	.021			1.761	.024			1.752	.026			1.743	.028		
2-134	1.832	.022			1.823	.024			1.814	.026			1.804	.028		
2-135	1.894	.024			1.885	.026			1.875	.029			1.865	.031		
2-136	1.955	.024			1.945	.027			1.935	.029			1.925	.031		
2-137	2.017	.024			2.007	.027			1.997	.029			1.986	.032		
2-138	2.078	.025			2.068	.027			2.057	.030			2.047	.032		
2-139	2.140	.025			2.129	.027			2.118	.030			2.108	.033		
2-140	2.201	.025			2.190	.028			2.179	.030			2.168	.033		
2-141	2.263	.028			2.252	.031			2.240	.034			2.229	.037		
2-142	2.324	.029			2.312	.031			2.301	.034			2.289	.037		
2-143	2.386	.029			2.374	.032			2.362	.035			2.350	.037		
2-144	2.447	.029			2.435	.032			2.422	.035			2.410	.038		
2-145	2.509	.029			2.496	.032			2.484	.035			2.471	.038		
2-146	2.570	.029			2.557	.033			2.544	.036			2.531	.039		
2-147	2.632	.032			2.619	.035			2.605	.038			2.592	.041		
2-148	2.693	.032			2.680	.035			2.666	.038			2.652	.042		
2-149	2.755	.032			2.741	.035			2.727	.039			2.713	.042		
2-150	2.816	.032			2.802	.036			2.788	.039			2.773	.043		
2-151	2.939	.035			2.924	.038			2.909	.042			2.894	.046		
2-152	3.185	.036			3.169	.040			3.153	.043			3.137	.047		
2-153	3.431	.037			3.414	.041			3.396	.045			3.379	.049		
2-154	3.677	.041			3.659	.046			3.640	.050			3.621	.055		
2-155	3.923	.042			3.903	.047			3.883	.052			3.863	.057		
2-156	4.169	.045	.101	.004	4.148	.050	.101	.004	4.127	.055	.100	.005	4.106	.061	.100	.005

Table 10-8: Dimensions From Standard Tooling

WARNING: These products can expose you to chemicals including carbon black (airborne and extracts), antimony trioxide, titanium dioxide, silica (crystalline), di(2-ethylhexyl) phthalate, ethylene thiourea, acrylonitrile, 1,3-butadiene, epichlorohydrin, toluenediisocyanate, tetrafluoroethylene, ethylbenzene, formaldehyde, furfuryl alcohol, glass fibers, methyl isobutyl ketone, nickel (metallic and compounds), lead and lead compounds which are known to the State of California to cause cancer; and 1,3-butadiene, epichlorohydrin, di(2-ethylhexyl)phthalate, di-isodecyl phthalate, ethylene thiourea, methyl isobutyl ketone, methanol, toluene, lead and lead compounds which are known to the State of California to cause birth defects and other reproductive harm. For more information go to www.P65Warnings.ca.gov.

Dimensions From Standard Tooling (Continued)

Parker Size Number	Class -1				Class AN				Class I				Class II			
	ID	Tol ±	W	Tol ±	ID	Tol ±	W	Tol ±	ID	Tol ±	W	Tol ±	ID	Tol ±	W	Tol ±
2-157	4.514	.030	.104	.003	4.487	.030	.103	.003	4.460	.035	.102	.004	4.438	.041	.102	.004
2-158	4.765	.030			4.737	.030			4.709	.036			4.685	.041		
2-159	5.017	.035			4.987	.035			4.957	.041			4.932	.047		
2-160	5.268	.035			5.237	.035			5.206	.041			5.179	.048		
2-161	5.520	.035			5.487	.035			5.454	.042			5.427	.048		
2-162	5.771	.035			5.737	.035			5.703	.042			5.674	.049		
2-163	6.023	.035			5.987	.035			5.951	.042			5.921	.049		
2-164	6.274	.040			6.237	.040			6.200	.047			6.168	.055		
2-165	6.526	.040			6.487	.040			6.448	.048			6.416	.056		
2-166	6.777	.040			6.737	.040			6.697	.048			6.663	.056		
2-167	7.029	.040			6.987	.040			6.945	.048			6.910	.057		
2-168	7.280	.045			7.237	.045			7.194	.054			7.157	.062		
2-169	7.532	.045			7.487	.045			7.442	.054			7.405	.063		
2-170	7.783	.045			7.737	.045			7.691	.054			7.652	.064		
2-171	8.035	.045			7.987	.045			7.939	.055			7.899	.064		
2-172	8.286	.050			8.237	.050			8.188	.060			8.146	.070		
2-173	8.538	.050			8.487	.050			8.436	.060			8.394	.070		
2-174	8.789	.050			8.737	.050			8.685	.060			8.641	.071		
2-175	9.041	.050			8.987	.050			8.933	.061			8.888	.072		
2-176	8.292	.055			9.237	.055			9.182	.066			9.135	.077		
2-177	9.544	.055			9.487	.055			9.430	.066			9.383	.078		
2-178	9.795	.055			9.737	.055			9.679	.067			9.630	.078		
2-201	.172	.005	.140	.004	.171	.005	.139	.004	.170	.005	.138	.005	.169	.005	.137	.005
2-202	.235	.005			.234	.005			.233	.005			.231	.006		
2-203	.298	.005			.296	.005			.294	.005			.293	.006		
2-204	.361	.005			.359	.005			.357	.005			.355	.006		
2-205	.424	.005			.421	.005			.418	.006			.416	.006		
2-206	.487	.005			.484	.005			.481	.006			.479	.007		
2-207	.549	.007			.546	.007			.543	.008			.540	.008		
2-208	.613	.009			.609	.009			.605	.010			.602	.010		
2-209	.675	.009			.671	.009			.667	.010			.664	.011		
2-210	.738	.010			.734	.010			.730	.011			.726	.012		
2-211	.801	.010			.796	.010			.791	.011			.787	.012		
2-212	.864	.010			.859	.010			.854	.011			.850	.012		
2-213	.927	.010			.921	.010			.915	.011			.911	.012		
2-214	.990	.010			.984	.010			.978	.011			.973	.012		
2-215	1.052	.010			1.046	.010			1.040	.011			1.034	.013		
2-216	1.116	.012			1.109	.012			1.102	.013			1.097	.015		
2-217	1.178	.012			1.171	.012			1.164	.013			1.158	.015		
2-218	1.241	.012			1.234	.012			1.227	.013			1.220	.015		
2-219	1.304	.012			1.296	.012			1.288	.014			1.282	.015		
2-220	1.367	.012			1.359	.012			1.351	.014			1.344	.015		
2-221	1.430	.012			1.421	.012			1.412	.014			1.405	.015		
2-222	1.493	.015			1.484	.015			1.475	.017			1.468	.019		
2-223	1.619	.015			1.609	.015			1.599	.017			1.591	.019		
2-224	1.744	.015			1.734	.015			1.724	.017			1.715	.019		
2-225	1.870	.018			1.859	.018			1.848	.020			1.839	.022		
2-226	1.996	.018			1.984	.018			1.972	.020			1.962	.023		
2-227	2.122	.018			2.109	.018			2.096	.021			2.086	.023		
2-228	2.247	.020			2.234	.020			2.221	.023			2.209	.025		
2-229	2.373	.020			2.359	.020			2.345	.023			2.333	.026		
2-230	2.499	.020			2.484	.020			2.469	.023			2.457	.026		
2-231	2.625	.020			2.609	.020			2.593	.023			2.580	.026		
2-232	2.750	.024			2.734	.024			2.718	.027			2.704	.031		
2-233	2.876	.024	.140	.004	2.859	.024	.139	.004	2.842	.027	.138	.005	2.828	.031	.137	.005

Table 10-8: Dimensions From Standard Tooling

WARNING: These products can expose you to chemicals including carbon black (airborne and extracts), antimony trioxide, titanium dioxide, silica (crystalline), di(2-ethylhexyl) phthalate, ethylene thiourea, acrylonitrile, 1,3-butadiene, epichlorohydrin, toluenediisocyanate, tetrafluoroethylene, ethylbenzene, formaldehyde, furfuryl alcohol, glass fibers, methyl isobutyl ketone, nickel (metallic and compounds), lead and lead compounds which are known to the State of California to cause cancer; and 1,3-butadiene, epichlorohydrin, di(2-ethylhexyl)phthalate, di-isodecyl phthalate, ethylene thiourea, methyl isobutyl ketone, methanol, toluene, lead and lead compounds which are known to the State of California to cause birth defects and other reproductive harm. For more information go to www.P65Warnings.ca.gov.

Dimensions From Standard Tooling (Continued)

Parker Size Number	Class III				Class IV				Class V				Class VI			
	ID	Tol ±	W	Tol ±	ID	Tol ±	W	Tol ±	ID	Tol ±	W	Tol ±	ID	Tol ±	W	Tol ±
2-157	4.415	.046	.101	.004	4.393	.052	.101	.004	4.370	.057	.100	.005	4.348	.062	.100	.005
2-158	4.661	.047			4.638	.053			4.614	.058			4.590	.064		
2-159	4.907	.053			4.882	.059			4.857	.065			4.832	.071		
2-160	5.153	.054			5.127	.060			5.101	.066			5.075	.073		
2-161	5.399	.055			5.372	.061			5.344	.068			5.317	.075		
2-162	5.645	.056			5.617	.063			5.588	.069			5.559	.076		
2-163	5.891	.057			5.861	.064			5.831	.071			5.801	.078		
2-164	6.137	.062			6.106	.070			6.075	.077			6.044	.085		
2-165	6.383	.063			6.351	.071			6.318	.079			6.286	.087		
2-166	6.629	.064			6.596	.072			6.562	.080			6.528	.089		
2-167	6.875	.065			6.840	.074			6.805	.082			6.770	.090		
2-168	7.121	.071			7.085	.080			7.049	.088			7.013	.097		
2-169	7.367	.072			7.330	.081			7.292	.090			7.255	.099		
2-170	7.613	.073			7.575	.082			7.536	.091			7.497	.101		
2-171	7.859	.074			7.819	.083			7.779	.093			7.739	.103		
2-172	8.105	.080			8.064	.090			8.023	.099			7.982	.109		
2-173	8.351	.081			8.309	.091			8.266	.101			8.224	.111		
2-174	8.597	.081			8.554	.092			8.510	.102			8.466	.113		
2-175	8.843	.082			8.798	.093			8.753	.104			8.708	.115		
2-176	9.089	.088			9.043	.099			8.997	.110			8.951	.122		
2-177	9.335	.089			9.288	.101			9.240	.112			9.193	.123		
2-178	9.581	.090			9.533	.102			9.484	.113			9.435	.125		
2-201	.168	.006	.137	.005	.167	.006	.136	.006	.167	.006	.135	.006	.166	.006	.135	.006
2-202	.230	.006			.229	.006			.228	.006			.227	.007		
2-203	.291	.006			.290	.006			.288	.007			.287	.007		
2-204	.353	.006			.351	.007			.350	.007			.348	.008		
2-205	.414	.007			.412	.007			.410	.008			.408	.008		
2-206	.476	.007			.474	.007			.471	.008			.469	.008		
2-207	.537	.009			.535	.010			.532	.010			.529	.011		
2-208	.599	.011			.596	.012			.593	.013			.590	.013		
2-209	.660	.011			.657	.012			.654	.013			.650	.014		
2-210	.722	.013			.719	.014			.715	.014			.711	.015		
2-211	.783	.013			.779	.014			.775	.015			.771	.016		
2-212	.845	.013			.841	.014			.837	.015			.832	.016		
2-213	.906	.013			.902	.014			.897	.016			.892	.017		
2-214	.968	.014			.963	.015			.958	.016			.953	.017		
2-215	1.029	.014			1.024	.015			1.019	.016			1.014	.018		
2-216	1.091	.016			1.086	.017			1.080	.019			1.075	.020		
2-217	1.152	.016			1.146	.018			1.141	.019			1.135	.020		
2-218	1.214	.016			1.208	.018			1.202	.019			1.196	.021		
2-219	1.275	.017			1.269	.018			1.262	.020			1.256	.021		
2-220	1.337	.017			1.330	.019			1.324	.020			1.317	.022		
2-221	1.398	.017			1.391	.019			1.384	.021			1.377	.022		
2-222	1.460	.020			1.453	.022			1.445	.024			1.438	.026		
2-223	1.583	.021			1.575	.023			1.567	.025			1.559	.027		
2-224	1.706	.021			1.698	.023			1.689	.025			1.680	.027		
2-225	1.829	.025			1.820	.027			1.811	.029			1.801	.031		
2-226	1.952	.025			1.942	.028			1.932	.030			1.922	.032		
2-227	2.075	.026			2.065	.028			2.054	.031			2.044	.033		
2-228	2.198	.028			2.187	.031			2.176	.033			2.165	.036		
2-229	2.321	.028			2.309	.031			2.298	.034			2.286	.037		
2-230	2.444	.029			2.432	.032			2.419	.035			2.407	.038		
2-231	2.567	.029			2.554	.033			2.541	.036			2.528	.039		
2-232	2.690	.034			2.677	.037			2.663	.040			2.649	.044		
2-233	2.813	.034	.137	.005	2.799	.038	.136	.006	2.785	.041	.135	.006	2.770	.045	.135	.006

Table 10-8: Dimensions From Standard Tooling

WARNING: These products can expose you to chemicals including carbon black (airborne and extracts), antimony trioxide, titanium dioxide, silica (crystalline), di(2-ethylhexyl) phthalate, ethylene thiourea, acrylonitrile, 1,3-butadiene, epichlorohydrin, toluenediisocyanate, tetrafluoroethylene, ethylbenzene, formaldehyde, furfuryl alcohol, glass fibers, methyl isobutyl ketone, nickel (metallic and compounds), lead and lead compounds which are known to the State of California to cause cancer; and 1,3-butadiene, epichlorohydrin, di(2-ethylhexyl)phthalate, di-isodecyl phthalate, ethylene thiourea, methyl isobutyl ketone, methanol, toluene, lead and lead compounds which are known to the State of California to cause birth defects and other reproductive harm. For more information go to www.P65Warnings.ca.gov.

Dimensions From Standard Tooling (Continued)

Parker Size Number	Class -1				Class AN				Class I				Class II			
	ID	Tol ±	W	Tol ±	ID	Tol ±	W	Tol ±	ID	Tol ±	W	Tol ±	ID	Tol ±	W	Tol ±
2-234	3.002	.024	.140	.004	2.984	.024	.139	.004	2.966	.028	.138	.005	2.951	.031	.137	.005
2-235	3.128	.024			3.109	.024			3.090	.028			3.075	.031		
2-236	3.253	.024			3.234	.024			3.215	.028			3.198	.032		
2-237	3.379	.024			3.359	.024			3.339	.028			3.322	.032		
2-238	3.505	.024			3.484	.024			3.463	.028			3.446	.032		
2-239	3.631	.028			3.609	.028			3.587	.032			3.569	.037		
2-240	3.756	.028			3.734	.028			3.712	.032			3.693	.037		
2-241	3.882	.028			3.859	.028			3.836	.033			3.817	.037		
2-242	4.008	.028			3.984	.028			3.960	.033			3.940	.038		
2-243	4.134	.028			4.109	.028			4.084	.033			4.064	.038		
2-244	4.259	.030			4.234	.030			4.209	.035			4.187	.040		
2-245	4.385	.030			4.359	.030			4.333	.035			4.311	.040		
2-246	4.511	.030			4.484	.030			4.457	.035			4.435	.041		
2-247	4.637	.030			4.609	.030			4.581	.036			4.558	.041		
2-248	4.762	.030			4.734	.030			4.706	.036			4.682	.041		
2-249	4.888	.035			4.859	.035			4.830	.041			4.806	.047		
2-250	5.014	.035			4.984	.035			4.954	.041			4.929	.047		
2-251	5.140	.035			5.109	.035			5.078	.041			5.053	.047		
2-252	5.265	.035			5.234	.035			5.203	.041			5.176	.048		
2-253	5.391	.035			5.359	.035			5.327	.041			5.300	.048		
2-254	5.517	.035			5.484	.035			5.451	.042			5.424	.048		
2-255	5.643	.035			5.609	.035			5.575	.042			5.547	.048		
2-256	5.768	.035			5.734	.035			5.700	.042			5.671	.049		
2-257	5.894	.035			5.859	.035			5.824	.042			5.795	.049		
2-258	6.020	.035			5.984	.035			5.948	.042			5.918	.049		
2-259	6.271	.040			6.234	.040			6.197	.047			6.165	.055		
2-260	6.523	.040			6.484	.040			6.445	.048			6.413	.056		
2-261	6.774	.040			6.734	.040			6.694	.048			6.660	.056		
2-262	7.026	.040			6.984	.040			6.942	.048			6.907	.057		
2-263	7.277	.045			7.234	.045			7.191	.054			7.154	.062		
2-264	7.529	.045			7.484	.045			7.439	.054			7.402	.063		
2-265	7.780	.045			7.734	.045			7.688	.054			7.649	.064		
2-266	8.032	.045			7.984	.045			7.936	.055			7.896	.064		
2-267	8.283	.050			8.234	.050			8.185	.060			8.143	.070		
2-268	8.535	.050			8.484	.050			8.433	.060			8.391	.070		
2-269	8.786	.050			8.734	.050			8.682	.060			8.638	.071		
2-270	9.038	.050			8.984	.050			8.930	.061			8.885	.072		
2-271	9.289	.055			9.234	.055			9.179	.066			9.132	.077		
2-272	9.541	.055			9.484	.055			9.427	.066			9.380	.078		
2-273	9.792	.055			9.734	.055			9.676	.067			9.627	.078		
2-274	10.044	.055			9.984	.055			9.924	.067			9.874	.079		
2-275	10.547	.055			10.484	.055			10.421	.068			10.369	.080		
2-276	11.050	.065			10.984	.065			10.918	.078			10.863	.091		
2-277	11.553	.065			11.484	.065			11.415	.079			11.358	.093		
2-278	12.056	.065			11.984	.065			11.912	.079			11.852	.094		
2-279	13.062	.065			12.984	.065			12.906	.081			12.841	.096		
2-280	14.068	.065			13.984	.065			13.900	.082			13.830	.099		
2-281	15.074	.065			14.984	.065			14.894	.083			14.819	.101		
2-282	16.051	.075			15.955	.075			15.859	.094			15.779	.113		
2-283	17.057	.080			16.955	.080			16.853	.100			16.768	.121		
2-284	18.063	.085	↓	↓	17.955	.085	↓	↓	17.847	.107	↓	↓	17.757	.128	↓	↓
2-309	.414	.005	.211	.005	.412	.005	.210	.005	.410	.005	.209	.006	.407	.006	.208	.007
2-310	.478	.005	↓	↓	.475	.005	↓	↓	.472	.006	↓	↓	.470	.006	↓	↓
2-311	.540	.007	↓	↓	.537	.007	↓	↓	.534	.008	↓	↓	.531	.008	↓	↓
2-312	.604	.009	.211	.005	.600	.009	.210	.005	.596	.010	.209	.006	.593	.010	.208	.007

Table 10-8: Dimensions From Standard Tooling

WARNING: These products can expose you to chemicals including carbon black (airborne and extracts), antimony trioxide, titanium dioxide, silica (crystalline), di(2-ethylhexyl) phthalate, ethylene thiourea, acrylonitrile, 1,3-butadiene, epichlorohydrin, toluenediisocyanate, tetrafluoroethylene, ethylbenzene, formaldehyde, furfuryl alcohol, glass fibers, methyl isobutyl ketone, nickel (metallic and compounds), lead and lead compounds which are known to the State of California to cause cancer; and 1,3-butadiene, epichlorohydrin, di(2-ethylhexyl)phthalate, di-isodecyl phthalate, ethylene thiourea, methyl isobutyl ketone, methanol, toluene, lead and lead compounds which are known to the State of California to cause birth defects and other reproductive harm. For more information go to www.P65Warnings.ca.gov.

Dimensions From Standard Tooling (Continued)

Parker Size Number	Class III				Class IV				Class V				Class VI			
	ID	Tol ±	W	Tol ±	ID	Tol ±	W	Tol ±	ID	Tol ±	W	Tol ±	ID	Tol ±	W	Tol ±
2-234	2.936	.035	.137	.005	2.921	.038	.136	.006	2.906	.042	.135	.006	2.891	.045	.135	.006
2-235	3.059	.035			3.044	.039			3.028	.043			3.013	.046		
2-236	3.182	.036			3.166	.040			3.150	.043			3.134	.047		
2-237	3.305	.036			3.288	.040			3.272	.044			3.255	.048		
2-238	3.428	.037			3.411	.041			3.393	.045			3.376	.049		
2-239	3.551	.041			3.533	.045			3.515	.050			3.497	.054		
2-240	3.674	.041			3.656	.046			3.637	.050			3.618	.055		
2-241	3.797	.042			3.778	.047			3.759	.051			3.739	.056		
2-242	3.920	.042			3.900	.047			3.880	.052			3.860	.057		
2-243	4.043	.043			4.023	.048			4.002	.053			3.982	.058		
2-244	4.166	.045			4.145	.050			4.124	.055			4.103	.060		
2-245	4.289	.046			4.267	.051			4.246	.056			4.224	.061		
2-246	4.412	.046			4.390	.052			4.367	.057			4.345	.062		
2-247	4.535	.047			4.512	.052			4.489	.058			4.466	.063		
2-248	4.658	.047			4.635	.053			4.611	.058			4.587	.064		
2-249	4.781	.052			4.757	.058			4.733	.064			4.708	.070		
2-250	4.904	.053			4.879	.059			4.854	.065			4.829	.071		
2-251	5.027	.053			5.002	.060			4.976	.066			4.951	.072		
2-252	5.150	.054			5.124	.060			5.098	.066			5.072	.073		
2-253	5.273	.054			5.246	.061			5.220	.067			5.193	.074		
2-254	5.396	.055			5.369	.061			5.341	.068			5.314	.074		
2-255	5.519	.055			5.491	.062			5.463	.069			5.435	.075		
2-256	5.642	.056			5.614	.063			5.585	.069			5.556	.076		
2-257	5.765	.056			5.736	.063			5.707	.070			5.677	.077		
2-258	5.888	.057			5.858	.064			5.828	.071			5.798	.078		
2-259	6.134	.062			6.103	.070			6.072	.077			6.041	.085		
2-260	6.380	.063			6.348	.071			6.315	.079			6.283	.087		
2-261	6.626	.064			6.593	.072			6.559	.080			6.525	.088		
2-262	6.872	.065			6.837	.074			6.802	.082			6.767	.090		
2-263	7.118	.071			7.082	.080			7.046	.088			7.010	.097		
2-264	7.364	.072			7.327	.081			7.289	.090			7.252	.099		
2-265	7.610	.073			7.572	.082			7.533	.091			7.494	.101		
2-266	7.856	.074			7.816	.083			7.776	.093			7.736	.102		
2-267	8.102	.080			8.061	.090			8.020	.099			7.979	.109		
2-268	8.348	.081			8.306	.091			8.263	.101			8.221	.111		
2-269	8.594	.081			8.551	.092			8.507	.102			8.463	.113		
2-270	8.840	.082			8.795	.093			8.750	.104			8.705	.115		
2-271	9.086	.088			9.040	.099			8.994	.110			8.948	.121		
2-272	9.332	.089			9.285	.101			9.237	.112			9.190	.123		
2-273	9.578	.090			9.530	.102			9.481	.113			9.432	.125		
2-274	9.824	.091			9.774	.103			9.724	.115			9.674	.127		
2-275	10.316	.093			10.264	.105			10.211	.118			10.159	.130		
2-276	10.808	.105			10.753	.118			10.698	.131			10.643	.144		
2-277	11.300	.106			11.243	.120			11.185	.134			11.128	.148		
2-278	11.792	.108			11.732	.123			11.672	.137			11.612	.151		
2-279	12.776	.112			12.711	.127			12.646	.143			12.581	.158		
2-280	13.760	.115			13.690	.132			13.620	.149			13.550	.166		
2-281	14.744	.119			14.669	.137			14.594	.155			14.519	.173		
2-282	15.700	.132			15.620	.152			15.540	.171			15.460	.190		
2-283	16.684	.141			16.599	.161			16.514	.182			16.429	.202		
2-284	17.668	.150	↓	↓	17.578	.171	↓	↓	17.488	.193	↓	↓	17.398	.214	↓	↓
2-309	.405	.006	.207	.007	.403	.007	.206	.007	.401	.007	.205	.008	.399	.008	.203	.008
2-310	.467	.007	↓	↓	.465	.007	↓	↓	.463	.008	↓	↓	.460	.008	↓	↓
2-311	.528	.009	↓	↓	.526	.010	↓	↓	.523	.010	↓	↓	.520	.011	↓	↓
2-312	.590	.011	.207	.007	.587	.012	.206	.007	.584	.013	.205	.008	.581	.013	.203	.008

Table 10-8: Dimensions From Standard Tooling

WARNING: These products can expose you to chemicals including carbon black (airborne and extracts), antimony trioxide, titanium dioxide, silica (crystalline), di(2-ethylhexyl) phthalate, ethylene thiourea, acrylonitrile, 1,3-butadiene, epichlorohydrin, toluenediisocyanate, tetrafluoroethylene, ethylbenzene, formaldehyde, furfuryl alcohol, glass fibers, methyl isobutyl ketone, nickel (metallic and compounds), lead and lead compounds which are known to the State of California to cause cancer; and 1,3-butadiene, epichlorohydrin, di(2-ethylhexyl)phthalate, di-isodecyl phthalate, ethylene thiourea, methyl isobutyl ketone, methanol, toluene, lead and lead compounds which are known to the State of California to cause birth defects and other reproductive harm. For more information go to www.P65Warnings.ca.gov.

Dimensions From Standard Tooling (Continued)

Parker Size Number	Class -1				Class AN				Class I				Class II			
	ID	Tol ±	W	Tol ±	ID	Tol ±	W	Tol ±	ID	Tol ±	W	Tol ±	ID	Tol ±	W	Tol ±
2-313	.666	.009	.211	.005	.662	.009	.210	.005	.658	.010	.209	.006	.655	.011	.208	.007
2-314	.729	.010			.725	.010			.721	.011			.717	.012		
2-315	.792	.010			.787	.010			.782	.011			.778	.012		
2-316	.855	.010			.850	.010			.845	.011			.841	.012		
2-317	.917	.010			.912	.010			.907	.011			.902	.012		
2-318	.981	.010			.975	.010			.969	.011			.964	.012		
2-319	1.043	.010			1.037	.010			1.031	.011			1.026	.012		
2-320	1.107	.012			1.100	.012			1.093	.013			1.088	.015		
2-321	1.169	.012			1.162	.012			1.155	.013			1.149	.015		
2-322	1.232	.012			1.225	.012			1.218	.013			1.212	.015		
2-323	1.295	.012			1.287	.012			1.279	.014			1.273	.015		
2-324	1.358	.012			1.350	.012			1.342	.014			1.335	.015		
2-325	1.484	.015			1.475	.015			1.466	.017			1.459	.019		
2-326	1.610	.015			1.600	.015			1.590	.017			1.582	.019		
2-327	1.735	.015			1.725	.015			1.715	.017			1.706	.019		
2-328	1.861	.015			1.850	.015			1.839	.017			1.830	.019		
2-329	1.987	.018			1.975	.018			1.963	.020			1.953	.023		
2-330	2.113	.018			2.100	.018			2.087	.021			2.077	.023		
2-331	2.238	.018			2.225	.018			2.212	.021			2.201	.023		
2-332	2.364	.018			2.350	.018			2.336	.021			2.324	.024		
2-333	2.490	.020			2.475	.020			2.460	.023			2.448	.026		
2-334	2.616	.020			2.600	.020			2.584	.023			2.571	.026		
2-335	2.741	.020			2.725	.020			2.709	.023			2.695	.027		
2-336	2.867	.020			2.850	.020			2.833	.023			2.819	.027		
2-337	2.993	.024			2.975	.024			2.957	.028			2.942	.031		
2-338	3.119	.024			3.100	.024			3.081	.028			3.066	.031		
2-339	3.244	.024			3.225	.024			3.206	.028			3.190	.032		
2-340	3.370	.024			3.350	.024			3.330	.028			3.313	.032		
2-341	3.496	.024			3.475	.024			3.454	.028			3.437	.032		
2-342	3.622	.028			3.600	.028			3.578	.032			3.560	.037		
2-343	3.747	.028			3.725	.028			3.703	.032			3.684	.037		
2-344	3.873	.028			3.850	.028			3.827	.033			3.808	.037		
2-345	3.999	.028			3.975	.028			3.951	.033			3.931	.038		
2-346	4.125	.028			4.100	.028			4.075	.033			4.055	.038		
2-347	4.250	.030			4.225	.030			4.200	.035			4.179	.040		
2-348	4.376	.030			4.350	.030			4.324	.035			4.302	.040		
2-349	4.502	.030			4.475	.030			4.448	.035			4.426	.041		
2-350	4.628	.030			4.600	.030			4.572	.036			4.549	.041		
2-351	4.753	.030			4.725	.030			4.697	.036			4.673	.041		
2-352	4.879	.030			4.850	.030			4.821	.036			4.797	.042		
2-353	5.005	.037			4.975	.037			4.945	.043			4.920	.049		
2-354	5.131	.037			5.100	.037			5.069	.043			5.044	.049		
2-355	5.256	.037			5.225	.037			5.194	.043			5.168	.050		
2-356	5.382	.037			5.350	.037			5.318	.043			5.291	.050		
2-357	5.508	.037			5.475	.037			5.442	.044			5.415	.050		
2-358	5.634	.037			5.600	.037			5.566	.044			5.538	.050		
2-359	5.759	.037			5.725	.037			5.691	.044			5.662	.051		
2-360	5.885	.037			5.850	.037			5.815	.044			5.786	.051		
2-361	6.011	.037			5.975	.037			5.939	.044			5.909	.051		
2-362	6.262	.040			6.225	.040			6.188	.047			6.157	.055		
2-363	6.514	.040			6.475	.040			6.436	.048			6.404	.056		
2-364	6.765	.040			6.725	.040			6.685	.048			6.651	.056		
2-365	7.017	.040			6.975	.040			6.933	.048			6.898	.057		
2-366	7.268	.045			7.225	.045			7.182	.054			7.146	.062		
2-367	7.520	.045	.211	.005	7.475	.045	.210	.005	7.430	.054	.209	.006	7.393	.063	.208	.007

Table 10-8: Dimensions From Standard Tooling

WARNING: These products can expose you to chemicals including carbon black (airborne and extracts), antimony trioxide, titanium dioxide, silica (crystalline), di(2-ethylhexyl) phthalate, ethylene thiourea, acrylonitrile, 1,3-butadiene, epichlorohydrin, toluenediisocyanate, tetrafluoroethylene, ethylbenzene, formaldehyde, furfuryl alcohol, glass fibers, methyl isobutyl ketone, nickel (metallic and compounds), lead and lead compounds which are known to the State of California to cause cancer; and 1,3-butadiene, epichlorohydrin, di(2-ethylhexyl)phthalate, di-isodecyl phthalate, ethylene thiourea, methyl isobutyl ketone, methanol, toluene, lead and lead compounds which are known to the State of California to cause birth defects and other reproductive harm. For more information go to www.P65Warnings.ca.gov.

Dimensions From Standard Tooling (Continued)

Parker Size Number	Class III				Class IV				Class V				Class VI			
	ID	Tol ±	W	Tol ±	ID	Tol ±	W	Tol ±	ID	Tol ±	W	Tol ±	ID	Tol ±	W	Tol ±
2-313	.651	.011	.207	.007	.648	.012	.206	.007	.645	.013	.205	.008	.641	.014	.203	.008
2-314	.713	.013			.710	.013			.706	.014			.703	.015		
2-315	.774	.013			.770	.014			.767	.015			.763	.016		
2-316	.836	.013			.832	.014			.828	.015			.824	.016		
2-317	.897	.013			.893	.014			.888	.015			.884	.017		
2-318	.959	.014			.955	.015			.950	.016			.945	.017		
2-319	1.020	.014			1.015	.015			1.010	.016			1.005	.017		
2-320	1.082	.016			1.077	.017			1.071	.019			1.066	.020		
2-321	1.143	.016			1.138	.018			1.132	.019			1.126	.020		
2-322	1.205	.016			1.199	.018			1.193	.019			1.187	.021		
2-323	1.266	.017			1.260	.018			1.254	.020			1.247	.021		
2-324	1.328	.017			1.322	.018			1.315	.020			1.308	.022		
2-325	1.451	.020			1.444	.022			1.437	.024			1.429	.026		
2-326	1.574	.021			1.566	.023			1.558	.025			1.550	.027		
2-327	1.697	.021			1.689	.023			1.680	.025			1.672	.027		
2-328	1.820	.022			1.811	.024			1.802	.026			1.793	.028		
2-329	1.943	.025			1.934	.027			1.924	.030			1.914	.032		
2-330	2.066	.026			2.056	.028			2.045	.031			2.035	.033		
2-331	2.189	.026			2.178	.029			2.167	.031			2.156	.034		
2-332	2.312	.026			2.301	.029			2.289	.032			2.277	.035		
2-333	2.435	.029			2.423	.032			2.411	.035			2.398	.038		
2-334	2.558	.029			2.545	.032			2.532	.036			2.519	.039		
2-335	2.681	.030			2.668	.033			2.654	.036			2.641	.040		
2-336	2.804	.030			2.790	.034			2.776	.037			2.762	.041		
2-337	2.927	.035			2.913	.038			2.898	.042			2.883	.045		
2-338	3.050	.035			3.035	.039			3.019	.043			3.004	.046		
2-339	3.173	.036			3.157	.039			3.141	.043			3.125	.047		
2-340	3.296	.036			3.280	.040			3.263	.044			3.246	.048		
2-341	3.419	.037			3.402	.041			3.385	.045			3.367	.049		
2-342	3.542	.041			3.524	.045			3.506	.050			3.488	.054		
2-343	3.665	.041			3.647	.046			3.628	.050			3.610	.055		
2-344	3.788	.042			3.769	.046			3.750	.051			3.731	.056		
2-345	3.911	.042			3.892	.047			3.872	.052			3.852	.057		
2-346	4.034	.043			4.014	.048			3.993	.053			3.973	.058		
2-347	4.157	.045			4.136	.050			4.115	.055			4.094	.060		
2-348	4.280	.046			4.259	.051			4.237	.056			4.215	.061		
2-349	4.403	.046			4.381	.051			4.359	.057			4.336	.062		
2-350	4.526	.047			4.503	.052			4.480	.058			4.457	.063		
2-351	4.649	.047			4.626	.053			4.602	.058			4.579	.064		
2-352	4.772	.047			4.748	.053			4.724	.059			4.700	.065		
2-353	4.895	.055			4.871	.061			4.846	.067			4.821	.073		
2-354	5.018	.055			4.993	.061			4.967	.068			4.942	.074		
2-355	5.141	.056			5.115	.062			5.089	.068			5.063	.075		
2-356	5.264	.056			5.238	.063			5.211	.069			5.184	.076		
2-357	5.387	.057			5.360	.063			5.333	.070			5.305	.076		
2-358	5.510	.057			5.482	.064			5.454	.071			5.426	.077		
2-359	5.633	.058			5.605	.064			5.576	.071			5.548	.078		
2-360	5.756	.058			5.727	.065			5.698	.072			5.669	.079		
2-361	5.879	.059			5.850	.066			5.820	.073			5.790	.080		
2-362	6.125	.062			6.094	.070			6.063	.077			6.032	.085		
2-363	6.371	.063			6.339	.071			6.307	.079			6.274	.087		
2-364	6.617	.064			6.584	.072			6.550	.080			6.517	.088		
2-365	6.863	.065			6.829	.073			6.794	.082			6.759	.090		
2-366	7.109	.071			7.073	.080			7.037	.088			7.001	.097		
2-367	7.355	.072	.207	.007	7.318	.081	.206	.007	7.281	.090	.205	.008	7.243	.099	.203	.008

Table 10-8: Dimensions From Standard Tooling

WARNING: These products can expose you to chemicals including carbon black (airborne and extracts), antimony trioxide, titanium dioxide, silica (crystalline), di(2-ethylhexyl) phthalate, ethylene thiourea, acrylonitrile, 1,3-butadiene, epichlorohydrin, toluenediisocyanate, tetrafluoroethylene, ethylbenzene, formaldehyde, furfuryl alcohol, glass fibers, methyl isobutyl ketone, nickel (metallic and compounds), lead and lead compounds which are known to the State of California to cause cancer; and 1,3-butadiene, epichlorohydrin, di(2-ethylhexyl)phthalate, di-isodecyl phthalate, ethylene thiourea, methyl isobutyl ketone, methanol, toluene, lead and lead compounds which are known to the State of California to cause birth defects and other reproductive harm. For more information go to www.P65Warnings.ca.gov.

Dimensions From Standard Tooling (Continued)

Parker Size Number	Class -1				Class AN				Class I				Class II			
	ID	Tol ±	W	Tol ±	ID	Tol ±	W	Tol ±	ID	Tol ±	W	Tol ±	ID	Tol ±	W	Tol ±
2-368	7.771	.045	.211	.005	7.725	.045	.210	.005	7.679	.054	.209	.006	7.640	.064	.208	.007
2-369	8.023	.045			7.975	.045			7.927	.055			7.887	.064		
2-370	8.274	.050			8.225	.050			8.176	.060			8.135	.070		
2-371	8.526	.050			8.475	.050			8.424	.060			8.382	.070		
2-372	8.777	.050			8.725	.050			8.673	.060			8.629	.071		
2-373	9.029	.050			8.975	.050			8.921	.061			8.876	.072		
2-374	9.280	.055			9.225	.055			9.170	.066			9.124	.077		
2-375	9.532	.055			9.475	.055			9.418	.066			9.371	.078		
2-376	9.783	.055			9.725	.055			9.667	.067			9.618	.078		
2-377	10.035	.055			9.975	.055			9.915	.067			9.865	.079		
2-378	10.538	.060			10.475	.060			10.412	.073			10.360	.085		
2-379	11.041	.060			10.975	.060			10.909	.073			10.854	.086		
2-380	11.544	.065			11.475	.065			11.406	.079			11.349	.093		
2-381	12.047	.065			11.975	.065			11.903	.079			11.843	.094		
2-382	13.053	.065			12.975	.065			12.897	.081			12.832	.096		
2-383	14.059	.070			13.975	.070			13.891	.087			13.821	.104		
2-384	15.065	.070			14.975	.070			14.885	.088			14.810	.106		
2-385	16.051	.075			15.955	.075			15.859	.094			15.779	.113		
2-386	17.057	.080			16.955	.080			16.853	.100			16.768	.121		
2-387	18.063	.085			17.955	.085			17.847	.107			17.757	.128		
2-388	19.069	.090			18.955	.090			18.841	.113			18.746	.135		
2-389	20.075	.095			19.955	.095			19.835	.119			19.735	.143		
2-390	21.081	.095			20.955	.095			20.829	.120			20.724	.145		
2-391	22.087	.100			21.955	.100			21.823	.126			21.713	.153		
2-392	23.078	.105			22.940	.105			22.802	.133			22.688	.160		
2-393	24.084	.110			23.940	.110			23.796	.139			23.677	.167		
2-394	25.090	.115			24.940	.115			24.790	.145			24.666	.175		
2-395	26.096	.120			25.940	.120			25.784	.151			25.655	.182		
2-425	4.502	.033	.277	.006	4.475	.033	.275	.006	4.448	.038	.273	.007	4.426	.044	.272	.008
2-426	4.628	.033			4.600	.033			4.572	.039			4.549	.044		
2-427	4.753	.033			4.725	.033			4.697	.039			4.673	.044		
2-428	4.879	.033			4.850	.033			4.821	.039			4.797	.045		
2-429	5.005	.037			4.975	.037			4.945	.043			4.920	.049		
2-430	5.131	.037			5.100	.037			5.069	.043			5.044	.049		
2-431	5.256	.037			5.225	.037			5.194	.043			5.168	.050		
2-432	5.382	.037			5.350	.037			5.318	.043			5.291	.050		
2-433	5.508	.037			5.475	.037			5.442	.044			5.415	.050		
2-434	5.634	.037			5.600	.037			5.566	.044			5.538	.050		
2-435	5.759	.037			5.725	.037			5.691	.044			5.662	.050		
2-436	5.885	.037			5.850	.037			5.815	.044			5.786	.051		
2-437	6.011	.037			5.975	.037			5.939	.044			5.909	.051		
2-438	6.262	.040			6.225	.040			6.188	.047			6.157	.055		
2-439	6.514	.040			6.475	.040			6.436	.048			6.404	.056		
2-440	6.765	.040			6.725	.040			6.685	.048			6.651	.056		
2-441	7.017	.040			6.975	.040			6.933	.048			6.898	.057		
2-442	7.268	.045			7.225	.045			7.182	.054			7.146	.062		
2-443	7.520	.045			7.475	.045			7.430	.054			7.393	.063		
2-444	7.771	.045			7.725	.045			7.679	.054			7.640	.064		
2-445	8.023	.045			7.975	.045			7.927	.055			7.887	.064		
2-446	8.274	.055			8.225	.055			8.176	.060			8.135	.070		
2-447	9.029	.055			8.975	.055			8.921	.066			8.876	.077		
2-448	9.532	.055			9.475	.055			9.418	.066			9.371	.078		
2-449	10.035	.055			9.975	.055			9.915	.067			9.865	.079		
2-450	10.538	.060			10.475	.060			10.412	.073			10.360	.085		
2-451	11.041	.060	.277	.006	10.975	.060	.275	.006	10.909	.073	.273	.007	10.854	.086	.272	.008

Table 10-8: Dimensions From Standard Tooling

WARNING: These products can expose you to chemicals including carbon black (airborne and extracts), antimony trioxide, titanium dioxide, silica (crystalline), di(2-ethylhexyl) phthalate, ethylene thiourea, acrylonitrile, 1,3-butadiene, epichlorohydrin, toluenediisocyanate, tetrafluoroethylene, ethylbenzene, formaldehyde, furfuryl alcohol, glass fibers, methyl isobutyl ketone, nickel (metallic and compounds), lead and lead compounds which are known to the State of California to cause cancer; and 1,3-butadiene, epichlorohydrin, di(2-ethylhexyl)phthalate, di-isodecyl phthalate, ethylene thiourea, methyl isobutyl ketone, methanol, toluene, lead and lead compounds which are known to the State of California to cause birth defects and other reproductive harm. For more information go to www.P65Warnings.ca.gov.

Dimensions From Standard Tooling (Continued)

Parker Size Number	Class III				Class IV				Class V				Class VI			
	ID	Tol ±	W	Tol ±	ID	Tol ±	W	Tol ±	ID	Tol ±	W	Tol ±	ID	Tol ±	W	Tol ±
2-368	7.601	.073	.207	.007	7.563	.082	.206	.007	7.524	.091	.205	.008	7.486	.101	.203	.008
2-369	7.847	.074			7.808	.083			7.768	.093			7.728	.102		
2-370	8.093	.080			8.052	.089			8.011	.099			7.970	.109		
2-371	8.339	.081			8.297	.091			8.255	.101			8.212	.111		
2-372	8.585	.081			8.542	.092			8.498	.102			8.455	.133		
2-373	8.831	.082			8.787	.093			8.742	.104			8.697	.115		
2-374	9.077	.088			9.031	.099			8.985	.110			8.939	.121		
2-375	9.323	.089			9.276	.100			9.229	.112			9.181	.123		
2-376	9.569	.090			9.521	.102			9.472	.113			9.424	.125		
2-377	9.815	.091			9.766	.103			9.716	.115			9.666	.127		
2-378	10.307	.098			10.255	.110			10.203	.123			10.150	.135		
2-379	10.799	.100			10.745	.113			10.690	.126			10.635	.139		
2-380	11.291	.106			11.234	.120			11.177	.134			11.119	.148		
2-381	11.783	.108			11.724	.122			11.664	.137			11.604	.151		
2-382	12.767	.112			12.703	.127			12.638	.143			12.573	.158		
2-383	13.751	.120			13.682	.137			13.612	.154			13.542	.171		
2-384	14.735	.124			14.661	.142			14.586	.160			14.511	.178		
2-385	15.700	.132			15.620	.152			15.540	.171			15.460	.190		
2-386	16.684	.141			16.599	.161			16.514	.182			16.429	.202		
2-387	17.668	.150			17.578	.171			17.488	.193			17.398	.214		
2-388	18.652	.158			18.557	.181			18.462	.204			18.367	.226		
2-389	19.636	.167			19.536	.191			19.436	.215			19.336	.239		
2-390	20.620	.170			20.515	.196			20.410	.221			20.305	.246		
2-391	21.604	.179			21.494	.205			21.384	.232			21.274	.258		
2-392	22.573	.188			22.458	.215			22.344	.243			22.229	.270		
2-393	23.557	.196			23.437	.225			23.318	.254			23.198	.282		
2-934	24.541	.205	↓	↓	24.416	.235	↓	↓	24.292	.265	↓	↓	24.167	.295	↓	↓
2-395	25.525	.213	.207	.007	25.395	.245	.206	.007	25.266	.276	.205	.008	25.136	.307	.203	.008
2-425	4.403	.049	.271	.008	4.381	.054	.269	.009	4.359	.060	.268	.010	4.336	.065	.266	.010
2-426	4.526	.050			4.503	.055			4.480	.061			4.457	.066		
2-427	4.649	.050			4.626	.056			4.602	.061			4.579	.067		
2-428	4.772	.050			4.748	.056			4.724	.062			4.700	.068		
2-429	4.895	.055			4.871	.061			4.846	.067			4.821	.073		
2-430	5.018	.055			4.993	.061			4.967	.068			4.942	.074		
2-431	5.141	.056			5.115	.062			5.089	.068			5.063	.075		
2-432	5.264	.056			5.238	.063			5.211	.069			5.184	.076		
2-433	5.387	.057			5.360	.063			5.333	.070			5.305	.076		
2-434	5.510	.057			5.482	.064			5.454	.071			5.426	.077		
2-435	5.633	.058			5.605	.064			5.576	.071			5.548	.078		
2-436	5.756	.058			5.727	.065			5.698	.072			5.669	.079		
2-437	5.879	.059			5.850	.066			5.820	.073			5.790	.080		
2-438	6.125	.062			6.094	.070			6.063	.077			6.032	.085		
2-439	6.371	.063			6.339	.071			6.307	.079			6.274	.087		
2-440	6.617	.064			6.584	.072			6.550	.080			6.517	.088		
2-441	6.863	.065			6.829	.073			6.794	.082			6.759	.090		
2-442	7.109	.071			7.073	.080			7.037	.088			7.001	.097		
2-443	7.355	.072			7.318	.081			7.281	.090			7.243	.099		
2-444	7.601	.073			7.563	.082			7.524	.091			7.486	.101		
2-445	7.847	.074			7.808	.083			7.768	.093			7.728	.102		
2-446	8.339	.086			8.297	.096			8.255	.106			8.212	.116		
2-447	8.831	.087			8.787	.098			8.742	.109			8.697	.120		
2-448	9.323	.089			9.276	.100			9.229	.112			9.181	.123		
2-449	9.815	.091			9.766	.103			9.716	.115			9.666	.127		
2-450	10.307	.098	↓	↓	10.255	.110	↓	↓	10.203	.123	↓	↓	10.150	.135	↓	↓
2-451	10.799	.100	.271	.008	10.745	.113	.269	.009	10.690	.126	.268	.010	10.635	.139	.266	.010

Table 10-8: Dimensions From Standard Tooling

WARNING: These products can expose you to chemicals including carbon black (airborne and extracts), antimony trioxide, titanium dioxide, silica (crystalline), di(2-ethylhexyl) phthalate, ethylene thiourea, acrylonitrile, 1,3-butadiene, epichlorohydrin, toluenediisocyanate, tetrafluoroethylene, ethylbenzene, formaldehyde, furfuryl alcohol, glass fibers, methyl isobutyl ketone, nickel (metallic and compounds), lead and lead compounds which are known to the State of California to cause cancer; and 1,3-butadiene, epichlorohydrin, di(2-ethylhexyl)phthalate, di-isodecyl phthalate, ethylene thiourea, methyl isobutyl ketone, methanol, toluene, lead and lead compounds which are known to the State of California to cause birth defects and other reproductive harm. For more information go to www.P65Warnings.ca.gov.

Dimensions From Standard Tooling (Continued)

Parker Size Number	Class -1				Class AN				Class I				Class II			
	ID	Tol ±	W	Tol ±	ID	Tol ±	W	Tol ±	ID	Tol ±	W	Tol ±	ID	Tol ±	W	Tol ±
2-452	11.544	.060	.277	.006	11.475	.060	.275	.006	11.406	.074	.273	.007	11.349	.088	.272	.008
2-453	12.047	.060			11.975	.060			11.903	.074			11.843	.089		
2-454	12.550	.060			12.475	.060			12.400	.075			12.338	.090		
2-455	13.053	.060			12.975	.060			12.897	.076			12.832	.091		
2-456	13.556	.070			13.475	.070			13.394	.086			13.327	.102		
2-457	14.059	.070			13.975	.070			13.891	.087			13.821	.104		
2-458	14.562	.070			14.475	.070			14.388	.087			14.316	.105		
2-459	15.065	.070			14.975	.070			14.885	.088			14.810	.106		
2-460	15.568	.070			15.475	.070			15.382	.089			15.305	.107		
2-461	16.051	.075			15.955	.075			15.859	.094			15.779	.113		
2-462	16.554	.075			16.455	.075			16.356	.095			16.274	.114		
2-463	17.057	.080			16.955	.080			16.853	.100			16.768	.121		
2-464	17.560	.085			17.455	.085			17.350	.106			17.263	.127		
2-465	18.063	.085			17.955	.085			17.847	.107			17.757	.128		
2-466	18.566	.085			18.455	.085			18.344	.107			18.252	.129		
2-467	19.069	.090			18.955	.090			18.841	.113			18.746	.135		
2-468	19.572	.090			19.455	.090			19.338	.113			19.241	.137		
2-469	20.075	.095			19.955	.095			19.835	.119			19.735	.143		
2-470	21.081	.095			20.955	.095			20.829	.120			20.724	.145		
2-471	22.087	.100			21.955	.100			21.823	.126			21.713	.153		
2-472	23.078	.105			22.940	.105			22.802	.133			22.688	.160		
2-473	24.084	.110			23.940	.110			23.796	.139			23.677	.167		
2-474	25.090	.115			24.940	.115			24.790	.145			24.666	.175		
2-475	26.096	.120	.277	.006	25.940	.120	.275	.006	25.784	.151	.273	.007	25.655	.182	.272	.008

Parker Size Number	Class -1				Class AN				Class I				Class II			
	ID	Tol ±	W	Tol ±	ID	Tol ±	W	Tol ±	ID	Tol ±	W	Tol ±	ID	Tol ±	W	Tol ±
3-901	.186	.005	.056	.003	.185	.005	.056	.003	.184	.005	.056	.004	.183	.005	.055	.004
3-902	.240	.005	.064		.239	.005	.064		.238	.005	.064		.236	.006	.063	
3-903	.303	.005	.064		.301	.005	.064		.299	.005	.064		.298	.006	.063	
3-904	.353	.005	.072		.351	.005	.072		.349	.005	.072		.347	.006	.071	
3-905	.416	.005	.072		.414	.005	.072		.412	.005	.072		.409	.006	.071	
3-906	.471	.005	.078		.468	.005	.078		.465	.006	.078		.463	.006	.077	
3-907	.533	.007	.082		.530	.007	.082		.527	.008	.082		.524	.008	.081	
3-908	.648	.009	.088		.644	.009	.087		.640	.010	.086		.637	.011	.086	
3-909	.710	.009	.098		.706	.009	.097		.702	.010	.096		.698	.011	.096	
3-910	.760	.009	.098		.755	.009	.097		.750	.010	.096		.747	.011	.096	
3-911	.868	.009	.117		.863	.009	.116		.858	.010	.115		.854	.011	.115	
3-912	.930	.009	.117		.924	.009	.116		.918	.010	.115		.914	.011	.115	
3-913	.992	.010	.117		.986	.010	.116		.980	.011	.115		.975	.012	.115	
3-914	1.053	.010	.117		1.047	.010	.116		1.041	.011	.115		1.035	.013	.115	
3-916	1.178	.010	.117		1.171	.010	.116		1.164	.011	.115		1.158	.013	.115	
3-918	1.363	.012	.117		1.355	.012	.116		1.347	.014	.115		1.340	.015	.115	
3-920	1.484	.014	.119		1.475	.014	.118		1.466	.016	.117		1.459	.018	.117	
3-924	1.730	.014	.119		1.720	.014	.118		1.710	.016	.117		1.701	.018	.117	
3-928	2.103	.018	.119		2.090	.018	.118		2.077	.021	.117		2.067	.023	.117	
3-932	2.351	.018	.119	.004	2.337	.018	.118	.004	2.323	.021	.117	.005	2.311	.024	.117	.005

Table 10-8: Dimensions From Standard Tooling

WARNING: These products can expose you to chemicals including carbon black (airborne and extracts), antimony trioxide, titanium dioxide, silica (crystalline), di(2-ethylhexyl) phthalate, ethylene thiourea, acrylonitrile, 1,3-butadiene, epichlorohydrin, toluenediisocyanate, tetrafluoroethylene, ethylbenzene, formaldehyde, furfuryl alcohol, glass fibers, methyl isobutyl ketone, nickel (metallic and compounds), lead and lead compounds which are known to the State of California to cause cancer; and 1,3-butadiene, epichlorohydrin, di(2-ethylhexyl)phthalate, di-isodecyl phthalate, ethylene thiourea, methyl isobutyl ketone, methanol, toluene, lead and lead compounds which are known to the State of California to cause birth defects and other reproductive harm. For more information go to www.P65Warnings.ca.gov.

Dimensions From Standard Tooling (Continued)

Parker Size Number	Class III				Class IV				Class V				Class VI			
	ID	Tol ±	W	Tol ±	ID	Tol ±	W	Tol ±	ID	Tol ±	W	Tol ±	ID	Tol ±	W	Tol ±
2-452	11.291	.101	.271	.008	11.234	.115	.269	.009	11.177	.129	.268	.010	11.119	.143	.266	.010
2-453	11.783	.103			11.724	.117			11.664	.132			11.604	.146		
2-454	12.275	.105			12.213	.120			12.151	.135			12.088	.150		
2-455	12.767	.107			12.703	.122			12.638	.138			12.573	.153		
2-456	13.259	.119			13.192	.135			13.125	.151			13.057	.167		
2-457	13.751	.120			13.682	.137			13.612	.154			13.542	.171		
2-458	14.243	.122			14.171	.139			14.099	.157			14.026	.174		
2-459	14.735	.124			14.661	.142			14.586	.160			14.511	.178		
2-460	15.227	.126			15.150	.144			15.073	.163			14.995	.181		
2-461	15.700	.132			15.620	.152			15.540	.171			15.460	.190		
2-462	16.192	.134			16.109	.154			16.027	.174			15.945	.193		
2-463	16.684	.141			16.599	.161			16.514	.182			16.429	.202		
2-464	17.176	.148			17.088	.169			17.001	.190			16.914	.211		
2-465	17.668	.150			17.578	.171			17.488	.193			17.398	.214		
2-466	18.160	.151			18.067	.174			17.975	.196			17.883	.218		
2-467	18.652	.158			18.557	.181			18.462	.204			18.367	.226		
2-468	19.144	.160			19.046	.183			18.949	.207			18.852	.230		
2-469	19.636	.167			19.536	.191			19.436	.215			19.336	.239		
2-470	20.620	.170			20.515	.196			20.410	.221			20.305	.246		
2-471	21.604	.179			21.494	.205			21.384	.232			21.274	.258		
2-472	22.573	.188			22.458	.215			22.344	.243			22.229	.270		
2-473	23.557	.196			23.437	.225			23.318	.254			23.198	.282		
2-474	23.541	.205			24.416	.235			24.292	.265			24.167	.295		
2-475	25.525	.213	.271	.008	25.395	.245	.269	.009	25.266	.276	.268	.010	25.136	.307	.266	.010

Parker Size Number	Class III				Class IV				Class V				Class VI			
	ID	Tol ±	W	Tol ±	ID	Tol ±	W	Tol ±	ID	Tol ±	W	Tol ±	ID	Tol ±	W	Tol ±
3-901	.182	.006	.055	.004	.181	.006	.055	.004	.180	.006	.055	.004	.179	.006	.054	.004
3-902	.235	.006	.063		.234	.006	.063		.233	.006	.062		.232	.007	.063	
3-903	.296	.006	.063		.295	.006	.063		.293	.007	.062		.292	.007	.062	
3-904	.345	.006	.071		.344	.007	.070		.342	.007	.070		.340	.008	.070	
3-905	.407	.006	.071		.405	.007	.070		.403	.007	.070		.401	.008	.070	
3-906	.461	.007	.077		.458	.007	.076		.456	.008	.076		.453	.008	.076	
3-907	.522	.009	.081		.519	.010	.080		.516	.010	.080		.514	.011	.079	
3-908	.634	.011	.086		.630	.012	.085		.627	.013	.085		.624	.014	.084	
3-909	.695	.012	.095		.691	.012	.095		.688	.013	.094		.684	.014	.094	
3-910	.743	.012	.095	.004	.739	.013	.095	.004	.735	.014	.094	.004	.732	.014	.094	.004
3-911	.849	.012	.114	.005	.845	.013	.114	.005	.841	.014	.113	.006	.836	.015	.112	.006
3-912	.909	.012	.114		.905	.013	.114		.900	.015	.113		.895	.016	.112	
3-913	.970	.014	.114		.965	.015	.114		.960	.016	.113		.955	.017	.112	
3-914	1.030	.014	.114		1.025	.015	.114		1.020	.016	.113		1.015	.018	.112	
3-916	1.152	.014	.114		1.146	.016	.114		1.141	.017	.113		1.135	.018	.112	
3-918	1.333	.017	.114		1.327	.019	.114		1.320	.020	.113		1.313	.022	.113	
3-920	1.451	.019	.116		1.444	.021	.116		1.437	.023	.115		1.429	.025	.114	
3-924	1.692	.020	.116		1.684	.022	.116		1.675	.024	.115		1.667	.026	.114	
3-928	2.057	.026	.116		2.046	.028	.116		2.036	.031	.115		2.025	.033	.114	
3-932	2.300	.026	.116	.005	2.288	.029	.116	.005	2.276	.032	.115	.006	2.265	.035	.114	.006

Table 10-8: Dimensions From Standard Tooling

WARNING: These products can expose you to chemicals including carbon black (airborne and extracts), antimony trioxide, titanium dioxide, silica (crystalline), di(2-ethylhexyl) phthalate, ethylene thiourea, acrylonitrile, 1,3-butadiene, epichlorohydrin, toluenediisocyanate, tetrafluoroethylene, ethylbenzene, formaldehyde, furfuryl alcohol, glass fibers, methyl isobutyl ketone, nickel (metallic and compounds), lead and lead compounds which are known to the State of California to cause cancer; and 1,3-butadiene, epichlorohydrin, di(2-ethylhexyl)phthalate, di-isodecyl phthalate, ethylene thiourea, methyl isobutyl ketone, methanol, toluene, lead and lead compounds which are known to the State of California to cause birth defects and other reproductive harm. For more information go to www.P65Warnings.ca.gov.

Cross Section Tolerances

W Cross Section Range – in.	Shrinkage Class Tolerance ± inches								
	-1	AN	+I	+II	+III	+IV	+V	+VI	
.025 – .097	.003	.003	.004	.004	.004	.004	.004	.004	
.098 – .104	.003	.003	.004	.004	.004	.004	.005	.005	
.105 – .129	.004	.004	.005	.005	.005	.005	.006	.006	
.130 – .149	.004	.004	.005	.005	.005	.006	.006	.006	
.150 – .174	.005	.005	.006	.006	.007	.007	.007	.008	
.175 – .220	.005	.005	.006	.007	.007	.007	.008	.008	
.221 – .250	.006	.006	.007	.008	.008	.009	.009	.009	
.251 – .300	.006	.006	.007	.008	.008	.009	.010	.010	
.301 – .340	.007	.007	.008	.010	.010	.010	.011	.011	
.341 – .375	.007	.007	.008	.010	.010	.011	.011	.011	

W Cross Section Range – mm.	Shrinkage Class Tolerance ± millimeters								
	-1	AN	+I	+II	+III	+IV	+V	+VI	
.63 – 2.47	.08	.08	.10	.10	.10	.10	.10	.10	
2.48 – 2.65	.08	.08	.10	.10	.10	.10	.13	.13	
2.60 – 3.29	.10	.10	.13	.13	.13	.13	.15	.15	
3.30 – 3.80	.10	.10	.13	.13	.13	.15	.15	.15	
3.81 – 4.43	.13	.13	.15	.15	.18	.18	.18	.20	
4.44 – 5.60	.13	.13	.15	.18	.18	.18	.20	.20	
5.61 – 6.36	.15	.15	.18	.20	.20	.23	.23	.23	
6.37 – 7.64	.15	.15	.18	.20	.20	.23	.25	.25	
7.65 – 8.65	.18	.18	.20	.25	.25	.25	.28	.28	
8.66 – 9.55	.18	.18	.20	.25	.25	.28	.28	.28	

Table 10-9: Cross Section Tolerances

Shrinkage Class Factors

Shrinkage Class	Dimension Factor	Tolerance Factor
-1	1.006	0
AN	1.000	0
+I	.994	.0012
+II	.989	.0024
+III	.984	.0036
+IV	.979	.0048
+V	.974	.0060
+VI	.969	.0072

Table 10-10: Shrinkage Class Factors

WARNING: These products can expose you to chemicals including carbon black (airborne and extracts), antimony trioxide, titanium dioxide, silica (crystalline), di(2-ethylhexyl) phthalate, ethylene thiourea, acrylonitrile, 1,3-butadiene, epichlorohydrin, toluenediisocyanate, tetrafluoroethylene, ethylbenzene, formaldehyde, furfuryl alcohol, glass fibers, methyl isobutyl ketone, nickel (metallic and compounds), lead and lead compounds which are known to the State of California to cause cancer; and 1,3-butadiene, epichlorohydrin, di(2-ethylhexyl)phthalate, di-isodecyl phthalate, ethylene thiourea, methyl isobutyl ketone, methanol, toluene, lead and lead compounds which are known to the State of California to cause birth defects and other reproductive harm. For more information go to www.P65Warnings.ca.gov.

Tolerances for Special O-Rings with Standard Shrinkage Rates

Inside Dia. (in.)	Tol. (in.)	Inside Dia. (mm)	Tol. (mm)	Inside Dia. (in.)	Tol. (in.)	Inside Dia. (mm)	Tol. (mm)				
.027	-.060	.004	.68	1.53	.10	4.001	-.4620	.030	101.62	-.117.36	.76
.061	-.490	.005	1.54	11.69	.13	4.621	-.5560	.035	117.37	-.141.23	.89
.491	-.530	.006	11.70	14.49	.15	5.561	-.6550	.040	141.24	-.166.39	1.02
.531	-.690	.007	14.50	17.54	.18	6.551	-.7560	.045	166.40	-.192.03	1.14
.691	-.810	.008	17.55	20.59	.20	7.561	-.8610	.050	192.04	-.218.70	1.27
.811	-.940	.009	20.60	23.89	.23	8.611	-.9975	.055	218.71	-.246.39	1.40
.941	-1.130	.010	23.90	28.71	.25	9.976	-11.400	.060	246.40	-.289.57	1.52
1.131	-1.400	.012	28.72	35.57	.30	11.401	-13.700	.070	289.58	-.347.99	1.78
1.401	-1.700	.014	35.58	43.17	.36	13.701	-16.100	.080	348.00	-.408.95	2.03
1.701	-2.000	.016	43.20	50.81	.41	16.101	-18.600	.090	408.96	-.472.45	2.29
2.001	-2.300	.018	50.82	58.43	.46	18.601	-22.500	.100	472.46	-.571.51	2.54
2.301	-2.620	.020	58.44	66.56	.51	22.501	-28.000	.120	571.52	-.711.21	3.05
2.621	-2.950	.022	66.57	74.94	.56	28.001	-33.700	.140	711.22	-.855.99	3.56
2.951	-3.290	.024	74.95	83.57	.61	33.701	-39.600	.160	856.00	-.1005.85	4.06
3.291	-3.630	.026	83.58	92.21	.66	39.601	-45.800	.180	1005.86	-.1163.66	4.57
3.631	-4.000	.028	92.22	101.61	.71	45.801	-52.000	.200	1163.34	-.1320.80	5.08

Table 10-11: Tolerances for Special O-Rings with Standard Shrinkage Rates

WARNING: These products can expose you to chemicals including carbon black (airborne and extracts), antimony trioxide, titanium dioxide, silica (crystalline), di(2-ethylhexyl) phthalate, ethylene thiourea, acrylonitrile, 1,3-butadiene, epichlorohydrin, toluenediisocyanate, tetrafluoroethylene, ethylbenzene, formaldehyde, furfuryl alcohol, glass fibers, methyl isobutyl ketone, nickel (metallic and compounds), lead and lead compounds which are known to the State of California to cause cancer; and 1,3-butadiene, epichlorohydrin, di(2-ethylhexyl)phthalate, di-isodecyl phthalate, ethylene thiourea, methyl isobutyl ketone, methanol, toluene, lead and lead compounds which are known to the State of California to cause birth defects and other reproductive harm. For more information go to www.P65Warnings.ca.gov.

 **WARNING:** These products can expose you to chemicals including carbon black (airborne and extracts), antimony trioxide, titanium dioxide, silica (crystalline), di(2-ethylhexyl) phthalate, ethylene thiourea, acrylonitrile, 1,3-butadiene, epichlorohydrin, toluenediisocyanate, tetrafluoroethylene, ethylbenzene, formaldehyde, furfuryl alcohol, glass fibers, methyl isobutyl ketone, nickel (metallic and compounds), lead and lead compounds which are known to the State of California to cause cancer; and 1,3-butadiene, epichlorohydrin, di(2-ethylhexyl)phthalate, di-isodecyl phthalate, ethylene thiourea, methyl isobutyl ketone, methanol, toluene, lead and lead compounds which are known to the State of California to cause birth defects and other reproductive harm. For more information go to www.P65Warnings.ca.gov.

Index

— A —

Abbreviations	10-15
Abrasion	10-4
Abrasion Resistance	2-13
Accessories	3-6
Acids	3-22
Acrylonitrile-Butadiene (NBR)	2-3
Advantages of O-Rings	1-2
Aerospace Technology	3-13
Age Control	2-21
Aged Physical Control	2-30
Aging	2-21
Air Conditioning	3-12
Aniline Point Differences	2-22
Anti-Extrusion Device Design Hints	6-2
Applications Summary	3-25
Assembly	3-7
Assembly Hints	10-5
Automotive	3-10

— B —

Back-Up Rings	5-14, 6-2
Other Materials	6-2
Polytetrafluoroethylene (PTFE) Back-Up Rings	6-2
Boss Seals	4-3
Boss Seals, Tube Fitting	4-22
Brake System	3-10
Break-Out Friction	5-7
Butyl Rubber (IIR)	2-4

— C —

Carboxylated Nitrile (XNBR)	2-4
Calculate Rubbing Surface	5-8
Calculation of Drive Belt Open Design	5-20
Calculation of Drive Belt Crossed Design	5-21
Chamfers	10-5
Chloroprene Rubber (CR)	2-5
Cleanliness	3-7
Cleanliness and Cleaning Materials	10-6
Coefficient	
of Friction	2-19
of Thermal Expansion	2-19
Comparison of Common Seal Types	1-7
Compatibility Tables for Gases, Fluids and Solids	7-2
Compatibility Prediction, Rapid	2-22
Compound	2-3
Selection	2-7, 2-22
Shrinkage Class	10-17
Similarity	2-28
Specifications for Commonly Used SAE and ASTM Specifications	8-6

Compression Set	2-14, 10-2
Compression Force	2-10, 3-9
Concentrates Containing Mineral Oils (Oil-in-Water-Solutions)	3-17
Contact Surfaces, Plastic	3-22
Cooling & Heating Systems	3-11
Corrosion	2-18
Crush Installation	1-6
Cure Date	2-21
Cushion Installation	1-6
Custom Molded Shapes	1-6

— D —

Design Procedure	
Recommended Design Procedure	1-7
Recommended Manual Design Procedure	1-7
Deterioration	2-18
Dimensions from Standard Tooling	10-18
Dovetail and Half-Dovetail Grooves	4-3
Dovetail Grooves	4-19
Half Dovetail Grooves	4-20
Drive Belt Compounds	
Available	3-24
Selection	3-24
Drive Belts	3-24, 5-20
O-Rings as Drive Belts	1-6
Dynamic Vacuum Sealing	5-44

— E —

Early Stress Aging	5-15
Effects of Environment on Testing	2-20
Effects on Properties	2-20
Elastomers	2-2, 2-3
Elastomer Compatibility Index	2-23
Elastomers for O-Ring Seals	2-3
Introduction to Elastomers	2-2
Electrical Properties	2-19
Elongation	2-10
Energy, Oil & Gas	3-14
Engine	3-10
Environment, effects on properties	2-20
Ethylene Acrylate (AEM) (Vamac)	2-4
Ethylene Propylene Rubber (EPM, EPDM)	2-4
Excessive Swell (above 20%)	5-15
Explosive Decompression	10-4
Extraction Tools	3-6
Extrusion	3-3
Extrusion and Nibbling	10-3

WARNING: These products can expose you to chemicals including carbon black (airborne and extracts), antimony trioxide, titanium dioxide, silica (crystalline), di(2-ethylhexyl) phthalate, ethylene thiourea, acrylonitrile, 1,3-butadiene, epichlorohydrin, toluenediisocyanate, tetrafluoroethylene, ethylbenzene, formaldehyde, furfuryl alcohol, glass fibers, methyl isobutyl ketone, nickel (metallic and compounds), lead and lead compounds which are known to the State of California to cause cancer; and 1,3-butadiene, epichlorohydrin, di(2-ethylhexyl)phthalate, di-isodecyl phthalate, ethylene thiourea, methyl isobutyl ketone, methanol, toluene, lead and lead compounds which are known to the State of California to cause birth defects and other reproductive harm. For more information go to www.P65Warnings.ca.gov.

– F –

Face Seal Glands 4-18
 Face Type O-Ring Seals 4-2
 Factors Applying to All O-Ring Types 3-2
 Failure, Premature 10-2
 Failure Mode and Effects Analysis
 for Customers 10-6
 Failures and Leakage 4-3
 Fire-Resistant Hydraulic Fluids 3-15
 Floating Glands 5-15
 Floating Seal 5-16
 Fluid 2-24
 Fluid Compatibility Table 7-2
 Fluorocarbon (FKM, FPM) 2-5
 Fluorosilicone (FVMQ) 2-5
 Food, Beverage and Potable Water 3-12
 Friction 5-7, 5-8
 Friction, Coefficient of 2-19
 Friction and Wear 5-8
 Friction Reduction Methods, Other 3-5
 Fuel System 3-10
 Fuels for Automobile Engines 3-11
 Jet Fuels 3-13
 Fungus-Resistant Compounds 3-15

– G –

Gap 1-3
 Gas Compatibility Table 7-2
 Gases-High Pressure 3-21
 Gases-Permeability 3-20
 Gland Dimensions 5-16
 Gland Dimensions for
 Reciprocating Hydraulic O-Ring Seals 5-15
 Gland Fill 3-9
 Glossary of Seal and Rubber Terms 10-9

– H –

Half Dovetail Grooves 4-20
 Hardness 2-9
 HFA Fluids 3-15
 HFC Fluids 3-17
 HFD Fluids 3-17
 High-Pressure 5-16
 High Frequency Motion or Vibration 5-6
 High Temperature 3-17
 Hydraulic Fluids 3-15
 Hydraulic Reciprocating O-Ring Seals 5-2
 Hydrogenated Nitrile (HNBR, HSN) 2-5

– I –

inPHorm Seal Design and
 Material Selection Software 3-24
 Inside Diameters, Cross Sections and Tolerances
 For Aerospace Applications -
 Series A (ISO 3601-1) 9-19

For Aerospace Applications -
 Series G (ISO 3601-1) 9-20
 Installation Damage 10-5
 Interdependence of Friction Wear
 and an Effective Seal 5-12
 Internal Lubrication 3-5
 ISO 3601-1, Series A Sizes 9-19
 ISO 3601-1, Series G Sizes 9-20
 ISO 6149 O-Rings for Metric Tube Fittings 9-25

– J –

Jet Fuels 3-13
 JIS B2401 Sizes 9-21
 Joule Effect 2-18

– L –

Leak Rate Approximation 3-21
 Leakage, Small Amounts 5-15
 Leather Back-Up Rings 6-3
 Length of Stroke 5-14
 Liquid Rocket Propellants 3-13
 Low Temperature 3-18
 Low Temperature Leakage 5-15
 Lubrication 3-4, 5-16
 Lack of Lubrication 5-14

– M –

Mechanical Requirements 2-28
 Metal Non-Extrusion Rings 6-3
 Methods to Reduce Friction 5-8
 Micro-Emulsions 3-17
 Military Fluid Specification Description 8-3
 Military Rubber Specifications 8-4
 Modifications for Special Applications 5-14
 Modulus 2-13
 Molded Elastomeric O-Ring Quality Pass/Fail Limits 2-13

– N –

National Sanitation Foundation (NSF) 3-13
 Non-Pioneering Design 2-22
 Nuclear Technology 3-14
 Numbering System 8-2

– O –

O-Lube 3-4
 O-Ring
 Advantages 1-2
 Assembly 3-7
 Characteristics 1-3
 Cleanliness 3-7
 Definition 1-2
 O-Ring
 Failures and Leakage 4-3
 How To Order O-Rings and Other Parts 8-2

⚠ WARNING: These products can expose you to chemicals including carbon black (airborne and extracts), antimony trioxide, titanium dioxide, silica (crystalline), di(2-ethylhexyl) phthalate, ethylene thiourea, acrylonitrile, 1,3-butadiene, epichlorohydrin, toluenediisocyanate, tetrafluoroethylene, ethylbenzene, formaldehyde, furfuryl alcohol, glass fibers, methyl isobutyl ketone, nickel (metallic and compounds), lead and lead compounds which are known to the State of California to cause cancer; and 1,3-butadiene, epichlorohydrin, di(2-ethylhexyl)phthalate, di-isodecyl phthalate, ethylene thiourea, methyl isobutyl ketone, methanol, toluene, lead and lead compounds which are known to the State of California to cause birth defects and other reproductive harm. For more information go to www.P65Warnings.ca.gov.

– S –

Scope of O-Ring Use	1-4
Seat Seal	1-5, 5-19
Selecting a Compound	2-28
Selecting the Best Cross-Section	3-7
Selection of Base Polymer	2-7
Semiconductor	3-24
Series 2-XXX O-Ring Sizes	9-2
Series 3-XXX O-Ring Sizes	9-11
Series 5-XXX Locator Table	9-17
Series 5-XXX O-Ring Sizes	9-12
Shape of Groove and Split Groove	5-14
Sharp Edges	10-6
Shelf Aging	2-24
Shock Loads and Pressures	5-5
Shrinkage	2-21
Shrinkage, Standard	10-16
Side Loads	5-5
Silicone Compounds	5-16
Silicone Fluids	3-22
Silicone Rubber (Q, MQ, VMQ, PVMQ)	2-6
Sizes, O-Rings	9-2
2-series	9-2
3-series	9-11
5-series	9-12
Series A (Aerospace) (ISO 3601)	9-19
Series G (Aerospace) (ISO 3601)	9-20
JIS B2401	9-21
Small Amount of Leakage	5-15
Solids Compatibility Table	7-2
Specific Applications	3-10
Specifications	2-29
Specifications, SAE and ASTM	8-6
Speed of Stroke	5-14
Spiral Failure	5-13, 10-3
Squeeze	3-9, 5-6, 5-14
Standard Test Procedures	2-20
Static Male and Female O-Ring Design	4-2
Static Seals	1-5
Storage	2-21
Stress-Aging, Early	5-15
Stretch	3-8, 5-6
Stretching for Assembly	10-6
Super O-Lube	3-4
Surface Finish	5-14
Surface Finishes	5-3
For Static O-Ring Seals	4-2
Swell, excessive (above 20%)	5-15
Synthetic HFA Concentrates (Solutions)	3-17

– T –

Tear Resistance	2-13
Temperature	2-25, 3-3, 5-16
Temperature of Operation	5-14
Temperature Effects on Dynamic Seals	5-5
Temperature Extremes	3-17
Tensile Strength	2-10
Test Method Variables	2-20
Test Specimens	2-20
Testing	2-28
Effects of Environment	2-20
Original Physical Properties	2-30
Durometer	2-30
Elongation	2-30
Modulus	2-30
Specific Gravity	2-30
Tensile Strength	2-30
Aged Physical Control	2-30
Compression Set	2-31
Elongation Change	2-31
Hardness Change	2-30
Low Temperature Resistance	2-31
Tensile Strength Change	2-30
Volume Change	2-31
Tetrafluoroethylene-Propylene (AFLAS)	2-6
Thermal Effects	2-17
Thermal Expansion	2-19
Thermal Expansion, coefficient of	2-19
Time	2-26
Toughness	2-10
Transmission	3-11
Traversing of Cross Drilled Ports	10-5
Tube Fitting Boss Seals	
- AS5205	4-22
- AS4395	4-23

– U –

Underwriters' Laboratories	3-22
Uni-Directional Gland	5-17

– V –

Vacuum	
Applications	3-19
Leak Rate	3-20
Seal Considerations	3-19
Seals	1-6
Weight Loss	3-19
Volume Change	2-13

– W –

Water and Steam Resistance	3-22
Wear	5-12

⚠ WARNING: These products can expose you to chemicals including carbon black (airborne and extracts), antimony trioxide, titanium dioxide, silica (crystalline), di(2-ethylhexyl) phthalate, ethylene thiourea, acrylonitrile, 1,3-butadiene, epichlorohydrin, toluenediisocyanate, tetrafluoroethylene, ethylbenzene, formaldehyde, furfuryl alcohol, glass fibers, methyl isobutyl ketone, nickel (metallic and compounds), lead and lead compounds which are known to the State of California to cause cancer; and 1,3-butadiene, epichlorohydrin, di(2-ethylhexyl)phthalate, di-isodecyl phthalate, ethylene thiourea, methyl isobutyl ketone, methanol, toluene, lead and lead compounds which are known to the State of California to cause birth defects and other reproductive harm. For more information go to www.P65Warnings.ca.gov.

Offer of Sale

1. **Terms and Conditions of Sale:** All descriptions, quotations, proposals, offers, acknowledgments, acceptances and sales of Seller's products are subject to and shall be governed exclusively by the terms and conditions stated herein. Buyer's acceptance of any offer to sell is limited to these terms and conditions. Any terms or conditions in addition to, or inconsistent with those stated herein, proposed by Buyer in any acceptance of an offer by Seller, are hereby objected to. No such additional, different or inconsistent terms and conditions shall become part of the contract between Buyer and Seller unless expressly accepted in writing by Seller. Seller's acceptance of any offer to purchase by Buyer is expressly conditional upon Buyer's assent to all the terms and conditions stated herein, including any terms in addition to, or inconsistent with those contained in Buyer's offer. Acceptance of Seller's products shall in all events constitute such assent.
2. **Payment:** Payment shall be made by Buyer net 30 days from the date of delivery of the items purchased hereunder. Any claims by Buyer for omissions or shortages in a shipment shall be waived unless Seller receives notice thereof within 30 days after Buyer's receipt of the shipment.
3. **Delivery:** Unless otherwise provided on the face hereof, delivery shall be made F.O.B. Seller's plant. Regardless of the method of delivery, however, risk of loss shall pass to Buyer upon Seller's delivery to a carrier. Any delivery dates shown are approximate only and Seller shall have no liability for any delays in delivery.
4. **Warranty:** Seller warrants that the items sold hereunder shall be free from defects in material or workmanship for a period of 365 days from the date of shipment to Buyer, or 2,000 hours of use, whichever expires first. THIS WARRANTY COMPRISES THE SOLE AND ENTIRE WARRANTY PERTAINING TO ITEMS PROVIDED HEREUNDER, SELLER MAKES NO OTHER WARRANTY, GUARANTEE, OR REPRESENTATION OF ANY KIND WHATSOEVER, INCLUDING BUT NOT LIMITED TO, MERCHANTABILITY AND FITNESS FOR PURPOSE, WHETHER EXPRESS, IMPLIED, OR ARISING BY OPERATION OF LAW, TRADE USAGE, OR COURSE OF DEALING ARE HEREBY DISCLAIMED.
NOTWITHSTANDING THE FOREGOING, THERE ARE NO WARRANTIES WHATSOEVER ON ITEMS BUILT OR ACQUIRED WHOLLY OR PARTIALLY, TO BUYER'S DESIGNS OR SPECIFICATIONS.
5. **Limitation of Remedy:** SELLER'S LIABILITY ARISING FROM OR IN ANY WAY CONNECTED WITH THE ITEMS SOLD OR THIS CONTRACT SHALL BE LIMITED EXCLUSIVELY TO REPAIR OR REPLACEMENT OF THE ITEMS SOLD OR REFUND OF THE PURCHASE PRICE PAID BY BUYER, AT SELLER'S SOLE OPTION. IN NO EVENT SHALL SELLER BE LIABLE FOR ANY INCIDENTAL, CONSEQUENTIAL OR SPECIAL DAMAGES OF ANY KIND OR NATURE WHATSOEVER, INCLUDING BUT NOT LIMITED TO LOST PROFITS ARISING FROM OR IN ANY WAY CONNECTED WITH THIS AGREEMENT OR ITEMS SOLD HEREUNDER, WHETHER ALLEGED TO RISE FROM BREACH OF CONTRACT, EXPRESS OR IMPLIED WARRANTY, OR IN TORT, INCLUDING WITHOUT LIMITATION, NEGLIGENCE, FAILURE TO WARN OR STRICT LIABILITY.
6. **Changes, reschedules and Cancellations:** Buyer may request to modify the designs or specifications for the items sold hereunder as well as the quantities and delivery dates thereof, or may request to cancel all or part of this order, however, no such requested modification or cancellation shall become part of the contract between Buyer and Seller unless accepted by Seller in a written amendment to this Agreement. Acceptance of any such requested modification or cancellation shall be at Seller's discretion, and shall be upon such terms and conditions as Seller may require.
7. **Special Tooling:** A tooling charge may be imposed for any special tooling, including without limitation, dies, fixtures, molds and patterns, acquired to manufacture items sold pursuant to this contract. Such special tooling shall be and remain Seller's property notwithstanding payment of any charges by Buyer. In no event will Buyer acquire any interest in apparatus belonging to Seller which is utilized in the manufacture of the items sold hereunder, even if such apparatus has been specially converted or adapted for such manufacture and notwithstanding any charges paid by Buyer. Unless otherwise agreed, Seller shall have the right to alter, discard or otherwise dispose of any special tooling or other property in its sole discretion at any time.
8. **Buyer's Property:** Any designs, tools, patterns, materials, drawings, confidential information or equipment furnished by Buyer or any other items which become Buyer's property, may be considered obsolete and may be destroyed by Seller after two (2) consecutive years have elapsed without Buyer placing an order for the items which are manufactured using such property. Seller shall not be responsible for any loss or damage to such property while it is in Seller's possession or control.
9. **Taxes:** Unless otherwise indicated on the face hereof, all prices and charges are exclusive of excise, sales, use, property, occupational or like taxes which may be imposed by any taxing authority upon the manufacture, sale or delivery of the items sold hereunder. If any such taxes must be paid by Seller or if Seller is liable for the collection of such tax, the amount thereof shall be in addition to the amounts for the items sold. Buyer agrees to pay all such taxes or to reimburse Seller therefor upon receipt of its invoice. If Buyer claims exemption from any sales, use or other tax imposed by any taxing authority, Buyer shall save Seller harmless from and against any such tax, together with any interest or penalties thereon which may be assessed if the items are held to be taxable.
10. **Indemnity For Infringement of Intellectual Property Rights:** Seller shall have no liability for infringement of any patents, trademarks, copyrights, trade secrets or similar rights except as provided in this Part 10. Seller will defend and indemnify Buyer against allegations of infringement of U.S. patents, U.S. trademarks, copyrights, and trade secrets (hereinafter 'Intellectual Property Rights'). Seller will defend at its expense and will pay the cost of any settlement or damages awarded in an action brought against Buyer based on an allegation that an item sold pursuant to this contract infringes the Intellectual Property Rights of a third party. Seller's obligation to defend and indemnify Buyer is contingent on Buyer notifying Seller within ten (10) days after Buyer becomes aware of such allegations of infringement, and Seller having sole control over the defense of any allegations or actions including all negotiations for settlement or compromise. If an item sold hereunder is subject to a claim that it infringes the Intellectual Property Rights of a third party, Seller may, at its sole expense and option, procure for Buyer the right to continue using said item, replace or modify said item so as to make it noninfringing, or offer to accept return of said item and return the purchase price less a reasonable allowance for depreciation. Notwithstanding the foregoing, Seller shall have no liability for claims of infringement based on information provided by Buyer, or directed to items delivered hereunder for which the designs are specified in whole or part by Buyer, or infringements resulting from the modification, combination or use in a system of any item sold hereunder. The foregoing provisions of this Part 10 shall constitute Seller's sole and exclusive liability and Buyer's sole and exclusive remedy for infringement of Intellectual Property Rights.
If a claim is based on information provided by Buyer or if the design for an item delivered hereunder is specified in whole or in part by Buyer, Buyer shall defend and indemnify Seller for all costs, expenses or judgments resulting from any claim that such item infringes any patent, trademark, copyright, trade secret or any similar right.
11. **Force Majeure:** Seller does not assume the risk of and shall not be liable for delay or failure to perform any of Seller's obligations by reason of circumstances beyond the reasonable control of Seller (hereinafter 'Events of Force Majeure'). Events of Force Majeure shall include without limitation, accidents, acts of God, strikes or labor disputes, acts, laws, rules or regulations of any government or government agency, fires, floods, delays or failures in delivery of carriers or suppliers, shortages of materials and any other cause beyond Seller's control.
12. **Entire Agreement/Governing Law:** The terms and conditions set forth herein, together with any amendments, modifications and any different terms or conditions expressly accepted by Seller in writing, shall constitute the entire Agreement concerning the items sold, and there are no oral or other representations or agreements which pertain thereto. This Agreement shall be governed in all respects by the law of the State of Ohio. No actions arising out of the sale of the items sold hereunder or this Agreement may be brought by either party more than two (2) years after the cause of action accrues.

(PH FORM 3532) Rev. 06/00

WARNING: These products can expose you to chemicals including carbon black (airborne and extracts), antimony trioxide, titanium dioxide, silica (crystalline), di(2-ethylhexyl) phthalate, ethylene thiourea, acrylonitrile, 1,3-butadiene, epichlorohydrin, toluenediisocyanate, tetrafluoroethylene, ethylbenzene, formaldehyde, furfuryl alcohol, glass fibers, methyl isobutyl ketone, nickel (metallic and compounds), lead and lead compounds which are known to the State of California to cause cancer; and 1,3-butadiene, epichlorohydrin, di(2-ethylhexyl)phthalate, di-isodecyl phthalate, ethylene thiourea, methyl isobutyl ketone, methanol, toluene, lead and lead compounds which are known to the State of California to cause birth defects and other reproductive harm. For more information go to www.P65Warnings.ca.gov.



WARNING: These products can expose you to chemicals including carbon black (airborne and extracts), antimony trioxide, titanium dioxide, silica (crystalline), di(2-ethylhexyl) phthalate, ethylene thiourea, acrylonitrile, 1,3-butadiene, epichlorohydrin, toluenediisocyanate, tetrafluoroethylene, ethylbenzene, formaldehyde, furfuryl alcohol, glass fibers, methyl isobutyl ketone, nickel (metallic and compounds), lead and lead compounds which are known to the State of California to cause cancer; and 1,3-butadiene, epichlorohydrin, di(2-ethylhexyl)phthalate, di-isodecyl phthalate, ethylene thiourea, methyl isobutyl ketone, methanol, toluene, lead and lead compounds which are known to the State of California to cause birth defects and other reproductive harm. For more information go to www.P65Warnings.ca.gov.

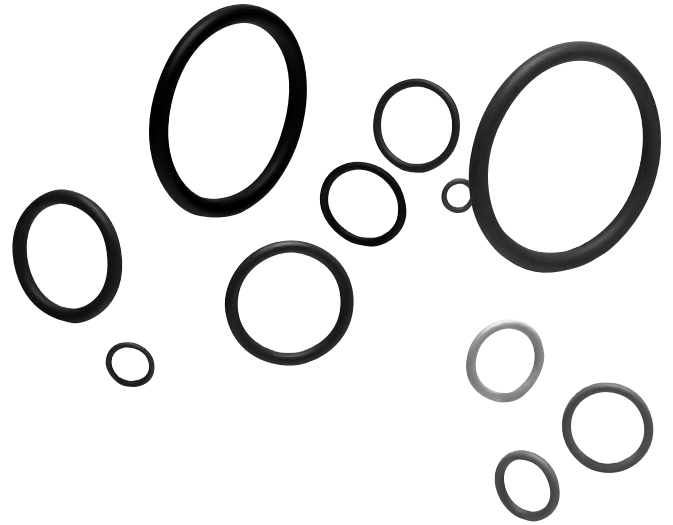

Parker's Total inPHorm

Take the guesswork out of seal design and material selection - download a copy of Parker's Total inPHorm software. Total inPHorm has many enhanced features, including an expanded media compatibility section and custom sizing capabilities that allow the user to design application-specific glands and seals.

The software automatically cross-references thousands of part numbers and recommends materials based on the requirements of MIL, SAE and other standards. Total InPhorm takes the seal designer from concept to completion. In addition to the popular O-Ring package, Total inPHorm contains four other standalone packages for hydraulic and pneumatic sealing applications, static face sealing, standard composite seal products and EMI shielding and thermal management.

To download your copy of Parker's Total inPHorm, visit www.parkerorings.com.



WARNING: These products can expose you to chemicals including carbon black (airborne and extracts), antimony trioxide, titanium dioxide, silica (crystalline), di(2-ethylhexyl) phthalate, ethylene thiourea, acrylonitrile, 1,3-butadiene, epichlorohydrin, toluenediisocyanate, tetrafluoroethylene, ethylbenzene, formaldehyde, furfuryl alcohol, glass fibers, methyl isobutyl ketone, nickel (metallic and compounds), lead and lead compounds which are known to the State of California to cause cancer; and 1,3-butadiene, epichlorohydrin, di(2-ethylhexyl)phthalate, di-isodecyl phthalate, ethylene thiourea, methyl isobutyl ketone, methanol, toluene, lead and lead compounds which are known to the State of California to cause birth defects and other reproductive harm. For more information go to www.P65Warnings.ca.gov.

Table of Contents



Your Local Authorized Parker O-Ring Distributor



WARNING: These products can expose you to chemicals including carbon black (airborne and extracts), antimony trioxide, titanium dioxide, silica (crystalline), di(2-ethylhexyl)phthalate, ethylene thiourea, acrylonitrile, 1,3-butadiene, epichlorohydrin, toluenediisocyanate, tetrafluoroethylene, ethylbenzene, formaldehyde, furfuryl alcohol, glass fibers, methyl isobutyl ketone, nickel (metallic and compounds), lead and lead compounds which are known to the State of California to cause cancer; and 1,3-butadiene, epichlorohydrin, di(2-ethylhexyl) phthalate, di-isodecyl phthalate, ethylene thiourea, methyl isobutyl ketone, methanol, toluene, lead and lead compounds which are known to the State of California to cause birth defects and other reproductive harm. For more information go to www.P65Warnings.ca.gov.

6/21 10M PP AMD



Parker Hannifin Corporation
O-Ring Division
2360 Palumbo Drive
Lexington, KY 40509
Phone: (859) 269-2351
fax: (859) 335-5128

U.S. \$199.95